



Proceedings of

# CERC2011

Collaborative European Research Conference

14. - 15. January 2011

Cork, Ireland

## **Editors**

Ingo Stengel · Udo Bleimann · Bernhard Humm · Paul Walsh



# **CERC2011**

Cork, Ireland  
14–15 January 2011

Proceedings of the  
**Collaborative European  
Research Conference 2011**

Editors

Ingo Stengel  
Udo Bleimann  
Bernhard Humm  
Paul Walsh

ISSN: 2220-4164

© 2010 Cork Institute of Technology  
All rights reserved

No part of this book may be reproduced, stored in a retrieval system, or transmitted in any form or by any means – electronic, mechanical, photocopy, recording or otherwise, without the prior written permission of the publisher or distributor.

# Table of Content

## Papers

Experiences On Using Partial Least Squares (PLS) In Usability Research .....	15
<b>C. Schalles, J. Creagh, M. Rebstock</b>	
Organisational Culture: The Impact On The Merger And Acquisition Process .....	27
<b>S. Lewis, A. Wright</b>	
The Growth Of E-Procurement In Ireland: How The Private And Public Sectors Are Adapting To Purchasing On-line .....	37
<b>J. Barrett, A. Wright</b>	
Cork's Rebel Brand: A Marketing Myth Or Reality? .....	47
<b>S. Gilroy, A. Wright</b>	
Viral Marketing: The Future Next Generation .....	57
<b>V. O'Sullivan, A. Wright</b>	
Numerical Simulation And Experimental Validation Of A Transmission Cable Statistical Fault Identification Method .....	73
<b>C. Healy, R. A. Guinee</b>	
Design And Development Of Embeddable Wireless Sensors For Concrete Curring And Structural Health.....	89
<b>W. Quinn, P. Angove, J. Buckley, G. Kelly, J. Barrett</b>	
Turbidity Based Suspended Sediment Fluxes In The Owenabue Catchment, Ireland .....	101
<b>S. Harrington, J. Harrington</b>	

An Energy Balance Of Biomethane From Energy Crops In Ireland .....	113
<b>E. Deasy, N. Power</b>	
Finite Element Modelling Of The Response Of Hollow Core Floors To Concentrated Linear And Patch Loadings .....	125
<b>D. F. Hodge, B. D. O'Rourke, J. J. Murphy</b>	
Determination Of Moment-rotation Curves For Semi Rigid Steel End Plate Connections.....	135
<b>N. Scollard, J. J. Murphy, B. D. O'Rourke</b>	
Fit For The Future – A Semiautomatic Growing Ontology To Answer University Needs .....	145
<b>R. Böving, U. Bleimann, C. Wentzel, P. Walsh</b>	
Lessons Learned From A Control Group Experiment On Virtual Team Performance.....	155
<b>R. Friedrich, U. Bleimann, I. Stengel, P. Walsh</b>	
A Discourse On The Need For An Ethical Theory Suitable For Application Within The New Societies Of The Digital Age .....	165
<b>J. O'Sullivan</b>	
Behavioural Biometric Authentication For Mobile Devices.....	175
<b>H. Saevanee, N. L. Clarke, S. M. Furnell</b>	
Developing A Climate Change Visualization Tool Using Google SketchUp.....	185
<b>W. Lynn, P. Walsh, H. Fagan</b>	
An Evaluation Of The Technologies And Methods For The Determination Of Mean Flows In Open Channels For Assessment Of Suitability For Small Scale (<20kW) Tidal And Estuary Flow Energy Systems For Local Electricity Provision .....	195
<b>T. Daly, C. Gibbons, D. O'Reilly</b>	

Requirements Gathering For A Bioinformatics Workflow Tool ... 205  
**J. Carroll, P. Walsh, P. Rothwell, R. D. Sleator**

Campylobacter Ureolyticus  
– An Emerging Gastrointestinal Pathogen? ..... 221  
**S. Bullman, D. Corcoran, J. O’Leary,  
B. Lucey, D. Byrne, R. D. Sleator**

Design & Evaluation Of A Novel Material For  
Peripheral Nerve Regeneration ..... 233  
**X. F. Zhang, S. Kehoe, A. Burke, H. O’Shea, D. Boyd**

Development Of A Novel Oral Vaccine Against Mycobacterium  
Avium Subspecies Paratuberculosis And Johne’s Disease:  
A Patho-biotechnological Approach ..... 241  
**C. Johnston, A. Coffey, J. O’ Mahony, R. D. Sleator**

In Silico Identification Of The Principle Osmotic Stress  
Response Mechanisms Of Cronobacter Sakazakii ..... 251  
**A. Feeney, R. D. Sleator**





# Preface

Collaboration has long been the well spring of innovation and progress. Indeed some argue that what makes human kind so successful in the face of many challenges, including those of its own making, is its ability to share knowledge and ideas. CERC is a unique conference that celebrates and encourages the spirit collaboration among friends and colleagues across nations and disciplines within Europe. While CERC 2011 has resulted from recent alliances between researchers in Ireland, Germany and Great Britain, it is more rightly identified as the culmination of a partnership initiated by Dr Brendan Murphy from the Cork Institute of Technology and Prof. Udo Bleimann from the University of Applied Sciences in Darmstadt. The spirit of cooperation fostered by Dr Murphy and Prof. Bleimann has led to tangible outputs that include, research papers, MSc and PhD thesis, software applications, undergraduate and post graduate courses and many other achievements.

CERC 2011 is a fitting milestone in this journey, in that it brings together researches from science, engineering, business, humanities and the arts. This event was only made possible by the hard work of a number of people. Thanks goes to Dr Ingo Stengel for all his hard work on the program committee and for organising countless paper reviews, Prof. Udo Bleimann and Prof. Bernhard Humm for their guidance on the organising committee and Tillman Swinke and Dr. Robert Loew for their work on putting together the proceedings. Gratitude also goes to Michael Loftus for supporting this event and for fostering a culture of innovation and creativity that make events like this happen. It is fitting that CERC 2011 was held in Blackrock Castle Observatory, which has under the guidance of Dr Niall Smith and his team become a centre of science and education in Cork.

**Dr. Paul Walsh**  
**General Conference & Programme Co-Chair, CERC2011**

**Cork, January 2011**

## **CERC2011 Committees**

### **General Conference & Programme Co-Chairs**

Udo Bleimann

Cork Institute of Technology, Ireland

Paul Walsh

Cork Institute of Technology, Ireland

Ingo Stengel

University of Applied Sciences Darmstadt, Germany

Bernhard Humm

University of Applied Sciences Darmstadt, Germany

### **Organising Committee**

Paul Walsh

Ingo Stengel

Udo Bleimann

Bernhard Humm

Robert Löw

Tillman Swinke

### **International Programme Committee**

Udo Bleimann

Cork Institute of Technology, Ireland

Pat Casey

University College Cork, Ireland

Shun-Ping Chen

University of Applied Sciences Darmstadt, Germany

John Creagh

Cork Institute of Technology, Ireland

Paul Dowland

University of Plymouth, UK

Pio Fenton

Waterford Institute of Technology, Ireland

Orla Flynn

Cork Institute of Technology, Ireland

Klaus-Peter Fischer-Hellmann

University of Applied Sciences Darmstadt, Germany

Steven Furnell

University of Plymouth, UK

Paul Green

Cork Institute of Technology, Ireland

Richard Guinee

Cork Institute of Technology, Ireland

Klaus Habermehl

University of Applied Sciences Darmstadt, Germany

Joe Harrington

Cork Institute of Technology, Ireland

Bernhard Humm

University of Applied Sciences Darmstadt, Germany

Matthias Knoll

University of Applied Sciences Darmstadt, Germany

Michael Kuhn

University of Applied Sciences Darmstadt, Germany

Robert Löw

University of Applied Sciences Darmstadt, Germany

Michael Loftus

Cork Institute of Technology, Ireland

Tom Moloney

Cork Institute of Technology, Ireland

Jerry Murphy

University College Cork, Ireland

Jimmy Murphy

University College Cork, Ireland

Barry O'Connor

Cork Institute of Technology, Ireland

Gerard O'Donovan  
Cork Institute of Technology, Ireland

Walter Pauli  
University of Applied Sciences Darmstadt, Germany

Dirk Pesch  
Cork Institute of Technology, Ireland

Andy Phippen  
University of Plymouth, UK

Ian Pitt  
University College Cork, Ireland

Michael Rebstock  
University of Applied Sciences Darmstadt, Germany

Detlef Rothe  
University of Applied Sciences Darmstadt, Germany

Nicole Saenger  
University of Applied Sciences Darmstadt, Germany

Arnd Steinmetz  
University of Applied Sciences Darmstadt, Germany

Ingo Stengel  
University of Applied Sciences Darmstadt, Germany

Siobhan O'Sullivan  
Cork Institute of Technology, Ireland

Paul Walsh  
Cork Institute of Technology, Ireland

Steve Wheeler  
University of Plymouth, UK

Antje Wirth  
University of Applied Sciences Darmstadt, Germany

Angela Wright  
Cork Institute of Technology, Ireland

# CERC2011

## **Papers**

---



# Experiences on Using Partial Least Squares (PLS) in Usability Research

Schalles, Christian, Department of Computing, Cork Institute of Technology, Cork, Ireland, christian.schalles@mycit.ie

Creagh, John, Department of Computing, Cork Institute of Technology, Cork, Ireland, john.creagh@cit.ie

Rebstock, Michael, Faculty of Economics and Business Administration, University of Applied Sciences Darmstadt, Haardtring 100, 64295 Darmstadt, Germany, michael.rebstock@h-da.de

## Abstract

Detecting and accurately estimating the strength of interacting effects between latent variables are critical issues fundamental in social science research in general and particular in Information Systems Research. Partial Least Squares (PLS) has been used by a growing number of researchers from various disciplines such as strategic management, management information systems, organizational behaviour, marketing and consumer behaviour. In traditional usability research PLS has not been applied intensely. In our paper we report our experiences on using PLS in this research area.

## Keywords

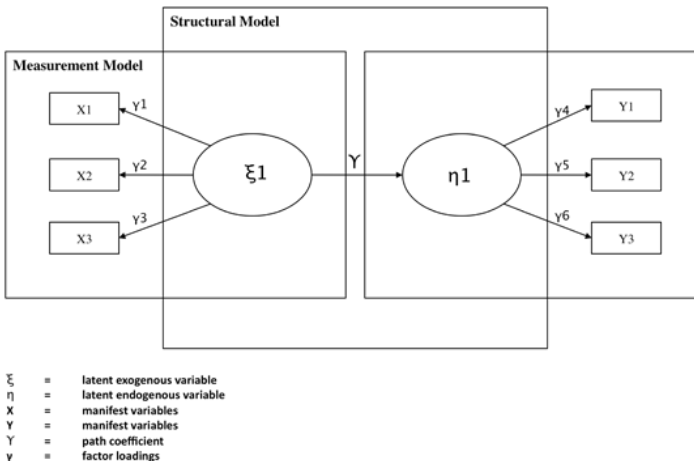
Structure Equation Modelling, Partial Least Squares, Usability

## 1. Introduction

Partial Least Squares is a statistical methodology generally based on structural equation modelling (SEM). Typically, this area of mathematical modelling represents causal processes that generate observations on multiple variables (Bentler, 1995). Structural Equation Models has been used by a growing number of researchers from various disciplines such as strategic management, management information systems, organizational behaviour, marketing and consumer behaviour (Homburg et al., 1995). In the area of usability research structural equation models have not been applied intensely. A possible reason for that might be the fact that principles of usability theory are gradually making their way to the mainstream software applications but the underlying research is less known (Ilomäki, 2008). With this paper we aim to report about our experiences using PLS in usability research. Furthermore, we give recommendations focusing on the development of structural models and the analysis of resulting causal regression weights. Our experiences are based on an empirical survey focusing on usability evaluation of graphical modelling languages conducted by Cork Institute of Technology and University of applied Sciences Darmstadt between January 2009 and August 2010.

## 2. Structure Equation Modelling

Structural equation modelling (SEM) is a statistical approach, which focuses on testing hypotheses and consequently analyzing of a structural theory bearing on some phenomenon. Particular theory represents causal interactions that generate observations on multiple latent variables. The speciality of latent variables is caused by non-direct measurability. Consequently, latent variable analysis is only possible with defining indicating variables (i.e. manifest variables) for establishing an empirical relationship. The term “structural equation modelling” transfers two essential aspects of this procedure: First, the causal processes under study are represented by a series of structural equations. Secondly, these structural relations can be modelled graphically to enable a clearer conceptualization of the theory under study. Subsequently, the hypothesized model can be tested statistically in a simultaneous analysis of the entire system of variables to determine the extent to which it is consistent with the data. If goodness-of-fit is adequate, the model argues for the plausibility of postulated relations among variables; if it is inadequate, the tenability of such relations is rejected. In general, a structural equation model consists of (1) structural relations between latent variables and (2) indicating variables for measuring latent constructs. Figure 1 shows the general structure of a structural equation model.



**Figure 1 General structure of SEM**

The measurement model formulation depends on the direction of the relationships between the latent variables and the corresponding manifest variables (Fornell et al., 1982). Consequently, two different types of measurement models are available: the reflective model (or outwards directed model) and the formative model (or inwards directed model). In a reflective model the block of manifest variables related to a latent variable is assumed to measure a unique underlying concept. Each manifest variable reflects (is an effect of) the corresponding latent variable and plays a role of endogenous variable in the block specific measurement model. In the formative model, each manifest variable or each sub-block of manifest variables represents a different dimension of the underlying concept. Therefore, unlike the reflective model, the formative model does not assume homogeneity nor unidimensionality of



the block. The latent variable is defined as a linear combination of the corresponding manifest variables, thus each manifest variable is an exogenous variable in the measurement model. The PLS-approach has been introduced as a component-based estimation procedure differing from the classical covariance-based LISREL-type approach. (Wold, 1980) provides a discussion on the theory and the application of Partial Least Squares for path models in econometrics. PLS is a component-based estimation method (Tenenhaus et al., 2005). Furthermore, it is an iterative algorithm, which (1) separately solves out the blocks of the measurement model and (2) the algorithm estimates the path coefficients in the structural model. Therefore, many researchers claim that PLS explains at best the residual variance of the latent variables and also of the manifest variables in any regression run in the model (Fornell et al., 1982). Consequently PLS is considered more as an exploratory approach than confirmatory one. In contrast to classical covariance-based approach, PLS is not targeting on reproducing the sample covariance matrix. PLS is considered as a soft modelling approach where no strong assumptions (with respect to the distributions, the sample size and the measurement scale) are required. This is a very interesting feature especially in those application fields where such assumptions are not tenable. On the other side, this implies a lack of the classical parametric inferential framework that is replaced by empirical confidence intervals and hypothesis testing procedures based on resampling methods such as jack-knife and bootstrapping (Chin et al., 2000). It also leads to less ambitious statistical properties for the estimates, e.g. coefficients are known to be biased but consistent at large.

### **3. Operationalizing Usability for PLS-Use**

#### **3.1. Definition of attributes defining Usability**

Firstly, relevant attributes defining usability are extracted and consequently operationalized. In this working phase it is essential, analyzing theoretical definitions and measurement variables for usability. The variety of definitions and measurement models of usability complicates the extraction of capable attributes of usability. A usability study would be of limited value if it would not be based on a standard definition and operationalization of usability (Coursaris et al., 2006).

The International Organization for Standardization (ISO) defines usability as the capacity of the software product to be understood, learned and attractive to the user, when it is used under specified conditions (International Organization for Standardization (ISO), 2006). Additionally, the ISO defined another standard which describes usability as the extent to which a product can be used by specified users to achieve specified goals with effectiveness, efficiency and satisfaction in a specified context of use (International Organization for Standardization (ISO), 1998).

The Institute of Electrical and Electronics Engineers (IEEE) established a standard, which describes usability as the ease a user can learn how to operate, prepare inputs for, understand and interpret the outputs of a system or component (IEEE, 1990). Dumas and Redish (1999) define that usability means quickness and simplicity regarding a user's task accomplishment. This definition is based on four assumptions: 1. Usability means focusing on users, 2. Usability includes productivity, 3. Usability means ease of use, 4. Usability means efficient task accomplishment.

Shackel (1991) associates five attributes for defining usability: speed, time to learn, retention, errors and the user specific attitude. Preece et al. (1994) combined effectiveness and efficiency to throughput. Constantine and Lockwood (1999) and Nielsen (2006) collected the attributes defining usability and developed an overall definition of usability attributes consisting of learnability, memorability, effectiveness, efficiency and user satisfaction. The variety of definitions concerning usability attributes led to the use of different terms and labels for the same usability characteristics, or different terms for similar characteristics, without full consistency across these standards; in general, the situation in the literature is similar. For example, learnability is defined in ISO 9241-11 as a simple attribute, “time of learning”, whereas ISO 9126 defines it as including several attributes such as “comprehensible input and output, instructions readiness, messages readiness [...]” (Abran et al., 2003), (International Organization for Standardization (ISO), 2004), (International Organization for Standardization (ISO), 1998).

In conclusion, we propose defining usability and related attributes as follows: Usability is specified by learnability, memorability, effectiveness, efficiency, user satisfaction and perceptibility. The learnability describes the capability of a researching object (i.e. website, application etc.) to enable the user to learn applying it. The object and properties essential for application should be easy to remember, so that a user is able to return to the object after some period of non-use without having to learn the application again. Effective application should be supported by particular object for reaching a successful task accomplishment. Objects should be efficient to use, so that a high level of working productivity is possible. Users have to be satisfied when using the object for task accomplishment. The object should offer a convenient perceptibility regarding structure, overview, elements and shapes so that able is able to search, extract and process available information in an easy way.

### 3.2. Measuring Usability Attributes

Evaluating **effectiveness** requires analysis of task output with measuring quantity and quality of goal achievement (Rengger et al., 1993). Quantity is defined as the proportion of task goals represented in the output of a task. Quality is the degree to which the task goals represented in the output have been achieved (Bevan et al., 1994). Bevan (1995) defined effectiveness as a product of quantity and quality. Transferring this, indicating manifest variables for measuring effectiveness are the grade of completeness and the grade of correctness of a task conducted in usability experiments. The **efficiency** is the amount of human, economical and temporal resources. Measures of efficiency relate to the level of effectiveness achieved to the expenditure of resources (Bevan et al., 1994). Measure values of efficiency include time taken to complete tasks, i.e. duration time for performing an experimental task (Vuolle et al., 2008). **Learnability** describes the ease of learning the application of applications, devices or websites. For this characteristic, the standard measure values are based on task completion rates and the task accuracy (Seffah et al., 2006). In general, learnability is a development and can be graphically described by learning curves (Tamir et al., 2008). Hence, learnability can be measured by the rate of difference when the user repeats evaluation sessions (Bevan, 1995). Nielsen (2006) insists that highly learnable systems could be categorized as “allowing users to reach a reasonable level of usage proficiency (...)”. Furthermore, Nielsen (2006) proposes

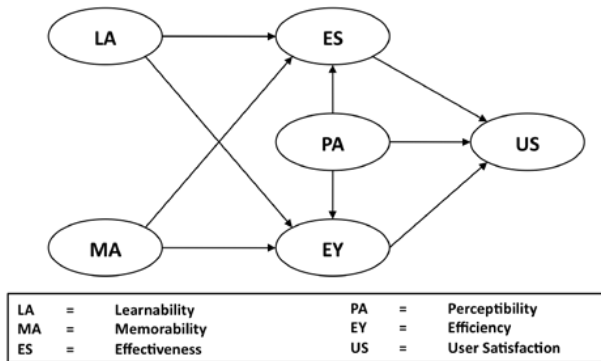
measuring proficiency by quantity and quality and of task fulfilment. Thus, we propose choosing grade of completeness and grade of correctness as basic variables for measuring learnability. With conducting two measuring points  $mp$  and  $mp+1$ , it is possible to analyze the relative difference between  $mp$  and  $mp+1$  for indicating  $\Delta$  learnability, i.e. individual learning progress in percent (Nembhard et al., 2002), (Grossman et al., 2009). The **visual perceptibility** is measured by using the method of eye-tracking with analyzing the user's visual attention (Gordon, 2004). In our research we aim to include eye-tracking for measuring user's cognitive processes i.e. information search and information extraction. The pioneering work regarding the use of eye-tracking was first carried out by Fitts et al. (1950). They proposed that fixation length is a measure of difficulty of information extraction and interpretation. Fixations are eye movements that stabilize the gaze over an object of interest. During this, the brain starts to process the visual information received from the eyes (Duchowski, 2007). The number of fixations overall is thought to be negatively correlated with search efficiency (Goldberg et al., 1999). Consequently, a larger number of fixations indicates less efficient information search in a website etc. Furthermore, we aim to analyze the difficulty of information extraction out of devices, applications and websites. Byrne et al. (1999) propose tracking fixation duration time as a measure for information extraction. From this follows that longer fixations times indicate a participant's difficulty extracting information from a website etc. Compared to the other attributes defining usability, the **individual satisfaction of a user** is a user subjective criterion that can be measured best by using standardized questionnaires (Vuolle et al., 2008). Currently no unified standardized method for measuring user satisfaction does exist. Therefore, questionnaires focusing on system and website usability were adapted (Kirakowski et al., 1993), (Armstrong et al., 2005). For evaluating user satisfaction a questionnaire, which consists of thirty items structured in 1) General impression, 2) Recommendation rate and 3) Language application was developed. The development of this questionnaire is generally contributing to the Questionnaire for User Interaction Satisfaction (QUIS) and additionally the Software Usability Measurement Inventory (SUMI) (Chin et al., 1988) (Kirakowski et al., 1993). **Memorability** is best measured as proficiency after a period of non-use provided a user has already learned a language (Olle et al., 1986), (Seffah et al., 2006). Accordingly, the measure values for memorability are neglect curves and time-delayed knowledge tests (Nembhard et al., 2000). Concerning usability, the user must remember the different elements and its intended meaning (semantics), the syntax and the application. In due consideration of Nielsen (2006), the measuring points interval should be several weeks regarding memorability.

#### 4. Developing SEM for Usability

In the following section we report our experiences on developing a structural model for usability research and furthermore applying statistical measures for assessing model quality. In general, the following section is based on experiences collected in a survey focusing on usability evaluation of graphical modelling languages. For more detailed information we refer to Schalles et al. (2010a), Schalles et al. (2010b) and Schalles et al. (2011).

#### 4.1. Developing Structural Model

Developing structural relations is the initial basis of structural equation modelling. The assumed causal relations should be based on (1) theory or (2) intrinsic logical reasons (Weiber, Mühlhaus 2010). In our study we focused on usability evaluation of graphical modelling languages. Figure 2 shows an example of a structural model including latent variables and connecting causal relations. The relations are specified by hypotheses deduced from theory.



**Figure 2 Example of causal relations between latent variables in Usability Research**

Besides, the consideration of variables influencing causal relationships between latent variables is very important when developing the structural model. These effects are called moderating variables and they are evoked by variables whose variation influences the strength or the direction of a relationship between manifest variables. Moderator variables can either be metric (e.g., user psychological constructs like experience or intelligence) or categorical (e.g., gender or education level) in nature. One example of the examination of moderating effects is a paper by (Homburg et al., 2001). They find that age and income have significant effects on the strength of the relationship between customer satisfaction and customer loyalty. In that context, age and income serve as moderator variables.

In usability context we found out that users of applications, websites etc. differ regarding their experience. This fact influences the task accomplishment and consequently the usability and has to be considered in a research model (Nielsen, 2006). Furthermore, when conducting a survey on usability evaluation, the complexity of particular tasks must be controlled and treated as moderator variables for minimizing its influence on the outcome.

#### 4.2. Model Quality Assessment

For ensuring reliability of causal estimations between different constructs in a structural model it is important to define and apply statistical quality criteria. Compared to LISREL-approach PLS path modelling does not provide any global goodness-of-fit criterion. As a consequence, (Chin, 1998) has put forward a

catalogue of criteria to assess partial model structures. A systematic application of these criteria is a two-step process, encompassing (1) the assessment of the outer model and (2) the assessment of the inner model. Concerning this, it is important to distinguish between reflective and formative measurement models. Usually, the first criterion checked is internal consistency reliability. The traditional criterion for internal consistency is Cronbach's Alpha, which provides an estimate for the reliability based on the indicator intercorrelations (Cronbach, 1951).

**Table 1 Proposed Quality Metrics for Measurement Model**

Criterion	Model Type	Measuring Model quality metrics
Cronbach's Alpha	R	Cronbach's Alpha provides an estimate for the reliability based on the indicator intercorrelations. Values should be higher than 0.7.
Composite Reliability	R	The composite reliability is a measure of internal consistency and must not be lower than 0.6.
Average Variance extracted	R	AVE measures the amount of variance captured by the construct relative to the amount of variance due to measurement error. Values should be higher than 0.5.
Fornell-Larcker Criterion	R	For ensuring discriminant validity of latent variables, AVE should be higher than squared correlations with all other latent variables.
Cross Loadings	R	Cross loadings offer another possibility for checking discriminant validity. If an indicator has a higher correlation with another latent variable, the appropriateness of the model should be reconsidered.

Notes: R: reflective

**Table 2 Proposed Quality Metrics for Structural Model**

Criterion	Structural Model quality metrics
R2	Chin 1998 described R2 values of 0.67, 0.33 and 0.19 for endogenous latent variables as substantial, moderate or weak.
Estimates for path coefficients	The estimated path regression weights should be evaluated in terms of sign, magnitude and significance.
Effect size f2	f2 can be viewed as an indicator whether a latent variable has a weak, medium or large effect at a structural level.
Stone Geisser-Criterion Q2	Q2-value is based on the blindfolding procedure: $\bar{Q}_2 = 1 - \left( \sum^D z z \varepsilon^D \right) \left( \sum^D z z \sigma^D \right)$ Q2 values should greater than 0.0.

While Cronbach's Alpha tends to provide a severe underestimation of the internal consistency reliability of latent variables in PLS path models, it is more appropriate to apply a different measure, the composite reliability (Werts et al., 1974). The composite reliability takes into account that indicators have different loadings, and can be interpreted in the same way as Cronbach's Alpha. No matter which particular reliability coefficient is used, an internal consistency reliability value above 0.7 in early stages of research and values above 0.8 or 0.9 in more advanced stages of research are regarded as satisfactory, whereas a value below 0.6 indicates a lack of reliability.

## 5. Discussion and Conclusion

In this paper we presented our experiences on using Partial Least Squares in usability research. In general, we show the mathematical process of the PLS-algorithm. Additionally we propose one possibility of developing manifest variables for latent usability attributes. Finally, we show extracted metrics for ensuring statistical quality of measurement and structural model. We confirm that PLS gives reliable results if the following requirements are fulfilled:

- Phenomena explored are new without existing construct and measuring theories
- Structural model includes a large number of indicating variables
- Research design focuses on relative small sample size
- Detection of causal paths and predictions is focused on

PLS is a powerful method of analysis because of the minimal demands on measurement scales, sample size, and residual distributions. Although PLS can be used for theory confirmation, it can also be used to suggest where relationships might or might not exist and to suggest propositions for later testing. As a result of our PLS-application we propose the following method for conducting a PLS-analysis in usability research:

- Theoretical deduction of Hypotheses based on causal relations
- Definition of manifest variables for measuring latent constructs
- Calculation of the PLS-Algorithm
- Quality assessment of structural and measurement model results
- Result interpretation

PLS is based on least squares estimation with the primary objective of maximizing the explanation of variance in a structural equation model's dependent constructs. Literature suggests that PLS is primarily intended for causal-predictive analysis in situations of high complexity but low theoretical information (Chin, 1998). The PLS-method does not require strong theory and can be used as a theory-building method (Gefen et al., 2000). Considering this, we conclude that this method is appropriate to calculating structural models in usability research due to incomplete theoretic background findings and missing unified empirical proved measurement scales by now. In our study, PLS led to first causal hypotheses testing in the usability domain. However, our results and first interpretations have to be tested and validated in future surveys focusing on similar topics.

## References

- Abran, A., Khelifi, A., Suryan, W. and Seffah, A. (2003) *Consolidating the ISO Usability Models*, Proceedings of 11th International Software Quality Management Conference Springer, Glasgow.
- Armstrong, B., Fogarty, G., Dingsdag, D. and Dimbley, J. (2005) *Validation of a user satisfaction questionnaire to measure IS success in Small Business*, Journal of Research and Practice in Information Technology, 37 (1), pp. 27-48.
- Bentler, P. M. and Chou, C. P. (1995) *Estimates and Tests in structural equation modeling*, In Structural equation modeling: concepts, issues and applications (Ed, Hoyle, H.) Sage, Newberry Park.
- Bevan, N. (1995) *Measuring usability as quality of use*, Software Quality Journal, 4 115-150.
- Bevan, N. and Macleod, M. (1994) *Usability Measurement in Context*, Behaviour and Information Technology, 13 (1), pp. 132-145.
- Chin, J., Diehl, V. and Norman, K. (1988) *Development of an instrument measuring user satisfaction of the human-computer interface*, Proceedings of the SIGCHI conference on Human factors in computing systems, 213-218.
- Chin, W. W. (1998) *Issues and Opinion on Structural Equation Modeling*, MIS Quarterly, 22 (1), pp. 7-16.
- Chin, W. W. and Lee, M. (2000) *A proposed model and measurement instrument for the formation of IS satisfaction: the case of end-user computing satisfaction*, International Conference on Information Systems (ICIS) Proceedings, Brisbane.
- Coursaris, C. and Kim, D. (2006) *A Qualitative Review of Empirical Mobile Usability Studies*, Proceedings of the Twelfth Americas Conference on Information Systems.
- Cronbach, L. J. (1951) *Coefficient alpha and the internal structure of tests*, Psychometrika, 16 (3), pp. 297-324.
- Duchowski, A. T. (2007) *Eye Tracking Methodology - Theory and Practice*, Springer, New York.
- Institute of Electrical and Electronics Engineers (IEEE) (1990) *Standard Glossary of Software Engineering Terminology*.
- Fornell, C. and Bookstein, F. (1982) *Two structural equation models: LISREL and PLS applied to Consumer Exit-Voice Theory*, Journal of Marketing Research, 19 (2), pp. 440-452.
- Gefen, D., Straub, D. W., and Boudreau, M.-C. (2000) *Structural equation modelling and regression: Guidelines for research practice*. Communications of the Association for Information Systems, 4(7), 1-78.
- Goldberg, J. and Kotval, X. (1999) *Computer interface evaluation using eye movements: methods and constructs* International Journal of Industrial Ergonomics, 24 (6), pp. 631-645.
- Gordon, I. E. (2004) *Theories of visual perception*, Psychology Press, Hove.

Grossman, T., Fitzmaurice, G. and Attar, R. (2009) *A survey of software learnability: metrics methodologies and guidelines*, Proceedings of the 27th international conference on Human factors in computing systems ACM, Boston, MA, USA, pp. 649-658.

Homburg, C. and Baumgartner, H. (1995) *Beurteilung von Kausalmodellen - Bestandsaufnahme und Anwendungsempfehlungen*, Marketing ZfP, 17 (3), pp. 162-176.

Homburg, C. and Giering, A. (2001) *Personal characteristics as moderators of the relationship between customer satisfaction and loyalty: An empirical analysis*, Psychology & Marketing, 18 (1), pp. 43-66.

Iilomäki, T. (2008) *The Usability of Music Theory Software: The Analysis of Twelve-Tone Music as a Case Study*, In Computer Music Modeling and Retrieval. Sense of Sounds: 4<sup>th</sup> International Symposium, CMMR 2007, Lecture Notes in Computer Science (LNCS)Springer-Verlag, pp. 98-109.

International Organization for Standardization (ISO) (1998) *Ergonomic Requirements for Office Work with visual Display Terminals (VDTs); Part 11: Guidance on Usability*, ISO 9421-11.

International Organization for Standardization (ISO) (2004) *Software Engineering - Product Quality; Parts 1-4*, ISO 9126.

International Organization for Standardization (ISO) (2006) *Ergonomics of Human-System-Interaction; Part 110: Dialogue Principles*, ISO 9241-110.

Kirakowski, J. and Corbett, M. (1993) *SUMI: The Software Usability Measurement Inventory*, British Journal of Educational Technology, 24 (1), pp. 210-212.

Nembhard, D. and Napassavong, O. (2002) *Task complexity effects on between-individual learning/forgetting variability*, International Journal of Industrial Ergonomics, 29 (2), pp. 297-306.

Nembhard, D. and Uzumeri, M. (2000) *Experimental learning and forgetting for manual and cognitive tasks*, International Journal of Industrial Ergonomics, 25 (2), pp. 315-326.

Olle, T. W., Sol, H. G. and Verijin-Stuart, A. A. (1986) *A comparative evaluation of system development methods*, Proc. of the IFIP WG 8.1 working conference on Information systems design methodologies: improving the practice North-Holland Publishing Co., Noordwijkerhout, Netherlands, pp. 19-54.

Rengger, R., Macleod, M., Bowden, R., Blaney, M. and Bevan, N. (1993) *MUSiC Performance Measurement Handbook*, National Physical Laboratory, Teddington, UK.

Schalles, C., Creagh, J. and Rebstock, M. (2011) *Usability of Modelling Languages for Model Interpretation: An Empirical Research Report*, to be published at 10. internationale Tagung Wirtschaftsinformatik (WI2011), Zürich.

Schalles, C., Rebstock, M. and Creagh, J. (2010a) *Developing a Usability Evaluation Framework (FUEML) for Modeling Languages*, Proceedings of the IASTED International Conference on Software Engineering (SE) (Eds, Fox, R. and Golubski, W.) Acta Press, Innsbruck, pp. 126-135.



- Schalles, C., Rebstock, M. and Creagh, J. (2010b) *Ein generischer Ansatz zur Messung der Benutzerfreundlichkeit von Modellierungssprachen*, Modellierung 2010, Vol. 161 (Eds, Engels, G., Karagiannis, D. and Mayr, H. C.) Gesellschaft für Informatik (GI), Klagenfurt, pp. 15-30.
- Seffah, A., Donyaee, M., Kline, R. and Padda, H. (2006) *Usability measurement and metrics: A consolidated model*, Software Quality Control 14 (2), pp. 159-178.
- Tamir, D., Komogortsev, O. V. and Mueller, C. J. (2008) *An effort and time based measure of usability*, Proceedings of the 6th international workshop on Software qualityACM, Leipzig, Germany.
- Tenenhaus, M., Vinzi, V. E., Chatelin, Y. M. and Lauro, C. (2005) *PLS Path modeling*, Computational statistics & Data analysis, 48 (2), pp. 159-205.
- Vuolle, M., Aula, A., Kulju, M. and Vainio, T. (2008) *Identifying Usability and Productivity Dimensions for Measuring the Success of Mobile Business Services*, Advances in Human-Computer Interaction.
- Werts, C. E., Linn, R. L. and Jöreskog, K. G. (1974) *Intraclass reliability estimates: Testing structural assumptions*, Educational and Psychological Measurement, 34 (1), pp. 25-33.
- Wold, H. (1980) *Model construction and evaluation when theoretical knowledge is scarce: theory and application of partial least squares*, In Evaluation of econometric models (Eds, Kmenta, J. and Ramsey, J. B.) Academic Press, New York.



# **Organisational Culture: The Impact on the Merger and Acquisition Process**

**Sheila Lewis, Dr Angela Wright.**

**sheilalewis@eircom.net  
angela.wright@cit.ie**

## **Abstract**

As the number of mergers and acquisitions is rapidly increasing and incredible growth is being encountered globally in the merger and acquisition arena, this paper focuses on the affect of organisational culture on the merger and acquisition process. This paper identifies what lessons can be learned that could improve the chance of success in future merger and acquisition activity. This paper affirms that organisational culture has a dramatic effect on the success of a merger or acquisition. Undetected cultural issues at the outset of any merger or acquisition can culminate in culture clashes post acquisition which can result in the ultimate failure of the merger or acquisition. This study highlights the pivotal role of management in managing the culture within an organisation. Communication across all levels of the acquiring and acquired company is another factor which is of paramount significance for the success of any merger or acquisition. This paper explores the facets

## **Keywords**

Culture Integration, Organisational Culture, Merger and Acquisition process.

## **Introduction to the Topic**

The topic of this research paper Organisational Culture, The Impact on the Merger and Acquisition Process explores the affect organisation culture has on the Merger and Acquisition process. Many companies are undertaking mergers or acquisitions as a means of growth. All companies undertake a financial due diligence of the prospective target company but many fail to realise where the main integration problems can lie. The researcher believes it is important that these companies take cognises of the affect which organisational culture can have on the integration of the merger and acquisition and can ultimately be responsible for its success or failure. The culture within a company is formed by its people, they are the human capital within the organisation. Through her employment as an accountant the researcher took an interest in this area and affirmed it would be worthy of research.

## Introduction

*However automated and capital-intensive manufacturing and service industries become, whatever the developments in robotics and information systems, one will never be able to neglect the importance of people (Dawson, 1986: 3).*

It is almost a cliché to say that a company's most valued asset is its' people. The culture within an organisation stems from its' people. There are many views relating to organisational culture and also many definitions of organisational or corporate culture and while they vary, in general, they focus around the fact that it pertains to the values, beliefs and norms within an organisation. Organisational culture is a key driver in terms of how a company works and if all levels of a business do not work in a cohesive manner, the resulting affect can be detrimental to the organisation.

In assessing a potential target merger or acquisition, it is imperative that the acquiring company looks at the 'people element' within the company. The selection of companies with mismatches of organisational culture or, where corporate cultures collide, results in further problems in integrating and in the loss of valuable growth and profitability for the company. While merger and acquisition activity was once conducted with little regard to the human consequences, this blinkered strategic approach is no longer tenable (Brown, 1995: 179). "Those organisations that have cultures which fit the environment and the business strategy will perform well relative to those companies whose fit is poor" (Brown, 1995: 187). The 'fit' element cannot be ignored in a merger or acquisition as ultimately, a target which does not fit with the core business ethos of the existing company will not be integrated in a smooth and cohesive approach.

With the majority of companies undertaking mergers and acquisitions as a means of organic growth, the realisation of attainable synergies and economies of scale is dependent upon the performance achieved by the combined company. There are occasions when an increase is experienced in the magnitude of mergers and acquisitions. According to Samuels (1994) one of the most commonly cited theories is that mergers and acquisitions are associated with booms and slumps in the economy and a drop in stock market prices. Mergers and acquisitions have previously failed as a direct consequence of the slowdown in the economy in 1903 and the stock market crashes of 1929 and 2000. Today's demanding financial environment will put immense pressure on companies to succeed. The current turbulent economic times of recession will further challenge acquirers to increase profit maximising and value creating synergies while ensuring faster cost-reduction initiatives are implemented post integration.

## **Research Methodology**

The experiential constituent of this research was completed using a qualitative research methodology. The approach adopted in selecting the interview participants in this study was based on convenience sampling. The Interview pool selected by the researcher consisted of eleven people accessed directly at senior executive, director or management level in companies which had undergone mergers and acquisitions. Those interviewed averaged twenty plus year's business experience therefore allowing them to discuss this subject with confidence. The respondent companies comprised a mix of international, indigenous and family owned companies. This research provides a clear and informed insight into the affect of organisational culture. Interviews were the chosen method of research. Alternative research methods were examined and their suitability assessed but they were deemed by the researcher not to be appropriate for this study due to the confidential and sensitive nature of the topic being discussed and the professional capacity of the interviewees selected. The qualitative research data was analysed using the grounded theory procedure for data analysis. The research instrument had benefited from two pilot interviews which were specifically chosen for pilot testing, these were carried out prior to the main interviews and were not included in the main body of the study

## **Organisational Culture in Business**

This study reports that culture is often viewed as a soft issue that few people understand, it is seen as something abstract and intangible in an organisation. The professionals interviewed in this study believe that organisational culture is probably the most critical area of any company, and that to deliver on your business model the culture must be right. There can be many different cultures within any one organisation and also specific cultures can be associated with particular business sectors.

This study suggests that culture is bred into an organisation through its management with it being possible to sense a culture almost immediately when you enter an organisation. It is seen as explaining the dynamic across various sites and reflecting the ethos of the whole organisation. Viewed as a primary driver of internal behaviour within a company, this study observes that culture begins at the recruitment stage in any company where it is ascertained if the new employee will "fit" into the culture of the company.

This study establishes that the importance of management is recognised to a greater extent in that the management and leadership within a company can transform its business processes and play a significant role in how culture is managed within an organisation. One of the participants in this research states that one of the primary responsibilities of a leader is to have a vision of the culture of their organisation, and then to think about how they are going to imbue that culture in the organisation. A finding arising from this study is that managers need to be equipped with the right leadership skills and experience to be able to focus on their core competencies and

maximise efficiencies in their organisation, as it is the role of the leader to permeate the correct culture within the organisation. All participants in this study agreed that a change in management can have a dramatic effect on the culture within a company.

This research study affirms that communication is of paramount importance in the integration process of a merger or acquisition and ensures everyone understands what the organisation is striving to achieve. Participants of this study believe that communication will have a massive impact on a business because if people do not know what is happening, it creates a very strange environment. Further analysis of this research reveals that local management and long-standing employees are seen to play a significant role in the communication of culture within an organisation. One factor which was seen as being an important element pertaining to culture in mergers and acquisitions is the ability to plan and effectively communicate that plan, to being able to engage people and harness their ability to actually move the business forward, and create a shared vision for the joint organisation.

## **Correlation between Internal Organisational Culture and Mergers and Acquisitions**

Recklies (2001) expresses that it is a widely recognised fact that cultural differences between the partners of a merger or acquisition are one of the most common reasons for failure. This research study concurs with the findings of Recklies (2001) who believes there is a clear correlation between internal organisational culture and mergers and acquisitions. Eight of the interviewees in this study believe that there is a distinct correlation between the internal organisational culture and mergers and acquisitions. This research indicates that you must understand your own culture very clearly and then understand what characteristics you perceive to be important of those working in the company before you will understand the culture of your target organisation.

This study highlights the importance of many factors in affecting the correlation between internal organisational culture and mergers and acquisitions. In addition to a change in size of the organisation, the business environment, competitors, leadership, the financial strength and group expectations for the company are also seen as having a major influence on the organisational culture and success of the company. Many researchers insist that the culture of the target company needs to be compatible with or 'fit' the culture of the acquiring company if the merger or acquisition process is to be successful. This study supports this and also states that if a prospective target company is seen to have a totally counter culture to what the group espoused then a merger or acquisition would not be an option. This research also uncovers that the types of culture prevalent in the target company can also determine if the culture will be cohesive with the culture of the acquiring company.

## **Target Selection and Cultural Due Diligence**

The participants of this study suggest that a clearly defined integration plan and achieving synergies are critical in the target selection process. Half of those interviewed in this study believe that an increasing number of companies are focusing a lot of time and resources on the financial and technological systems due diligence with no real thought being allocated to the corporate culture of the organisation. Recognising the confidential process of the due diligence, the interviewees in this research believe that a 'cultural due diligence' would add immensely to the process. The interviewees acknowledge that the 'cultural due diligence' however, would be best carried out in an informal manner so as to acquire a better picture of the organisational culture.

## **Factors affecting the Merger and Acquisition Integration Process**

Duncan (2008) identifies other contiguous factors such as slowdown in the economy, stock-market collapse, lack of finance and environmental factors, as factors which can affect the integration process of a merger or acquisition. This research agrees that there are various factors such as lack of communication, inadequate management and organisational crisis which affect the merger and acquisition integration process. Concurring with the literature of Duncan (2008) this study confirms that a financial crisis can have a dramatic affect on the organisation and its culture.

This research confirms that throughout the integration process of the merger or acquisition it is important that a company does not lose sight of their long-term objectives. It is critical that any obstacles encountered in the merger and acquisition process are resolved as this will ensure that the task of integration is simplified with the long term benefits becoming more attainable. This study can affirm that it is important to ensure that all the goals set by the acquiring company for the integration process are achievable, within the designated time frame, and that sufficient resources are put in place to facilitate this and to avoid problems in the future.

## **Changing Organisational Culture**

This research suggests that while it is possible to change organisational culture post acquisition, it will require a lot of time to do this, and change must be initiated from management level. Implementing change management in any organisation can easily become obstructed by dealing with more urgent issues such as attaining productivity levels and strategic development. With the right approach, a potentially complex change project can be simplified to drive efficiency in the company and result in a smooth integration process. This research study confirms that organisational change needs to be implemented in a coordinated, structured and efficient manner. It can be difficult to execute, with resistance from operational teams likely, but everything depends on the change management policy adopted by

the organisation. According to the participants in this study various operational changes happen constantly in business, but they all agree that it is important that they are approached in a way that does not affect the people within the organisation.

## **Managing the Human Capital**

This research has found that managing the human capital within the newly acquired company after the merger and acquisition plays a significant role in the management of the integration process. The selection of key management in the newly acquired company was seen as an important development in the transition to become part of the new group structure. One of the directors in this study commented that there is a weakness in most companies if they do not elect a champion in the existing business who is going to be the interface, the 'eyes and ears' helping both senior and middle management in the target company to make their transition. Uncertainty and change within the business would have a significant affect on the employees as part of the merger and acquisition process. The participants in this research concur that consideration needs to be given to the fears and anxieties of employees who will resist the change within the integration process.

## **Merger and Acquisition Success or Failure**

Timms (2007) states that successful mergers and acquisitions are not just about financial data, but are also about people and cultures. Timms (2007) also states that successful mergers and acquisitions are about strategically seeking potential suitors and making the process as transparent and simple as possible. This research has found that organisational culture is directly responsible for failed acquisitions due to the culture within the acquired company not being cohesive with that of the acquiring company. The participants in this study view the influence of culture as pertaining to the whole ethos of the company, while one interviewee states that you can almost sense a culture when you walk into an organisation. Eight of the interviewees in this study believe that there is a definitive link between the internal organisational culture and mergers and acquisitions and they also confirm that ignoring the prevailing culture in an organisation could result in unfavourable consequences for the merger or acquisition. A finding worthy of note in this research is that while organisational culture is predominately seen as a key factor in the failure of mergers and acquisitions it is the least expensive causal factor to correct.

Cultural fit was reported by seven of the interviewees in this research as being of paramount importance if the merger or acquisition is to be a success. A finding emerging from this research is that poor and inadequate integration of the merger or acquisition is seen as being damaging to the outcome of a merger or acquisition. A finding worthy of note in this research is the importance of acknowledging successful business strategies within the acquired company and capitalising on these for the benefit of the joint company going forward. Many of the professionals interviewed mentioned the importance of culture which has a major influence on



how a company delivers on its business model. This study outlines that having the correct culture and understanding it fully is an essential ground tool for a successful merger and acquisition.

## **Culture versus other Acquisition Factors**

This research has found that culture is the most important factor to be considered as part of the merger and acquisition process. The participants in this study believe that if you want to use the company as a platform for real growth and real development, you must have positive culture, because positive culture will lead to the development of a very strong team. Some of those interviewed in this study believe that culture may be close to the financial data in terms of importance but information technology and other factors were definitely seen as having a much lesser importance than both in the merger and acquisition process. One interviewee in this research acknowledges that the acquisition of high quality people in essence is an asset you get for free. Other interviewees commented that the impact of the merger or acquisition on market share and future sales needs to be considered.

## **Strategic Objectives and Organisational Performance**

This research reveals that attaining the strategic objectives and increasing organisational performance is the main focus of all businesses. Ten of the interviewees in this research believe that putting an emphasis on culture most definitely would allow a company to achieve its strategic objectives, and improve organisational performance. One interviewee in this study confirms that an organisation is the sum of its parts. An interesting dimension arising from this study is the fact that culture isn't measured by an organisation therefore making it difficult to assess the true impact. One of the interviewees in this research recommended that Kaplan and Norton's Balanced Scorecard should be used more by companies as it can measure not just the financials but also other perspectives and that culture could be measured in this manner. This study has also found that where an organisation has an understanding of the culture which operates within its business, that in itself, will go a long way towards managing performance. Another finding emerging from this study is that the type of culture prevalent in an organisation will influence the affect culture will have on the organisational performance, an organisation with a culture of cost consciousness for example, will obviously be more focused on realising profit.

This study reports that culture can motivate or de-motivate individuals which in turn will impact on the organisational performance. Another finding emerging from this research is that a company who adopts the right culture for the business in which they operate is more likely to have successful people at all levels which in turn will have a huge impact on the expected longevity of that organisation and the profit realised. One interviewee muses: "Using a rugby analogy – making the hard yards,

companies who have the right culture make the hard yards more effectively, they implement the spirit and the detail of the business model and are more likely to have champions at all levels, I would say it has a huge impact on short term performance and it certainly has a huge impact on the expected longevity of that organisation and the bottom line”.

## Conclusions

Tracing back through history, mergers and acquisitions have evolved greatly since the first merger in 1897, the increasing pace of change in the business world demands a more flexible approach since then. Mergers and acquisitions appear to be triggered by economic factors. The macroeconomic environment plays a key role for example in designing the process of mergers or acquisitions between companies or organisations.

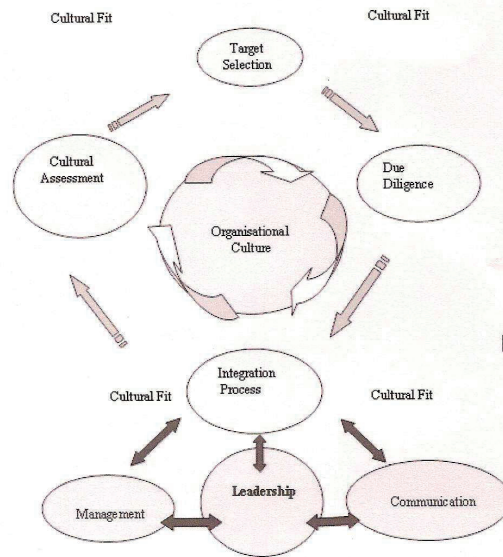
Synthesis of the knowledge collected from this research has enabled the generation of a number of key conclusions. These conclusions are diagrammatically presented in Figure 1. This research demonstrates and concludes that the elements of management, leadership and communication are fundamental to a successful merger or acquisition integration process. Together with a clearly defined integration plan for target selection and a well defined cultural assessment and due diligence an organisation can establish a framework with which to ensure that organisational cultures “fit” cohesively.

### Key Conclusions

This study provides enlightening insights into mergers and acquisitions, and the affect of culture on these mergers and acquisitions. This study can conclusively state that culture is the key driver of behaviour in the majority of organisations and has a dramatic effect on the success of a merger or acquisition. When an organisation embarks on a merger or acquisition, they should ensure that they understand the culture that lies within the target company selected for merger or acquisition, as too often, cultural differences arise which result in the ultimate failure of the merger or acquisition. This research has found that very often, these differences in organisational culture could have been avoided if an informal ‘cultural due diligence’ had been carried out at the outset. This informal due diligence would significantly reduce the risk of acquiring a company where differing cultures could eventually collide. The primary conclusions from this study confirm that senior executives in business consider a “cultural due diligence” as being a worthwhile undertaking for any company involved in the merger and acquisition process.

This research highlights the pivotal importance of managing the human capital as part of the integration process. The people or human capital in any organisation has the unique ability to conquer or destroy any culture integration plans within an organisation. The findings from this current study suggest that for a merger or acquisition to be successful it is essential that it is managed by a committed

management team who will encourage group activities and projects bringing the team together and alleviating any apprehension and fear of the unknown. It is vital that the management team within an organisation appreciate the affect that organisational culture has on the business, and that they imbue a solid grounded culture as this culture will permeate through the organisation and is essential for organisational success. Leadership and communication play a pivotal role in managing the fears and anxieties of employees, making the effort early on in the integration process of the two companies, is seen as being paramount to bringing the new team on board as well as considering the anxieties of the existing team. In companies where the importance of the human capital factor is embraced, significant benefits accrue resulting in an ultimate increase in organisational performance and the ability to realise the strategic objectives of the company.



**Figure 1: A Successful Merger or Acquisition Integration process.**

At the time this research study was completed in 2009, Ireland was in the midst of a recession which was resulting in the closure of many businesses and transfer of manufacturing processes to countries with a cheaper cost base, and therefore, the loss of many jobs nationwide. This economic situation was also affecting other countries as a result of the difficulties due to the global credit crunch. This current research study found that the economic slowdown and financial crisis can result directly in the failure of mergers and acquisitions. The interviewees in this research did not cite this directly, but rather the effect of the crisis on the culture which would affect the success of the merger or acquisition. The author of this research believes that it could yield interesting insights to revisit this when Ireland emerges from the

recession to investigate if the economic factors did have an affect on mergers and acquisitions during the recession.

## References

- Brown, A. (1995). *Organisational Culture*, Pitman Publishing, p. 183.
- Dawson, S. (1986). “Analysing Organisations”, *MacMillan Education*. p. 3.
- Duncan, Wm. (2008). “Ten Important Lessons From the History of Mergers & Acquisitions” <http://ezinearticles.com/?Ten-Important-Lessons-From-the-History-of-Mergers-and-Acquisitions>, accessed 8th September 2009.
- Griffin, R.W. (1999). *Management*, Sixth Edition, Houghton Mifflin.
- Handy, C, B. (1993). *Understanding Organizations*. Fourth Edition. Penguin.
- Hill, C.W.L. (2008). *Global Business Today*, Fifth Edition. Mc Graw-Hill. International Edition.
- Lynch, J.G., and Lind, B. (2002). “Escaping merger and acquisition madness”, *Strategy & Leadership*, vol. 30, no. 2, pp. 5-12.
- Mc Clave, H, J. (1986) *Communication for Business in Ireland*. Gill and Macmillan.
- Peters, T.J, and Waterman, R.H. (1986) “In Search of Excellence (lessons from America’s Best-Run companies)”, Harper & Row Publishers. pp. 75-76.
- Recklies, O. (2001). “Mergers and Corporate Culture”. *Recklies Management Project GmbH*. [www.themanager.org](http://www.themanager.org). Accessed 01 August 2009.
- Samuels, J.M., Wilkes, F.M, and Brayshaw, R.E. (1994). “*Management of Company Finance*”, Fifth Edition, Chapman and Hall. p. 611.
- Timms, P. (2007). “Avoid the M&A Trap”, *Excellence in Leadership*, CIMA, Issue 3, 2007, p. 26.

# The Growth of E-Procurement in Ireland: How the Private and Public Sectors are Adapting to Purchasing On-line.

James Barrett & Dr. Angela Wright

Cork Institute of Technology, Cork, Ireland.  
e-mail: [jim@c-cad.com](mailto:jim@c-cad.com) and [angela.wright@cit.ie](mailto:angela.wright@cit.ie)

## Abstract

This current study is an examination of the growing trend of electronic procurement (e-procurement), and how the Irish private sector and public sector are evolving to purchase goods and services over the Internet. With any new technology, it takes time for standards to emerge and common practices to be adhered to. This research investigates a cross-section of Irish companies and organisations to determine where and how they are using e-procurement and if standard trends are developing. This study also examines current practices in relation to traditional procurement, to determine if there is scope to transition some of these practices over to e-procurement. A significant finding of this research is that traditional purchasing methods are still predominantly used for most business to business (B2B) and business to government (B2G) purchasing transactions. E-procurement occupies a secondary role for non-critical low value fast moving purchases and once-off items. Another significant finding of this study is that e-procurement is not suitable for purchasing raw materials, critical stock items, capital equipment, complex items, or situations where negotiations are required.

## Keywords

E-procurement, E-business, E-commerce, Public & Private Sector, SMEs, MNCs.

## 1. Introduction

The Internet is a significant enabler for B2B and B2G trade on a global scale. Businesses can find new sources of supply, quicker and easier than ever before. Suppliers too can use the Internet to reach new customers at an unprecedented level. Hsiao (2009) notes that in the past decade, the way people shop has changed dramatically with the aid of information and communication technologies (ICT). As well as shopping at physical stores, consumers are able to shop via the Internet. People are comfortable booking and paying for flights, trains and hotels on-line, while businesses are purchasing from on-line catalogues and on-line stores with apparent similar ease, introducing new efficiencies and automation. According to Wang and Lin (2009), electronic commerce (e-commerce) has substantially affected the business world and is expected to increase in importance.

## 2. Research Methodology

Primary research was carried out by interviewing decision makers from twelve organisations from the private and public sectors in Ireland. This included owners, directors or senior managers from small and medium enterprises (SMEs) and the purchasing managers or senior purchasing representatives from larger organisations. A qualitative, mono method research approach with semi-structured/non-standardised interviews was adopted. The purpose of this research is to ascertain how Irish companies and organisations are adapting to purchasing on-line and for what types of goods and services. It is also to establish recommendations regarding the implementation of strategies for purchasing on-line. The authors, for the purpose of this current research, will discuss e-procurement in terms of completing purchasing activities in their entirety over the Internet, facilitated by on-line market stores and market sites, or through on-line auctions or exchanges.

## 3. Literature Review

Hutt and Speh (2004) argue that the Internet does not replace existing channels of distribution, but it supports and supplements them. Afuah and Tucci (2003) previously argued that the Internet is a technology that has the potential to transform the competitive landscape for numerous industries, while also creating whole new industries. Phillips (2003) notes that, until recently, businesses have been able to use the same basic model to compete in the marketplace since the industrial revolution, but the Internet is a prime example of a disruptive technology for organisations and industry sectors. Jelassi and Enders (2008) concur and further state that, business models have appeared which would have been unthinkable before, for example eBay, Google and Amazon have disruptively stirred up the market like no other. Jelassi and Enders (2008) compare the evolution of electronic business (e-business) to the life cycle of other technological revolutions, for example, the printing press, steam engine, railway and car. Sharma (2002) previously noted that if businesses do not adapt to e-commerce, value may migrate from them and they will become obsolete, similar to how value migrated from small-lot manufacturing of automobiles toward mass-produced Ford automobiles in the early part of the twentieth century. Tuttle (2003) notes that, industrial buyers are insisting on more automated choices from big and small suppliers. "Distributors must make a choice: either join the fray in e-commerce or, expect to eventually become obsolete" (Tuttle 2003, p. 55).

Turban *et al.* (2006) state that the main driver of e-commerce is the digital revolution, with the Internet at its centre. According to Preston and Cawley (2008), national governments and the European Commission have pushed 'broadband' to the fore of social and economic policies, aligning its development with furthering the information society and knowledge economy. Taylor *et al.* (2004) previously stated that the United Kingdom and other governments have noted that the SME sector has been slow to adopt e-commerce. This view is supported by Batenburg (2007), who found that large firms use e-procurement much more than SMEs, and firms within the ICT, electronics and manufacturing industries show much higher rates of adoption. Awad (2004) previously noted that replacing a purchasing bureaucracy

with on-line links means savings, improved efficiency, fewer errors, and a just-in-time environment that reduces inventory sitting in a warehouse. Laudon and Traver (2007) highlight further benefits including; universal standards, which greatly lowers 'market entry costs' and reduces 'search costs' for buyers, and 'price discovery' becomes simpler, faster and more accurate. E-commerce makes it possible, for the first time in history, to find many of the suppliers, prices and delivery terms of a specific product anywhere in the world (Laudon and Traver, 2007).

#### 4. Findings

The findings of this current research have shown that:

- Traditional procurement methods are being used for the majority of B2B and B2G purchases with on-line purchasing being used in a secondary role for non-critical low value fast moving items or for once-off low value purchases.
- Ten out of the twelve respondents claim that their purchasing spend done on-line is less than ten percent and six out of the twelve claim it is one percent or under.
- Large manufacturing multinational companies (MNCs) commonly use vendor-managed inventories (VMIs) to manage stock levels for critical stock items rather than purchasing them on-line.
- Some large manufacturing MNCs still use post and fax to send orders.
- Public sector organisations have to advertise for their requirements on electronic tendering (e-tendering) Web sites. Orders are then processed to the successful companies using traditional purchasing methods or on-line catalogues.
- SMEs involved in ICT may be more likely to use e-procurement than SMEs involved in other industries.
- Security is important when making purchases on-line. A familiar name or brand is important in selecting an on-line supplier.
- Some companies use a secure log in to a supplier's Web site, and they have a credit account, eliminating the need for credit card payments.
- Companies need to work more efficiently because staff numbers are reduced.
- Companies have achieved improved efficiencies by purchasing on-line.
- Transaction costs for orders on-line are significantly cheaper than through traditional procurement.
- Some companies find it an advantage to be able to purchase on-line at any time.
- The large choice of suppliers available on the Internet is an advantage to some respondents and a disadvantage to others.
- The lack of integration between suppliers' e-procurement systems and their customers' transaction management systems is one of the principal barriers to more widespread adoption of e-procurement.
- If integration of suppliers' e-procurement Web sites with their customers' enterprise resource planning (ERP) systems is to take place, consideration will need to be made for the fact that many large MNCs, particularly in the pharmaceutical industry, forbid external access to their internal systems.
- Some organisations need to physically see what they are buying, particularly for complex purchases.

- Companies need specialised consultancy and advice for complex purchases.
- U.S. firms need to comply with Sarbanes-Oxley regulations, requiring a strict approval process for POs (purchase orders). This is a barrier to buying on-line.
- Companies must avoid the risk of running out of stock for critical items used in production. Because suppliers' e-procurement systems and buyers' ERP systems are not integrated, this is a barrier for purchasing raw materials on-line.
- E-auctions, also known as reverse auctions, are very expensive and some companies find the cost prohibitive.
- Inability to negotiate on-line is a barrier to implementing e-procurement.
- Organisations would consider purchasing more on-line if suppliers provided them with a credit account.
- On-line purchasing systems are not available from many suppliers.
- Some companies find it more efficient to send orders to suppliers via e-mail, rather than purchasing on-line from suppliers' catalogues.
- Barriers to e-procurement are being challenged at corporate level in the private and public sectors. Some MNCs are promoting more use of the reverse auction.

## 5. Justifications and Recommendations

### 5.1. Current Procurement Practices of Irish Organisations

A significant finding emerging from this research reveals that traditional procurement methods continue to be used for the majority of purchasing by most of the organisations that took part in this study, with e-procurement being used in a secondary role for non-critical low value fast moving items or for once-off low value purchases. One participant states, "We see the use of on-line purchasing for the low value, nuisance value stuff." Ten out of the twelve respondents claim that the percentage of their purchasing spend that is through e-procurement is less than ten percent and six out of the twelve claim that it is one percent or under. Another respondent suggests, "There's lip service to e-procurement, saying we use it, but people don't. If you take big companies in Ireland, nobody has embraced the whole model. People have been talking about it and it's not moving."

The findings of this research have shown that large MNCs continue to use traditional procurement as their main method of purchasing. One respondent states, "We do very little of it on-line. We would buy office stationery on-line, but it's to a very small degree." On-line catalogues are used to order low value high volume items. As one participant notes, "We use on-line catalogues for some of our consumable items, particularly stationery, lab-consumables, protective gear; low value high volume items." Traditional procurement is still the most popular method of purchasing raw materials. One respondent states, "Raw materials are purchased using traditional methods." Large manufacturing MNCs commonly use VMIs to manage the stock level of critical stock items. One participant notes, "They would be in here maybe three times a week looking at the different containers of screws and washers, making sure that we are stocked to our maximum quantity. It's purely a manual system."



An important finding of this research reveals that while e-mail is very often used to send orders to suppliers, some MNCs still use post and fax. One participant notes, "The PO is raised on our system. In some instances it's either faxed directly from the system or e-mailed. In other instances it's printed and posted."

Public sector organisations have to advertise for their requirements on e-tendering Web sites; the Irish e-tenders Web site or the European EU-journal. Orders are then processed to the successful companies using traditional purchasing methods or on-line catalogues. One participant states, "We have a procurement policy, that once you go over a certain threshold you have to advertise it on the e-tenders Web site." Public sector organisations also use on-line catalogues for some of their on-line purchases, with companies that have been successful with their e-tender application. One participant notes, "We have a contract where we get our stationery through the advantage of bulk buying through an on-line catalogue." Public sector organisations also purchase once-off purchases on-line. One respondent states, "All our travel, hotels and once-off parts for research are purchased on-line."

This current research has found that many SMEs still do most of their purchasing using traditional procurement methods. One participant states, "We purchase very few products on-line. We would purchase flights, trains, hotel accommodation." The findings of this research have shown that SMEs involved in ICT may be more likely to use e-procurement than SMEs from other industries. One participant states, "About seventy percent of our purchasing is done on-line. I'm happy to do it. We all know how purchasing on the Internet has revolutionised the travel industry and, it's second nature to anyone in the information technology industry."

## **5.2. Attitudes towards Security and Trust with E-Procurement Transactions**

This current research has found that organisations consider security to be important when buying on-line. One participant states, "Any time we get into a contract with a company, we vet them." This current study has found that public sector organisations also have a cautious approach. One respondent suggests, "It would only work for specific sites that have been pre-approved." This study has found that SMEs need to be happy that they are dealing with a legitimate Web site. One participant notes, "Any Web site that you're putting credit card details into, you want to be sure it's bona-fide, and generally those purchases would be with established, known businesses." Most respondents acknowledge that a familiar name or brand would be important in selecting an on-line supplier. One participant notes, "We wouldn't be buying from unknown companies. They would be trustworthy names." Another interesting finding from this research is that some companies use a secure log in to a supplier's Web site, with a credit account, eliminating the need for credit card payments. As one participant states, "We have a secure log in and password to their ordering system. The invoice is electronic, so I have no concerns with that."

## **5.3. Advantages of E-Procurement**

The findings of this current research show that companies have achieved improved efficiencies by purchasing on-line. One participant notes, "Even the small prototype

we have in office supplies is very efficient. If we look at our current process; creating a request, getting a quotation, getting approval on SAP (Systems Applications and Products), getting a purchase order approved, sending it out to the vendor, and getting the invoice, compared to ordering on-line and getting it tomorrow. There are huge efficiencies in this.” Another respondent states, “While putting catalogues in place, you are freeing up time for more strategic procurement.”

An important finding emerging from this research is that companies need to work more efficiently because staff numbers have been reduced. One participant notes, “We have reduced our purchasing staff by fifty percent in the last two years. With less people and more to do, we have to use technology to help, especially for these nuisance value items.” Transaction costs for orders on-line are significantly cheaper than traditional procurement. One participant notes, “The whole cost of a traditional purchase order is between seventy and a hundred euro, compared to cents for electronic transactions.” It is an advantage to some Irish companies to be able to make on-line purchases at any time. One respondent suggests, “The main value to business with e-procurement is efficiency and availability. With twenty four hours available, you are not relying on a person being on the end of a phone.”

This current study has found that the large choice of suppliers available on the Internet is an advantage to some respondents and a disadvantage to others. One participant notes, “The choice is there and you can make a judgment call on who you want to buy from.” While another participant from a SME notes, “You may find it difficult to find suppliers, because you end up with a huge number of claimed suppliers, and you narrow it down to the ones that can deliver what you want, and then you have to examine the details of the products. That type of on-line procurement is very time consuming.” Another respondent from a MNC states, “Having a bigger choice won’t be a benefit to us, because we can’t deal with somebody who’s not approved.” While other large MNCs see the extra choice as an advantage so that they can source additional suppliers for their tender lists. As another participant suggests, “If we are asked to go to tender, we would go on-line and see what’s out there. And, if we think we have found a potentially good supplier from the Internet, we would contact them, and ask them to present a business case.”

#### **5.4. Barriers to E-Procurement Adoption**

A significant finding emerging from this study is that the lack of integration between suppliers’ e-procurement systems and their customers’ transaction management systems is one of the principal barriers to more widespread adoption of e-procurement. One participant notes, “The main barrier is that you have a SAP system that’s stand alone. You still have to create the purchase order first. Then you have to key it into the supplier’s Web site and process it, so you’re entering the order twice.” If this integration is to happen, consideration will need to be made for the fact that many large MNCs, particularly in the pharmaceutical industry, forbid external access to their internal systems. As one respondent notes, “We have significant security issues on site, where we won’t allow anybody externally to look at our system. We have another challenge in that; we currently fax all our purchase

orders to the vendors. Our rules will not allow us to send them by e-mail, because it opens up our SAP system to an unknown e-mail recipient.”

This current research has found that some organisations need to physically see what they are buying, particularly for complex purchases. One respondent suggests, “I don’t think that it can all be done on-line, because how do you get to sample the product, to see the product?” Companies also need specialised consultancy for some of the more complex purchases. As one participant states, “If you’re buying anything like vessels, reactors, cartridge filters, you can’t, because you have to get quotes, develop them with the vendor, change sizes, take the capacity of them into account, etc. You can’t go ahead and buy on-line for most of what we want to do.”

The findings of this research have shown that a barrier for the public sector to purchasing on-line, is government legislation that requires them to use the tendering process. One participant notes, “I can’t log onto Viking or someone and get them to send it on. Our organisation, like every other public authority, is required by legislation to advertise EU wide, when we spend above a certain threshold.” Also U.S. companies need to comply with Sarbanes-Oxley regulations, which require a strict approval process for POs. As one participant notes, “They don’t order them on-line. We still have to go through our ordering system, because we need control on all purchase requests. What drives that is the Sarbanes-Oxley requirement.” Another respondent suggests, “If we’re looking at the profile of our spending, we want to see exactly who we are spending our money with, how much we spend and what we’re spending it on. With on-line procurement, because it’s independent to our SAP system you lose traceability, so it’ll always be for incidentals only.”

Another important finding emerging from this study is that companies must avoid the risk of running out of stock for critical items used in production. Because suppliers’ and buyers’ systems are not integrated, this is a barrier for purchasing raw materials on-line. One participant states, “Raw materials will never be purchased on-line, because of the challenge of keeping them replenished.” This study has shown that one typical e-procurement method, the e-auction, or reverse auction, is very expensive and some companies find the cost prohibitive. One respondent notes, “We’ve done one in Ireland in the last ten years as a group. We won’t be doing another one fairly soon. It is expensive to set up. There is a seventy five thousand euro fee. You need to have a base spend of a million, just to cover your costs.”

This current research has found that the inability to negotiate on-line is a barrier to implementing e-procurement. As one participant suggests, “For purchasing on-line, the biggest barrier would be negotiating a price.” Organisations would also consider purchasing more on-line if suppliers provided them with credit. One participant states, “If companies were prepared to give us normal credit terms, we would certainly buy more on-line.” This current study has found that another barrier to purchasing on-line is that e-procurement is not available from many suppliers. One respondent suggests, “You’re tending to deal with a lot of old technology suppliers, heavy engineering. Many of them have barely got a home page or a Web site.” The findings of this research show that some companies would prefer to continue to send their order to their supplier by e-mail, rather than having to go through the supplier’s

catalogue to select the items and add them to the shopping basket. One participant notes, “The ability of our system to develop a purchase order and send it directly by e-mail is far more efficient than trying to purchase on-line. It’s like sending an e-mail to Tesco with our shopping list for the week, without having to go into the store, be it a virtual store or a real store, and try and find all the products in the store.”

### **5.5. Predicted Development of E-Procurement in Irish Organisations**

This current study has found that Irish companies consider the evolution of e-procurement to be a slow process, with traditional procurement continuing to play a central role in purchasing. As one participant suggests, “E-procurement is the next evolution, but it’s taking a huge amount of time.” An interesting finding from this research, is that the barriers to e-procurement are being challenged at a corporate level. One participant states, “It would be a goal for us to be doing more purchases on-line and to reduce our transaction costs.” This current study has found that some MNCs are promoting the use of reverse auctions. One participant notes, “The reverse auction is a tool that we are using, and from a corporate level, their use is being promoted more and more going forward.” Companies are examining future possibilities for e-procurement, as one participant notes, “There is a project ongoing to look at the procurement system for raw materials.” In the future, there could be integration between suppliers’ e-procurement systems and customers’ ERP systems. One participant suggests, “Once that convergence happens, you will be able to send an electronic order across to the supplier’s system as a flat file, an XTML (extensible telephony markup language) file, or whatever it’s going to be; like you have with the electronic invoice now. And, their system will be able to decode it and upload it to their own system.” Public sector organisations are also examining the possibilities of further integration of e-procurement. One respondent notes, “A consortium has been set up to look at the whole procurement process, including on-line purchasing.”

### **5.6. Recommendations for B2B and B2G E-Procurement Transactions in Ireland**

The authors wish to make the following recommendations based on the findings of this current research:

- For MNCs involved in manufacturing, their ERP systems could be integrated with suppliers’ e-procurement systems to:
  - Automatically process an order for all of the items listed from a PO generated by the customer’s system, complete with necessary approvals.
  - Interrogate the customers’ stock levels for critical items and replenish them automatically when they reach a certain re-order point.
  - Allow the customer to automatically interrogate the system to create reports for tracking orders, and to show spending patterns and purchase history.

The integration should take place externally from the customers system to comply with its security policies, using an external database (possibly utilising the cloud computing concept). Contracts could be negotiated annually. This integrated e-procurement system would allow MNCs to maintain stock levels for crucial raw materials. It would allow reporting needed for management, while also satisfying the Sarbanes-Oxley regulatory requirement for U.S. companies.

- MNCs should consider collaborating on global e-auction projects to leverage the economies of scale and to share the prohibitive cost of running e-auctions.
- Public sector on-line tendering systems could be integrated with suppliers' e-procurement systems. This integration could:
  - Automatically process an accepted on-line tender into a purchase order.
  - Allow the customer to automatically interrogate the system to create reports for tracking orders, and to show spending patterns and purchase history.
- To make e-procurement a more viable option for SMEs, and allow them to find suitable suppliers more quickly, the following is recommended:
  - Suppliers could collaborate on market sites based on industry sectors.
  - SMEs could use a similar approach to MNCs and public sector organisations, and negotiate annual contracts with chosen suppliers, to provide standard frequent purchases through on-line catalogues.
- In order to assist the provision of capital purchases or more complex purchases through e-procurement Web sites, the following is recommended:
  - Suppliers could provide intelligent decision support systems to offer advice to the customer and to guide them through the decision process.
  - The e-procurement system could provide an option to view a movie or 3D animation of the product and its usage.
  - E-procurement systems could allow the customer to discuss requirements with a sales advisor who could propose solutions on-line. This could be supplemented by video through Web-cam.
- Suppliers should consider providing intelligent decision support systems to help in an on-line negotiation process. Pricing based on quantities ordered, commitments to future orders or purchasing supplementary items could be offered.
- There should be government-initiated standards, agreed on a global basis, to be used by software and hardware vendors in designing e-procurement systems.

## 6. Conclusions

The principal conclusions of this research show that traditional procurement methods continue to be the predominant means of purchasing in the private and public sectors in Ireland. E-procurement occupies a secondary role in most organisations, for the purchase of non-critical low value fast moving items, or for once-off low value purchases. It is not considered suitable for purchasing raw materials, capital items or complex purchases. SMEs in the ICT industry may be an exception, with a larger percentage of their purchases being done on-line.

According to Davila *et al.* (2003), the growth rate for e-procurement has been slower than predicted, because e-procurement technologies are still in the early stages of the technology S-curve. Alternative technologies are rapidly evolving, and users are still trying to sort out the winning model. The findings of this research support Davila *et al.* (2003) and the conclusion is that the technology for e-procurement and its full integration with organisations' processes is at an early stage. While organisations want to use e-procurement more, to reduce costs and introduce efficiencies, there are no clear standards yet emerging in practice, to resolve the key barriers that prevail, which is preventing e-procurement replacing traditional procurement methods.

## 7. References

- Afuah, A., and Tucci, C.L. (2003). *Internet Business Models and Strategies*, second edition, McGraw-Hill/Irwin.
- Awad, E.M. (2004). *Electronic commerce, from Vision to Fulfilment*, second edition, New Jersey: Pearson Prentice Hall.
- Batenburg, R. (2007). "E-procurement adoption by European firms: A quantitative analysis", *Journal of Purchasing and Supply Management*, pp. 182-192.
- Davila, A., Gupta, M., and Palmer, R. (2003). "Moving Procurement Systems to the Internet: The Adoption and Use of E-Procurement Technology Models", *European Management Journal*, vol. 21, no. 1, pp. 11-23.
- Hutt, M.D., and Speh, T.W. (2004). *Business Marketing Management, A Strategic View of Industrial and Organizational Markets*, eighth edition, Ohio: Thomson South-Western.
- Hsiao, M.H. (2009). "Shopping mode choice: Physical store shopping versus e-shopping", *Transportation Research, Part E* 45, pp. 86-95.
- Jelassi, T., and Enders, A. (2008). *Strategies for e-Business. Creating Value through Electronic and Mobile Commerce*, second edition, Financial Times Prentice Hall.
- Laudon, K.C., and Traver, C.G. (2007). *E-commerce, business. technology. society*, third edition, New Jersey: Pearson Prentice Hall.
- Phillips, P. (2003). *E-Business Strategy Text and Cases*. McGraw-Hill Education.
- Preston, P., and Cawley, A. (2008). "Broadband development in the European Union to 2012 - A virtuous circle scenario", *Futures*, pp. 812-821.
- Sharma, A. (2002). "Trends in Internet-based business-to-business marketing", *Industrial Marketing Management*, p. 77-78.
- Taylor, M.J., Mcwilliam, J., England, D., and Akomode, J. (2004). "Skills required in developing electronic commerce for small and medium enterprises: case based generalization approach", *Electronic Commerce Research and Applications*, p. 253.
- Turban, E., King, D., Viehland, D., and Lee, J. (2006). *Electronic Commerce 2006 a Managerial Perspective*. New Jersey: Pearson Prentice Hall.
- Tuttle, A. (2003). "'E'abling buyers", *Industrial Distribution 92 no4, Reed Business Information, a division of Reed Elsevier, Inc.*, pp. 55-58.
- Wang, T.C., and Lin, Y.L. (2009). "Accurately predicting the success of B2B e-commerce in small and medium enterprises", *Expert Systems with Applications*, pp. 2750-2758.

# Cork's Rebel Brand A Marketing Myth or Reality?

Sinead Gilroy, Dr. Angela Wright

Cork Institute of Technology  
sinead.gilroy@gmail.com, angela.wright@cit.ie

## Abstract

'The Rebels' is the colloquial name associated with the Cork G.A.A. (Gaelic Athletic Association) sports-teams and individual players. From a sporting perspective, 'The Rebels' enjoy a highly respected position among their peers, as skilled athletes and determined winners. In the 126 years of G.A.A. sporting history, 'The Rebels' senior teams, have captured 66 All-Ireland titles, in hurling, football (male and female), and camogie collectively (Cork G.A.A Web Site, 2010; O'Keeffe, 2009). This current study examines if such documented on-field success, has been appropriately leveraged to positively impact the commercial aspect of 'The Rebels' — specifically in terms of branding. The current research is an investigation into the off-field, branding phenomenon surrounding the Cork 'Rebel' sports-teams.

The principal finding of this current research is that a 'Rebel brand' does exist and significantly, in terms of its market position, it is considered to be a 'birthright' to all Cork natives. This study observes a vibrant 'Rebel brand', imbued with emotion. The brand success is found to be directly underpinned by the success of the 'Rebel' on-field achievement, particularly in terms of All-Ireland championship titles won. This 'Rebel brand' is self-evolved however, and survives without active strategy or purposeful brand management on the part of Cork G.A.A.. The findings of this current study illustrate that the 'Rebel brand' is underdeveloped from a marketing perspective. The 'Rebel brand' that was categorised through this current study is one with distinctive brand insistence, elevated brand engagement and categorical brand equity. According to Robins (2001), some brands simply have a magic. This current research finds Cork's 'Rebel brand' to be one such brand.

## Keywords

Branding, Brand Equity, Sports-team Branding, Brand Loyalty, G.A.A., Commodification, Brand Community, Brand Promise, Brand Damage, Sporting Amateurism.

## 1. Introduction

Sports-teams have evolved in the last thirty years, and where once the primary objective of a sports-team was to provide sporting entertainment to loyal fans, today sports-teams have become brands in their own right, with the focus to attain the greatest level of financial return possible. Such is the power of sports-team brands

such as the Manchester United Football Club or the New York Yankees baseball team, that the fan-base is global, allowing the brand management to generate global revenue. Fundamentally, this current paper assesses such a sense of uniqueness does reside in the Cork 'Rebel' ethos and will investigate if such an inimitable and intangible characteristic has been transferred from on-field performance, to off-field success, and developed into a branding phenomenon.

## 2. Background to This Study

The incident that initiated this current research investigation was the 2008 Cork senior hurlers' withdrawal of playing services<sup>1</sup>, which took place from November 2008 to March 2009. The team withdrew their playing services, as they had informed the County Board that they did not wish to work under the management of Gerald McCarthy (Moynihan, 2009 ; O'Grady, 2009). The demonstrative actions of Cork 'Rebel' fans during the strike, prompted the researcher to consider the Cork 'Rebels' from a marketing perspective. The researcher was propelled to investigate if the intense levels of fan commitment towards the 'Rebel' sports-teams was being transferred and utilised from a purely sporting context (on-field), into a more marketable, business context (off-field).

## 3. Literature Review

The most far-reaching and powerful influence on modern sports is the highly developed process of 'commodification' which refers to the manner in which sports are increasingly being shaped by a market rationality (Kew, 1997). Kew (1997) adds that it is of crucial importance for sporting organisations to ensure that the integrity of sport is protected in the face of potentially exploitative and manipulative commercial interests. According to Mottram (1998), corporate branding is now spreading beyond the realm of the organisation, as other types of non-corporate (and non-traditional) organisations such as charities and football clubs are acknowledging that they too possess unique intangible assets.

According to the Irish Sports Council (2006), the economic value of sport in Ireland is estimated at €1.4 billion, or 1.3% of Gross National Product, and this figure is related only to social participation in sport. The Gaelic Athletic Association (G.A.A) was founded in 1884 as part of the wider Gaelic revival movement (Delaney & Fahey, 2005). The G.A.A. brand is described as one of the most powerful, attractive and marketable brands in Ireland. (G.A.A, 2009a). The GAA has more than 2,500 clubs established in Ireland and more than 400 international clubs supported by the Irish Diaspora (GAA Web Site, 2009 ; Delaney & Fahey, 2005). According to Cork GAA Web Site (2010), the county currently holds 30 senior All-Ireland Hurling titles and 7 senior All-Ireland football titles. Cork also holds 24 women's senior camogie

---

<sup>1</sup> From November 2008 to March 2009, the Cork Senior hurling team withdrew their playing services, due to a dispute with the team management (The Cork County Board). This incident is referred to as the withdrawal of services, or the strike, interchangeably throughout this paper.



All-Ireland titles and the Cork women's football teams have won 5 All-Ireland senior championship titles (O'Keefe, 2009). By 2004, Cork G.A.A. had yearly assets worth fifteen million euro and a turnover in excess of nine million euro (Cronin, 2005). In terms of spectatorship the GAA dominates accounting for more than fifty percent of all attendances, followed by soccer and rugby (Irish Sports Council, 2006).

According to Thompson & Sinah (2008), organisations with strong brand communities enjoy significant advantages over their rivals. Devasagayam & Buff (2008) suggest that in sports team branding, this next-level-loyalty or 'Passionates' are a key part of the brand community, represented by those with high game attendance, desiring fan events, and wanting interaction with players and other fans. Online sites such as Facebook, MySpace, Twitter and LinkedIn are leading the way in this new frontier for developing deeper relationships between brands and their customers (Bove, 2008). According to Haue-Pedersen (2004), the sports organisations that have understood the power of branding, have been able through its implementation, to greatly increase general public interest, push participation numbers at grass roots levels, and raise overall revenue. Frampton (2008) proposes that a challenging economy is an opportunity for brands to create and secure value and in such difficult times, customers rely increasingly on brands for their decision making.

#### **4. Research Methodology**

A qualitative research approach via semi-structured interviews was deemed most appropriate for this paper, having considered the following factors:

- Given the sensitivity toward the Cork Hurlers strike and the raw element still existent among the general public, particularly in Cork, the researcher believes that a qualitative approach will allow for greater objectivity among respondents and provide a better model for obtaining a less passionately irrational or biased response that may have resulted from a general public questionnaire (quantitative) approach.
- The topic of investigation is inherently very insulated within Cork city and county, and considered not as relevant outside of Cork. For this reason, the researcher considers that a quantitative approach within Cork could not produce a balanced response. If a questionnaire were to be administered outside of Cork, on the other hand, the researcher believes that the opposite would occur, where oppositional loyalty would be too strong a factor to provide a balanced response.

## 5. Findings and Discussion

The findings of this study reveal that 64% of interview respondents believe that the term 'Rebel' is the colloquial or affectionate name, associated with any Cork G.A.A. football or hurling team, or member thereof. The name 'Rebel' is considered to be exclusively attached to Cork G.A.A. Underpinning this strong definition of the term 'Rebel' is the perception among research contributors that on-field achievement and success has been the historic determinant for meriting such an association. Consistently, winning All-Ireland finals is crucial to maintaining the strength of the 'Rebel' name. A very significant finding of the current paper is that just 9% of contributors to this study, considered the Cork ladies G.A.A. teams to be deemed 'Rebels'. Interestingly, at the time of research for the current paper, the Cork ladies senior camogie team and football team ('The Rebelettes') had won the 2009, All-Ireland final. Neither of the men's senior 'Rebel' teams — hurling or football — had won an All-Ireland title in 2009.

The findings of this current paper imply that the origins and ownership of the 'Rebel brand' are significant factors in elevating the position, and driving the success of the brand. This current paper found that the wide perception is that the term 'Rebel' has deep-set roots in Irish national history, and that it originated around the time of the 1916 Rising and Civil War of Independence. 91% of contributors to this study supported such a view, expressing an association and connection with strong historic characters such as Michael Collins (Irish revolutionary) and Terrence McSwiney (Former lord-mayor of Cork). Strong characteristics and determined personalities were widely acknowledged by the study contributors — 55% — to be essential components of 'Rebel DNA'. The very strength of the name — 'The Rebels' — is seen by a large percentage of interviewees (64%) to be significant to its success. The study reveals that 55% of interview respondents acknowledge the inexplicably influential effect that the red-coloured team jersey has, in contributing to 'Rebel brand' equity. In parallel, a weakness uncovered in the findings of this study surrounds the 'Rebel' brand's unique association — the area of the 'Blood and Bandage' — the 'Rebel' teams' official jersey of red and white. The findings of this current research show that the name 'Blood and Bandage' with its historical origins and emotional context, is not being effectively utilised in communications regarding the 'Rebel brand', and there is a definite sense of confusion and lack of awareness encircling this potentially powerful 'Rebel brand' association. The 'Blood and Bandage' was never heard of by 45% of contributors to this current paper. Another principal finding of this current paper is that respondents frequently made reference or comparison to Manchester United and Munster Rugby throughout the interview. Such comparisons indicate the very positioning of the 'Rebel brand', in that it is so often compared and contrasted to 'best-in-class' sports-teams and sports-team brands.

Brand sponsorship was also found to be a factor in determining the origins of the 'Rebel brand' however this study uncovered complications surrounding 'Rebel brand' management, 36% of respondents view O2, the sports-teams sponsor, as the visible brand surrounding 'The Rebels', rather than actually recognising a 'Rebel

brand'. 36% of respondents were able to cite winning statistics for the Cork 'Rebel' teams, indicating strong levels of brand engagement and awareness. This current paper found, that with the 2008 Senior Hurling team's withdrawal of services, some type of intimidation or pressure is perceived to have occurred off-field between team members, which negatively affected the perception of, and position of, the 'Rebel brand' among fans.

A resounding belief among this study's respondents is that a Cork Rebel must live up to a certain standard or image of Rebel as perceived by the public and the fans, which is considered a part of the 'Rebel brand' promise. This current paper identifies such a pattern, in that the interview respondents for this current paper, believe that there is a 'Rebel Instinct' among 'Rebel' team members, existing through the annals of time, incorporating rebelliousness, determination, dedication and willingness at all costs to succeed. Staying true to this promise and instinct critically correlates to brand loyalty. The integrity of the Cork 'Rebel brand' promise is also shown to be related to player off-field behaviour and this study finds that the 'The Rebels' understand and respect this relationship. Importantly from a brand equity perspective, this study has found that if 'Rebel' players are involved in any type of deviant off-field behaviour, this would impact negatively on loyalty levels and dilute the overall brand strength.

There is a deeply strong emotional connection existing between G.A.A. sports-teams and the local originating community or parish. 91% of contributors to this current study acknowledge this strong link to community and parish. This paper acknowledges the important social significance that results from the sense of community and culture surrounding the G.A.A., specifically in rural areas as identified by 35% of respondents. Interestingly, this paper also found that although the G.A.A. does not hold such a dominant position in countries outside of Ireland, the original community attachment and pride in the parish, has been transferred overseas. Irish Diaspora have a huge affiliation to the G.A.A. abroad and utilise their local organisation as a place to meet people, as they would in Ireland. Additionally, this current paper has found that a contributing factor to the uniqueness of the G.A.A. community attachment is the fact that the G.A.A. players are more 'ordinary' — they are local people, local heroes that are approachable when compared to highly paid soccer players for example. This unique amateur status of G.A.A. sports and the associated non-payment of players is the key driver for the success of the G.A.A. broadly, and the Cork 'Rebel brand' more specifically. 73% of interview respondents concur and articulate a clear comprehension of the role of amateurism in the development of Cork's 'Rebel brand'. This intangible, emotional element of the 'Rebel brand' is a primary contributor to its brand equity.

A very noteworthy finding of this current research is that up to 2009, there has been little or no marketing spend by Cork G.A.A., to craft the emotional attachment from the public to the 'Rebel brand'. Although this study has proven that the traditional community and culture surrounding the 'Rebel brand' is continuously flourishing, 82% of interviewees could not refer to any type of contemporary marketing supporting Cork's 'Rebel brand'. This finding demonstrates and validates the under-

development of the brand. Modern media methods such as blogs, websites and online communities are not being used by the G.A.A. nationally, or more locally, in Cork to develop and promote the ‘Rebel brand’.

With the predominant emotions driving the success of the ‘Rebel brand’ identified as pride and passion, it is considered exceptional and unnatural for an individual to follow any other club outside of their own locality. Following from the finding that the ‘Rebel brand’ loyalty originates at club level, this current paper further found that the primary driver of such loyalty is success — 73% of respondents confirmed that the success of the ‘Rebel brand’ on-field correlates tightly with the level of ‘Rebel brand’ loyalty existing. Reinforcing this claim is a notable finding of this paper — that the Cork ‘Rebel brand’ has shaped a ‘next-level’ of loyalty among many fans and this is the intangible, irrational and immeasurable element of ‘Rebel brand’ loyalty. This study found that the G.A.A. as an organisation, both at a national and a local level, is not assisting or contributing to the development of such a sense of brand tribalism towards the ‘Rebel brand’.

This study also uncovers that the ‘Rebel brand’ is an exceptionally robust brand as 64% of interview respondents believe that in the long-term the brand was not significantly damaged by the controversial 2008 senior hurling team’s withdrawal of service but instead may actually have been fortified by this incident. This current paper has found that the success of the ‘Rebel’ sport-teams on-field tightly correlates with the limited level of damage created by the withdrawal of services. However, the findings also warn that potentially damaging incidents such as the strike / withdrawal of services can affect the long-term stability and development of the ‘Rebel brand’, as these younger players may now decide to turn away from hurling / G.A.A. There is also a belief remaining among the contributors to this current research paper, that maybe this strike is not yet over.

From an external damage perspective, this paper found that 82% of interview respondents believe that the ‘Rebel brand’ will be naturally affected by recession, but solely in terms of financial revenue, and that this affect of recession will not cause any image related damage to the ‘Rebel brand’. This current paper found that the merchandising aspect of the ‘Rebel brand’ is the area that would most likely be affected by the recession — as 45% of contributors expressed this view. In parallel, this current paper did uncover potential external damage affecters to the ‘Rebel brand’ which can affect team loyalty — Munster Rugby is considered to be one such sporting team that may potentially cause ‘Rebel brand’ damage — if it was to be more effectively developed at grass roots level.

The above findings prove that a sports-team brand can emerge and thrive without deliberate or significant marketing or financial support. Such results could be transferred to other dominant G.A.A. sports-teams, such as Dublin (‘The Dubs’) and Kerry (‘The Kingdom’), or even applied on a broader scale to other types of sports entirely. This paper recommends that organisations that manage prominent sports-teams with high levels of fan loyalty, and particularly next-level-loyalty, should

engage in similar and auxiliary research in order to learn how to most effectively develop and manage the brand.

This current paper has found a significant disparity between how the men's 'Rebel' sports-teams, and the women's 'Rebel' sports-teams are viewed by the public, managed by the Cork County Board, and positioned in the marketplace in terms of branding. There is potential for future research, to examine if this evident imbalance reflects a version of gender based employment discrimination — 'the glass ceiling effect'. Although as previously noted, all G.A.A. sports are of amateur status, and the players do not get paid to play, there is a further area of potential investigation open here, to determine if this treatment of the women's 'Rebel' sports-teams is transferred off-field into the full-time employment positions of the women 'Rebel' players. Do the women 'Rebel' players achieve the same employment opportunity as the male 'Rebels'?

Finally, during the current research process for the current study, it became evident that G.A.A. sports in general and specifically, the Cork 'Rebels', although do not have a strong international presence, do have a very strong following abroad. This is due primarily to the very localised nature of the sport and the emotional attachment to the originating community — Cork. As this research paper has found, the 'Rebel brand' to be a legacy brand for all Cork natives, at home and abroad, there is potential to draw off the strong levels of nostalgia associated with this brand, to assess if the localised commercial success could be transferred to an international scale.

## 6. Recommendations for Practice

The recommendations proposed below, could be implemented by Cork County Board in order to assume control of the 'Rebel brand', and in order to fortify the current market position of this sports-team brand.

- **Cultivate the Rebel Name and Logo:** — The 'Rebel brand' name and 'Rebel brand' logo are not adequately protected from imitation or appropriately utilised as formidable marketing communications tools. This paper strongly recommends that the 'Rebel brand' name and 'Rebel brand' logo be legally protected, preferably by trademark. The logo should become synonymous with the name and instantaneously identifiable.
- **Embark on a brand-building exercise:** — The future 'Rebel brand' strategy should be leveraging the brand promise, uniqueness, culture and amateur status to strengthen existing consumer bonds and to create new consumer relationships and new markets. The compelling emotions of passion and pride should be sufficiently targeted and utilised in branding and marketing communications for the 'Rebel brand'. A primary objective should be to ensure that the 'Rebel brand' becomes the dominant commercial brand surrounding the Cork 'Rebels'.

- **Augment the ‘Rebel brand’ with Contemporary Marketing:** — A considerable portion of the ‘Rebel brand’ consumers are younger people, for whom blogs, Twitter, Facebook, MySpace and other such social networking tools are naturally incorporated into their everyday life. The Cork County Board will need to address this unfamiliar technological territory in order to move closer to the ‘Rebel brand’ consumer / fan.
- **Integration of the Cork Women’s G.A.A. Sports-Teams:** — This current research recommends that the integration of all Cork G.A.A sports-team websites (men’s and women’s) should occur, resulting in one ‘parent’ website, providing information for all ‘Rebel’ sports-teams. This current research recommends the area of ‘Rebel’ sponsorship to be re-assessed and the possibility of incorporating the women’s teams into the sponsorship package should be examined.
- **Fuse Tourism and the ‘Rebel brand’:** — Currently, in 2010, there are no ‘Rebel’ related tourist attractions in Cork, except for a very minimal amount of ‘Rebel’ memorabilia in the City Museum. It is recommended that the Cork County Board and Fáilte Ireland fuse this natural love of all things ‘Rebel’ related, by the Irish Diaspora, with the potential for such people to visit Cork as tourists, in order to provide these visitors to Cork with interesting ‘Rebel’ tourist amenities.
- **Revival of the ‘Blood and Bandage’ :** — This current research recommends that the Cork County Board aims to revive and strengthen the ‘Blood and Bandage’ association to the Cork ‘Rebel’ sports-teams. This could be achieved by using the phrase ‘Blood and Bandage’ in advertising or articles in match programs, on ‘Rebel’ merchandise and other marketing promotional materials.
- **Controlling Recessionary Damage:** — From this study it is recommended that ticket prices and ‘Rebel’ merchandise be reduced in price. This short-term brand bolstering strategy, will work to enhance the ‘Rebel brand’ as the already very loyal ‘Rebel’ fans will feel a closer bond, and sense of appreciation towards Cork G.A.A. — ticket sales would remain relatively stable, and loyalty levels may increase.

## 7. Conclusion

The ‘Rebel Brand’ is an intensely strong brand with high levels of brand awareness and enduring commitment and brand loyalty among Cork people. Rich in culture, the ‘Rebel brand’ enjoys the coveted position of heritage brand with natural engagement by Cork natives. The success of the ‘Rebel brand’ is directly driven by the on-field achievement and success of the ‘Rebel’ sports-teams, the strong emotions surrounding the brand and the dedication and determination of all those involved with the ‘Rebel brand’. The ‘Rebel brand’ enjoys very high levels of resilience, however is not absolutely robust.

The ‘Rebel brand’ philosophy is traditional, however, it embraces contemporary ethics and authenticity. The ‘Rebel brand’ is a self-evolved brand in that it did not

emerge or develop as a result of deliberate strategy on the part of Cork G.A.A. / Cork County Board. It is thus, a relatively underdeveloped commercial brand, in that the true strength of the brand has not been adequately exploited for financial gain. Modern marketing methods have not been undertaken to develop the brand. The brand is at risk from natural recessionary damage, but more importantly is exposed to any type of sporting related deviance and damage. The brand currently maintains a very captive following which must be fully protected as the sporting landscape is rapidly changing. A 'Rebel brand' that emerged, developed, survives and thrives without branding strategy or planned marketing support, is indeed a magical brand.

## 8. References

- Bove, J. (2008), "Brand Building 2.0", *Display & Design Ideas*, vol. 20, issue 10, p. 38.
- Cork G.A.A Web Site (2010), <http://www.corkgaa.ie> (Accessed 8 December 2010).
- Cronin, J. (2005), *Making Connections. A Cork G.A.A. Miscellany*, Ireland: Cork County Board.
- Delaney, L. & Fahey, T. (2005), *Social And Economic Value of Sport In Ireland*, Dublin: ESRI (The Economic and Social Research Institute).
- Devasagayam, P. R. & Buff, C. L. (2008), "A Multidimensional Conceptualization of Brand Community: An Empirical Investigation", *Sport Marketing Quarterly*, vol. 17, no. 1, pp. 20-29.
- Frampton, J. (2008), "The Red Thread: The true power of a well-managed brand", Accessed from [http://www.interbrand.com/papers\\_lists\\_aspx?langid=1000](http://www.interbrand.com/papers_lists_aspx?langid=1000) (Accessed 26 February 2009).
- G.A.A. (2009)a, *Annual Report 2008*, Dublin: G.A.A. Annual Congress.
- G.A.A. (2009)b, *The GAA Strategic Vision and Action Plan 2009-2015*, Ireland: Gaelic Athletic Association.
- G.A.A. Web Site (2009), <http://www.gaa.ie> (Accessed 27 July 2009).
- Haue-Pedersen, L. (2004), "Why is Branding so Important?", *Fiba Assist Magazine*, October 2004, p.47-8, Accessed from [http://www.fiba.com/asp\\_includes/download.asp?file\\_id=406](http://www.fiba.com/asp_includes/download.asp?file_id=406), (Accessed 8 June 2009).
- Horne, J., Tomlinson, A. & Whannel, G. (1999), *Understanding Sport. An introduction to the sociological and cultural analysis of sport*, USA: E & FN Spon.
- Irish Sports Council / ESRI, (2006), *Ballpark Figures. Key Research for Irish Sports Policy*, Ireland: ESRI.
- Kew, F. (1997), *Sport: Social Problems and Issues*, UK: Butterworth-Heinemann.
- Moynihan, M. (2009), "Rebel hurlers show united front", *Irish Examiner*, January 1, p. 1.

Mottram, S. (1998), "Branding the Corporation" in (eds) Hart, S & Murphy, J., *Brands, The New Wealth Creators*, London: MacMillan, pp. 63-71.

O'Grady, D. (2009), "No man bigger than Cork hurling", *Irish Examiner*, January 22, p. 27.

O'Keeffe, B. (2009), "Rolls of Honour", Accessed from [www.corkgaresults.com](http://www.corkgaresults.com) (Accessed 21 September 2009).

Robins, M. (2001), "Brains and Brands", *Forbes*, vol. 168, issue 7, p. 156.

RTE Web Site (2009), <http://www.rte.ie/sport/index.html>. (Accessed 27 September 2009).

Thompson, S. A. & Sinha, R. K. (2008), "Brand Communities and New Product Adoption: The Influence and Limits of Oppositional Loyalty", *Journal of Marketing*, vol. 72, no. 6, pp. 65-80.



# Viral Marketing: The Future Next Generation

Vicky O’Sullivan and Dr Angela Wright

Cork Institute of Technology

e-mail: Vicky.osullivan@cit.ie Angela.wright@cit.ie

## Abstract

This paper is an assessment of the technological evolutions, principally developments in electronic and digital social media, which have introduced new marketing paradigms, such as viral marketing. Viral marketing is a new phenomenon which offers marketing practitioners significant opportunities to reach target audiences in a credible and attention grabbing way. Subramani and Rajagopalan (2003) posit that “viral marketing is the tactic of creating a process where interested people can market to each other, and is therefore emerging as a powerful means to ‘spread-the-word’ and stimulate the trial, adoption and use of products and services” (2003: 300).

Viral marketing enables on-campus organisations to engage tertiary level educational students where they live, socialise and study. The quintessential viral marketing campaign will enable the on-campus marketer to rapidly disseminate a marketing message through electronic word-of-mouth or, ‘word-of-mouse’, and ultimately generate product, or service, awareness among student bodies. This paper investigates the key factors that affect the implementation of effective viral marketing strategies by on-campus organisations within tertiary level educational establishments, and contends that viral marketing strategies are extremely relevant to closed environments and institutions such as, tertiary level educational establishments.

## Keywords:

Viral Marketing, Tertiary Level Education, Social Networking, Social Technologies, Effective Targeting.

## 1. Introduction

Viral marketing involves the diffusion of a marketer’s messages across consumers’ personal social networks at an exponential rate, by leveraging new social media, such as mobile, internet and Web technologies, and in so doing, increases the reach of the marketing message relative to the target audience. Hill *et al.*, (2005) posit that the aim of viral marketing is to increase the awareness or adoption of a product, or service, by exploiting the relationship networks among consumers. Porter and Golan (2006) define viral marketing as “unpaid peer-to-peer communication of provocative content originating from an identified sponsor using the internet to persuade or influence an audience to pass along the content to others” (2006:33).

Reaching students in tertiary level education has for marketers, including those practitioners from organisations who are situated on-campus, become a challenging undertaking. Yin (2003) purports that “consumers today are mercurial targets, but few groups present as daunting a challenge to marketers as college students” (2003: 20). Traditional on-campus marketing communication tools, such as fly posting, flyers, college magazines and information leaflets have become fragmented and cluttered. Students frequently disregard these media, or, even more significantly, fail to become aware of them as they filter out marketing paraphernalia from their consciousness due to the incessant proliferation of on-campus and off-campus organisations targeting them. Through non-traditional marketing paradigms, such as viral marketing, it becomes possible for on-campus organisations to engage tertiary level educational students where they live, socialise and study. The quintessential viral marketing campaign will enable the on-campus marketer to rapidly disseminate a marketing message through electronic word-of-mouth or, ‘word-of-mouse’, and ultimately generate product, or service, awareness among student bodies through this credible and attention grabbing approach.

While this research study found that viral marketing is firmly established and supported by marketing practitioners in the macro-environment, there has been little, if any, research undertaken to investigate its applicability to a micro-environment, such as, a tertiary level educational establishment. This paper presents new empirical data which demonstrates that viral marketing strategies can be successfully executed within a tertiary level educational establishment.

## 2. Literature Review

Niederhoffer *et al.*, (2007) suggest that growing forms of media, such as the internet and mobile devices, coupled with the declining reach of many traditional media have driven marketers to gain a better understanding of this complex communications ecosystem in order to manage, or better influence, the outcome. Chester and Montgomery (2008) concur, and posit that “the new marketing ecosystem incorporates cell phones; mobile music devices, video games and virtual three dimensional worlds. New practices are fundamentally changing how marketers target young people” (2008: 11). Woerndl *et al.*, (2008) believe that the rapid growth of the internet and the emergence of interactive media facilitated by internet technologies are changing the drivers that define how marketing techniques and business practices are developed and refined. According to Lamb and Johnson (2006), “social technology refers to computer-mediated communication environments that connect people for cooperation, collaboration and information sharing” (2006: 55). Goh *et al.*, (2006) state that people are using electronic media, such as electronic mail (e-mail), more frequently for communications, and using online channels, such as social networking sites (SNS) to build and maintain social relationships. According to Farkas (2008), SNS, such as ‘Facebook’ (facebook.com), allow people to easily make friends, and share ideas on the Web. Subramani and Rajagopalan (2003) purport that SNS are increasingly being accepted as an important source of information that influences the uptake and use of products and services:

*Navigating for information via social networks works better than other methods like the internet when people are searching for information that is location-specific, community-specific, or time-specific. This is because people are good sources of these types of information, e.g., a good pizza place in Toronto* (2003: 243).

Leskovec *et al.*, (2007) agree that SNS is constructed by using information that is geographically, age, or interest related. Boyd and Ellison (2007) support this argument, and state that even though SNS are often designed to be widely accessible, many attract homogeneous populations initially. It is not unusual, to find groups using sites to segregate themselves by nationality, educational level, or other factors that typically segment society (Leskovec *et al.*, 2007). Goh *et al.*, (2006) posit that the need and desire of people to ‘stay connected’ to each other is encouraging several of the changes that are occurring in the extensive wireless mobile device market. According to Grinter and Elridge (2001), text messaging (texting) is a noteworthy form of communication worldwide, principally among younger generations and is used for three broad purposes including chatting, communication, coordination and planning activities. Gander (2001) purports that Short Message Service (SMS) is a more far-reaching medium than television, and is particularly effective, with younger consumers. Bauer *et al.*, (2005) explain that, due to the development of high-speed wireless technologies, and the increasing market penetration of mobile phones with internet connectivity, there is an increase in the global marketing industry’s interest in mobile marketing campaigns. Chester and Montgomery (2008) purport that marketers have forcefully moved into SNS, taking advantage of their detailed consumer profiles and expanding contact lists, which facilitate extensive targeting. Currently, social technologies are blurring the line between what is marketing and what is not (Chester and Montgomery, 2008). De Bruyn and Lilien (2005) concur, and state that, due to the growth and evolution of the internet, electronic referrals have become an important phenomenon, and marketers have tried to exploit their potential through viral marketing campaigns.

Mohr (2007) states that viral marketing is an internet based and impersonal ‘word-of-mouth’ strategy that empowers and encourages people to pass along a marketing message, creating the potential for exponential growth in the message’s exposure and influence. Goldsmith (2002), Kaikati and Kaikati (2004) and Howard (2005) state that viral marketing is simply ‘word-of-mouth’ marketing via an electronic, or, digital platform, such as e-mail or text messaging. Dobeles *et al.*, (2005) concur, and state that “viral marketing can be defined as making e-mail into a form of advocacy, or ‘word-of-mouth’ referral endorsement, from one client to other prospective clients” (2005: 144). Lindsay (2005) posits that, with internet and mobile phone technologies, spreading a message by ‘word-of-mouth’ has become possible on an enormous scale through e-mail and text messages, and marketers have tried to harness this trend with ‘viral marketing’ campaigns to create a ‘buzz’ of excitement around a new brand, or service. Fill (2006) concurs, and notes — “this is effectively ‘word-of-mouth’ (word-of-mouse) communication, and as such has very high penetration” (2006: 158). According to Kaikati and Kaikati (2004), the receipt of a personal recommendation by means of e-mail from someone known to the recipient

is far more credible than an anonymous e-mail. Bickart and Schindler (2001) agree, and note that, like ‘word-of-mouth’, electronic ‘word-of-mouse’ may have greater credibility, empathy and relevance to customers than marketer generated information on the Web.

According to Poore (2007), viral marketing is unique in comparison to mass advertising since the message must be directed to the target audience in order to be successful. Phelps *et al.*, (2004) purport that, as electronic mailboxes become more crowded, consumers often hit the delete key when they know the message is from a marketer, but are less inclined to delete a message from a person they know. The fact that consumers are more likely to delete messages from marketers and less likely to delete messages from acquaintances is a key component in understanding the potential power of viral marketing (Phelps *et al.*, 2004). Dobeles *et al.*, (2005) believe that the sender who forwards the message will be more likely to know which of their friends, family members and work colleagues have similar interests, and thus are more likely to read the message, hence, more effective targeting. Lindgreen and Vanhamme (2005) concur, and add that friends know what surprises their friends, and are therefore, the most suitable people to forward messages. Fill (2006) contends that the most significant aspect of e-mail, for example, is its use as a viral marketing tool when it comes to reaching target audiences.

According to Bauer *et al.*, (2005) and De Pelsmacker *et al.*, (2007), marketers can, by utilising viral marketing, increase the reach of the marketing message to a targeted group that is much larger than the audience initially covered. Benson and Colburn (2008) purport that through the use of collaborative design and social networking tools, messages will reach target audiences, such as, student bodies in the spaces they frequent.

### **3. Research Methodology**

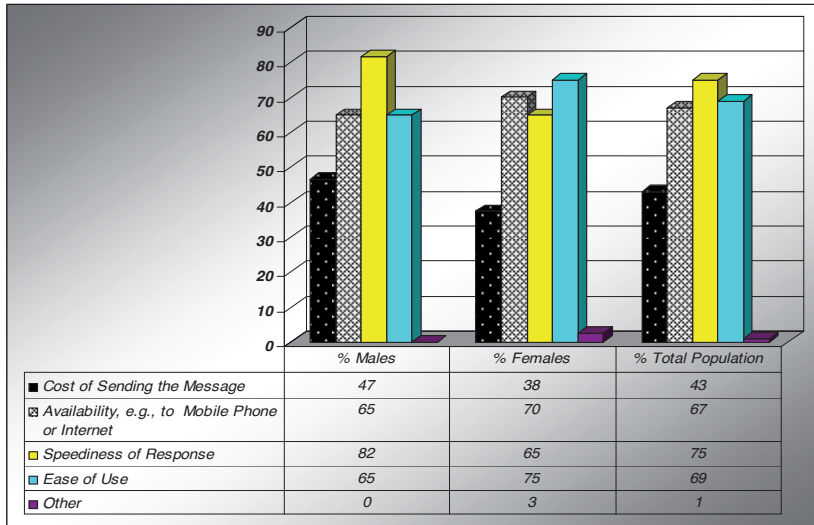
The empirical research in this study was conducted by utilising a quantitative methodology, and the questionnaire was selected as a suitable research tool. The research methodology is justified on the basis that, for the purpose of achieving the objective of this research, the researcher needed to investigate the behaviours and attributes of a large sample of the total population. The research design and data collection method involved the careful examination and execution of the questionnaire design process. This included examining question content, question phrasing and question response. The successful design of the questionnaire was achieved by consulting with experts and members of the sample population, and then piloting the questionnaire, followed by the subsequent refinement of the questionnaire which was comprised of seventeen questions. Due to the limitations of time and resources, and the large geographic spread of the population, a convenient sample of the population was selected based in one tertiary level educational establishment — Cork Institute of Technology (CIT). A number of lecturers were randomly selected and co-opted to act as interviewers, and these interviewers administered the questionnaires during timetabled classes. The researcher believed that an honest, larger response to the questionnaire could be achieved if the students could respond in a setting where they felt anonymous and comfortable, and could be

given time to answer the questionnaire. Randomly selected respondents were entered into the study until a sample size of one hundred was reached — resulting in a 100 % response rate. The researcher was available to interviewers if they had any follow up questions. The interviewers collected the completed questionnaires on a designated day, and they were subsequently passed onto to the researcher. Closed-ended questions were analysed using descriptive techniques, and open-ended questions were analysed using an inductive approach. This process was methodically and meticulously carried out to ensure the data was converted into sound, reliable and valid information.

#### **4. Discussion**

Gaining an insight into the new social and communicative technologies which are employed by students was integral to this research, since understanding the target audience's behaviour in terms of their communication practices is a fundamental requirement of planning and implementing a viral marketing campaign.

Notably, this research has found that 97 % of students prefer to use text messaging to communicate with other students within their own tertiary level educational establishment. The results show that the dominant factors that influence a student's choice of communicative medium are; the rapidity of the response to the message, the ease of use of the medium, the accessibility to the communication medium and the cost of sending the message. This finding is in line with Dobele *et al.*, (2005), who state that text messaging is less expensive than voice calling and text messages are easy to send. "These messages require no additional software and are particularly effective in targeting teens. In Japan, teenage consumers have become so adept at communicating via SMS messages that they have created a 'thumb culture' due to their ability to speedily 'thumb out' a message on the phone's keyboard" (Dobele *et al.*, 2005: 148).



**Figure 1: Influencing Factors of Respondents Choice of Medium to Contact Students within their own Tertiary Educational Establishment**

Counts (2007) states that mobile device based communication is evolving rapidly, expanding from voice and text, to include internet connectivity on mobile phones. This study has shown that students are dissatisfied with the level of computer based and wireless access to the internet in Cork Institute of Technology, and use internet based communication media less frequently than text messaging. This indicates that they are not willing to pay to avail of cost based internet connectivity on their mobile phones. Interestingly, according to research conducted by Divitini *et al.*, (2002), students in Scandinavia show a similar pattern of mobile phone usage. Scandinavian students use text messaging to communicate with fellow students, and rarely access the internet on their handsets due to lack of campus based wireless internet access (Divitini *et al.*, 2002). Correspondingly, according to research conducted by Kennedy *et al.*, (2008), a vast majority of Australian students rely on their mobile phones to call and text people, with 80% of students texting daily, but have not used their mobile phones to access web based information and services (67.8%) or to send and receive email (75.8%). The implications of all these findings are that cost and accessibility issues, as stated previously, are pivotal factors affecting the choice of communication media for students.

It is important to note that as well as exhibiting a strong preference for communicating with other students within their own college via text messaging, a noteworthy number of students also use SNS and e-mail to contact each other. Media sharing sites are predominately used by students to view videos, and these sites are more widely accessed by male students relative to their female counterparts. This study has found that the most popular SNS amongst students are 'Facebook' and 'Bebo' and the most popular media sharing site is 'YouTube'.

#### 4.1 Rapid Diffusion of Messages: Combination of Technologies

This research has found that the diffusion of the viral marketing message across a combination of internet and mobile based communication technologies will increase both the reach and frequency of the viral marketing message, and facilitate the proliferation of the viral marketing message as students become exposed to the messages at a number of key communication touch points. According to Tumulty (2007), Barak Obama, the current President of the United States of America aggressively and very successfully tapped into social technologies and found an innovative way to extend his campaign's reach by using the internet. Warner (2008) explained that a video posted on 'YouTube' which positively highlighted Obama, was spread quickly through 'blogs' and SNS. Green (2008) concurs, and notes that Obama also used text messaging to support his fund raising and election campaigns.

An important finding emerging from this current research is that a significant advantage of disseminating the viral marketing message to students across a combination of communication platforms is that it gives students the opportunity to choose which communication mechanism they will use to forward the message. This, for instance, will negate opportunities lost for the proliferation of the message due to fiscal considerations or limited access to the medium which, have an impact on students' proclivity to forward messages.

#### 4.2 Students Propagating Viral Marketing Messages

As stated previously, students do communicate with other students within their own tertiary level educational establishment using a combination of communication technologies. This is supported by Montgomery (2001), who notes that a prerequisite to achieving successful diffusion of a viral marketing message is that the population communicates freely with each other and college students fulfill this criterion. Lampe *et al.*, (2007) state that Social Networking Site communities generally correspond to existing offline communities, typically related to academic environments. Ghose and Dou (1998) assert that the Web changes the role of the customer from that of a marketing communication receiver, to an active participant in the marketing communication process. Balter and Butman (2006) state that the aim of viral marketing "is to manufacture a marketing message, typically online, and in a tangible format, such as a video clip or e-mail, that can spread among consumers quickly and exponentially", (2006:49). It is evident from this current research that students have a proclivity to forward marketing messages to each other, and thereby, do play an active role in the marketing communications process.

An interesting finding emerging from this study is that students have a greater proclivity to disseminate messages that originate from non-commercial on-campus organisations relative to commercial on-campus organisations. Importantly, this research, however, reveals that students are less interested in the organisation from which the message originates, but attribute more importance to the product, or service, that is the subject of the message. For instance, students have a greater

propensity to forward messages relating to sporting events as opposed to forwarding messages from the Sports Department.

### 4.3 Effective Targeting – Credibility

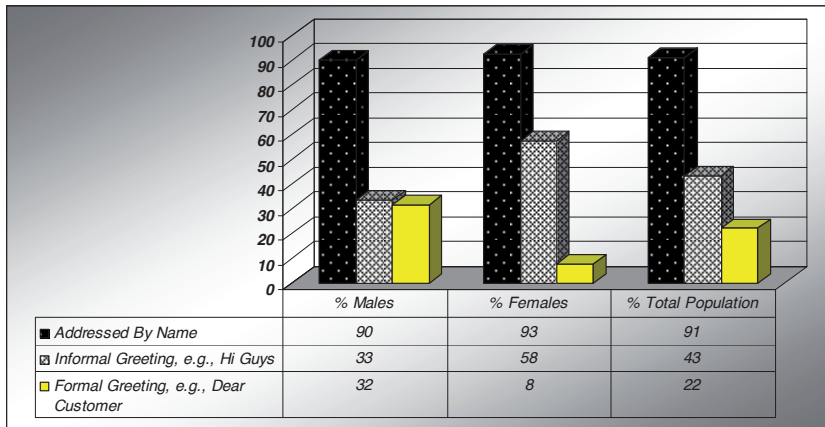
The findings of this research report that the selection of the initial individual students or group of students, to target within a tertiary level educational establishment's social network with a viral marketing message is critical to ensure the message is propagated throughout the network. Helm (2001) asserts that an important factor of successful viral marketing is that the first people to pass on the message are chosen very carefully. This research shows that students who are actively engaged with on-campus organisations are predisposed to forward messages from those organisations. This finding is pertinent to non-commercial organisations. The findings also show that students are less inclined to forward messages from on-campus commercial services compared with non-commercial services. No clear initial niche group who should be targeted with a message from an on-campus commercial entity was identified in this study. Female students, however, are more likely to forward messages from on-campus commercial entities relative to their male counterparts.

Chester and Montgomery (2008) posit that viral market researchers should target key influential young people who can serve as advocates, promoting products or services to their peers through social technologies. Chiu *et al.*, (2007) found, however, that people are not more likely to forward an e-mail sent by an unfamiliar, or, unknown friend than an e-mail from a commercial source, and therefore, a closer relationship between the e-mail sender and the receiver may result in a higher credibility perception, and hence more active forwarding behavior. According to the results of this research, students place the greatest trust in their friends when in receipt of messages which have originated from a marketing source, and interestingly, a very insignificant number of students place the most trust in class representatives when in receipt of a message. This finding thereby, supports the contention put forward by Chiu *et al.*, (2007).

A noteworthy trend, emerging from this research, is that 91 % of students will open messages that are addressed to them by name because they perceive such messages to be personal and relevant, or important, and because they believe the sender knows them and the message is "friendly" in nature. These findings are in line with Milne and Gordon (1993), who previously noted that consumers care about receiving messages that are relevant to them. While a small number of students will open formally, or informally addressed messages, they fear that these messages may contain a virus or spam. These are pertinent findings in relation to viral marketing since students must first be willing to open a message, before they can forward a message onto other students. De Bruyn and Lilien (2008) state that the first decision message recipients must make is whether or not they will open a message, and thereby, whether they will become aware of the message content. "At this stage, the only cues available to the recipient are the relevance of the subject line, the familiarity of the sender's name, and the nature of the relationship between sender and receiver. Potential benefits of opening the messages include, the possible



information value of the message content, or, the role that the message could play in strengthening the relationship with the sender, while potential costs and risks include; the possibility of wasting time, of being a victim of spam, of opening a harmful message (e.g., that may contain a virus), or, violating the sender's trust or expectations by ignoring a well-intentioned personal email” (De Bruyn and Lilien, 2008: 153).



**Figure 2: The Influence of the Address Format Relative to the Respondents Propensity to Open a Message**

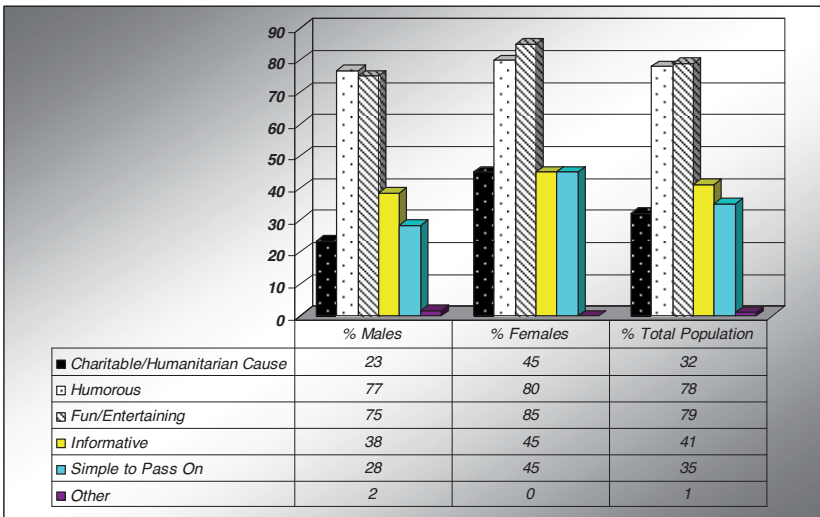
From this current study, it is evident that students are enthused to open messages from friends because, as stated previously, they trust friends, and they believe message from friends will be personal, interesting and important.

#### 4.4 The Impact of the Perceived Value of the Proposition

The findings of this research show that students are motivated to forward messages that relate to new products, or services. “Some consumers value the appearance of being on the cutting edge, or ‘in the know’, and therefore derive satisfaction from promoting new and exciting products” (Hill *et al.*, 2005: 3). Significantly, this research has found that students are highly susceptible to forward messages which offer free, or discounted, products/services. Welker (2002) expostulates that giving away free products is integral to many viral marketing campaigns which attracts attention, and engenders interest in products and services. Welker (2002) states, however, that a number of attributes of a message may be viewed as valuable, for instance, a consumer who is sufficiently amused by a cartoon based message may be motivated to share the message with friends, and thereby, the message stimulates forwarding behaviour. Conversely, this research has found that students are averse to, and will not forward messages which contain “unimportant information, chain mail, or excessive advertising”.

#### 4.5 Responsiveness to the Message Content

This research identified the characteristics of messages that prompt or prohibit the widespread propagation of the messages. The findings of this research show that 78 % of students will forward messages that are humorous, and 79 % of students will forward messages that are fun, or entertaining. This finding is supported by Fill (2006), who espouses that viral marketing works on the principle that messages are sent to a small part of the target audience, and the content is adequately humorous, interesting or persuasive that the recipient is bound to send it on to a friend. Dobele *et al.*, (2007) concur, and posit that a viral marketing message that contains humorous, or joy based content, is particularly effective when targeting younger consumers.



**Figure 3: Factors Which Positively Influence the Respondents' Propensity to Forward Messages**

### 5. Recommendations

It is reasonable to conclude that to effectively engage in viral marketing within a tertiary level educational establishment, on-campus marketing practitioners should employ a combination of text messaging, email, SNS (such as 'Facebook') and media sharing sites (such as 'Youtube') as diffusion tools in order to reach their target audience, and to achieve exponential growth of the viral marketing message. On-campus organisations need to target viral marketing messages to individuals, or specific groups, who are willing to forward the message to other students within their own tertiary level educational establishment. This study can recommend that non-commercial on-campus entities target individuals, or groups of individuals, with whom they have an existing relationship, for instance, the Sports Department should target on-campus sports team members with their viral marketing message. While no specific niche of individuals or group of individuals who are willing to propagate

messages from on-campus commercial entities emerged from this study, females have a greater propensity to forward messages from non-commercial entities than their male counterparts. This study can therefore strongly recommend that non-commercial entities should target female students with their viral marketing messages.

Students, who are the initial targets of the marketing message from an on-campus organisation, should be addressed by name. This study has clearly found that students believe personally addressed messages are relevant, important and are of specific interest to them. On-campus organisations engaged in viral marketing campaigns should strongly encourage students, who belong to the initial target group, to forward the message to their close friends. The success of viral marketing campaigns is dependent on the diffusion process being continuous, that is, the message must gain exponential growth and exposure in order to reach the maximum number of students in the target audience. Students trust, and are more interested in messages which they receive from their friends compared with messages that are forwarded from impersonal acquaintances. Students, therefore, are more likely to open messages sent to them by friends, and in turn, will continue the propagation process by forwarding the viral marketing messages to other friends. The content of the message is the most critical component in determining the success of a viral marketing campaign. On-campus organisations should ensure that the message is perceived to be of value to the target audience, that is, to students. The value should be fiscally, or emotionally, based, and these benefits should not be mutually exclusive. For instance, a free product, or service, can be offered within a message that is humorous in nature. This study can recommend that the message must also be clear and to the point, uncomplicated and simple to forward.

## **6. Conclusions**

This research has investigated viral marketing strategies based on its purist form — the diffusion of messages that have originated from the on-campus organisation engaged in the marketing of their products or services. Viral marketing leverages the internet and wireless mobile technologies, through the creation of a message by a marketing source that is perceived as valuable, (either in monetary or emotional terms) to the target audience. The viral message is then propagated across the consumer's personal social network. The process is continuous, with each consumer who receives the message sending it on to those in their personal social network, resulting in the exponential spread of the viral marketing message at no cost to the originator of the viral marketing message.

Viral marketing has been referred to in terms of large, and often geographically wide- spread target audiences, however, this research has examined the viability of implementing a viral marketing campaign within a closed environment, that is, a tertiary level educational establishment. Significantly, it has emerged from this study that viral marketing campaigns can be effectively executed within a tertiary level educational establishment. Many of the critical strategic factors of viral marketing which effect macro-environmental viral marketing campaigns will also

impact upon viral marketing campaigns undertaken in micro-environments, or closed environments, such as tertiary level educational establishments. These strategic factors include; gaining an understanding of which technologies are used by students to communicate with other students, identifying initial groups, or groups of individuals, to target with the viral marketing message, and ensuring the message content is conducive enough to compel the students to proliferate the message. In conclusion, this study has revealed, viral marketing strategies can be advantageously exploited by on-campus marketing practitioners to reach target audiences within tertiary level educational establishments in an innovative and compelling way. Viral marketing campaigns, if effectively executed, can provide significant advantages for on-campus organisations, which target student populations, such as providing a mechanism to breakthrough on-campus marketing ‘noise’ and ‘clutter’, overcome on-campus media fragmentation, cost-effectively reaches target audiences and disseminates marketing messages through trustworthy and credible channels.

## 7. References

- Balter, D. and Butman, J. (2006), “Clutter Cutter”, *Marketing Management*, 15, 4, July/August, pp. 49 - 50.
- Bauer, H. H., Barnes, S. J., Reichardt, T. and Neumann, M. M. (2005), “Driving Consumer Acceptance of Mobile Marketing; A Theoretical Framework and Empirical Study”, *Journal of Electronic Commerce Research*, 6, 3, August, pp. 181 - 192.
- Benson, D. and Colburn, S. (2008), “Party Photo Phenomenon: Students Collaborate to Promote Reference Service”, *College Resource Library News*, 69, 4, April, pp. 208 - 211.
- Bernoff, J. and Li. C. (200), “Harnessing the Power of the Oh-So-Social Web”, *MIT Sloan Management Review*, 49, 3, Spring, pp. 36 - 42.
- Bickart, B. and Schindler, R. M. (2001), “Internet Forums as Influential Sources of Consumer Information”, *Journal of Interactive Marketing*, 15, 3, Summer, pp. 31 - 40.
- Boyd, D. M. and Ellison. N. B. (2007), “Social Network Sites: Definition, History, and Scholarship”, *Journal of Computer-Mediated Communication*, 13, 1, December, pp. 210 - 230.
- Counts, S. (2007), “Group Based Mobile Messaging in Support of the Social Side of Leisure”, *Computer Supported Cooperative Work: The Journal of Collaborative Computing*, 14, 1-2, February, pp. 75 - 97.
- Chester, J. and Montgomery, K. (2008), “Marketing to Kids in the Digital Age”, *Multinational Monitor*, July/August, pp. 11 - 16.
- Chiu, H. C., Hsieh, Y. C., Kao, Y. H. and Lee, M. (2007), “The Determinants of E-Mail Receivers’ Disseminating Behaviours on the Internet”, *Journal of Advertising Research*, 47, 4, December, pp. 524 -534.
- De Bruyn, A. and Lilien, G. L. (2008), “A Multi-Stage Model of ‘Word-of-Mouth’ Influence through Viral Marketing”, *International Journal of Research in Marketing*, 25, 3, September, pp. 151 - 163.

De Pelsmacker, P., Geuens, M. and Van den Bergh, J. (2007), *Marketing Communication; a European Perspective*, Essex: Pearson Education.

Divitini, M., Haugalokken, O. K. and Norevik, P. (2002), "Improving Communication Through Mobile Technologies: Which Possibilities?", *Proceedings of the IEEE International Conference on Wireless and Mobile Technologies in Education*, August, Växjö, Sweden, pp. 86 - 90.

Dobele, A., Lindgreen, A., Beverland, M., Vanhamme, J. and van Wijk, R. (2007), "Why Pass on Viral Messages?: Because They Connect Emotionally", *Business Horizons*, 50, 4, July/August, pp. 291 – 304.

Dobele, A., Toleman, D. and Beverland, M. (2005), "Controlled Infection!: Spreading the Brand Message Through Viral Marketing", *Business Horizons*, 48, 2, March/April, pp. 143 – 149.

Farkas, M. (2008), "What Friends Are For", *American Libraries*, 39, 1/2, January/February, p. 36.

Fill, C. (2006), *Simply Marketing Communications*, Harlow: Financial Times Prentice Hall.

Gander, P. (2001), "Mobile Options", *Marketing Week*, 24, 30, September, pp. 41 - 42.

Ghose, S. and Dou, W. 1998. "Interactive Functions and Their Impacts on the Appeal of Internet Presence Sites", *Journal of Advertising Research*, March/April, 38, 2, pp. 29 - 43.

Goh, K. I., Eom, Y. H., Jeong, H., Kahng, B. and Kim, D. (2006), "Structure and Evolution of Online Social Relationships: Heterogeneity in Unrestricted Discussions", *Physical Review*, E 73, 066123, June, pp. 1 - 7.

Goldsmith, R. (2002), *Viral Marketing – Get Your Audience to Do Your Marketing For You*, Essex: Pearson Education Ltd.

Green, J. (2008), "MySpace Politics", *Atlantic Monthly*, 302, 1, July/August, p. 80.

Grinter, R. E., and Elridge, M. A. (2001), "Y do tngrs luv 2 text msg?", *Proceeding of the 7<sup>th</sup> European CSCW Conference*, September, Bonn, Germany, Dordrech, Netherlands: Kluwer Academic Publishers, pp. 219 - 238.

Kennedy, G. E., Judd, T. S., Churchward, A. and Gray, K. (2008), "First year students' experiences with technology: Are they really digital natives?", *Australasian Journal of Educational Technology*, 24(1), January, pp. 108-122

Helm, S. (2000), "Viral Marketing: Establishing Customer Relationship by 'Word-of-Mouse'", *Electronic Market*, 10, 3, pp. 158 - 161.

Hill, S., Provost, F. and Volinsky, C. (2005), "Viral Marketing: Identifying Likely Adopters via Consumer Networks", *CeDER Working Papers*, New York: Stern School of Business.

Howard, T. (2005), "Viral Advertising Spreads Through Marketing Plans", *USA Today*, June 23, 2005, Retrieved 3<sup>rd</sup> June, 2008 from [http://www.usatoday.com/money/advertising/2005-06-22-viral-usat\\_x.htm](http://www.usatoday.com/money/advertising/2005-06-22-viral-usat_x.htm).

- Kaikati, A. M. and Kaikati, J. M. (2004), "Stealth Marketing: How to Reach Consumers Surreptitiously", *California Management Review*, Summer, 46, 4, pp. 6 – 22.
- Lamb, A. and Johnson, L. (2006), "Want to be My "Friend"? What You Need to Know about Social Technologies", *Teacher Librarian*, October, 34, 1, pp. 55 - 57.
- Lampe, C., Ellison, N. and Steinfeld, C. (2007), "A familiar Face(book): Profile Elements as Signals in an Online Social Network", *Proceedings of Conference on Human Factors in Computing Systems*, April/May, San Jose, California, New York: ACM Press, pp. 435 - 444.
- Leskovec, J., Adamic, L. A. and Huberman, B. A. 2007. "The Dynamics of Viral Marketing", *ACM Transactions on the Web*, 1, 1, May, pp. 1 - 39.
- Lindgreen, A. and Vanhamme, J. (2005), "Viral Marketing: The Use of Surprise", In I. Clarke and T. B. Flaherty (Eds.), *Advances in Electronic Marketing*, Hershey, PA: Idea Group Publishing, pp.122 - 138.
- Lindsay, C. (2005), "Viral Statistics", *Caterer and Hotelkeeper*, 194, 4372, April, pp. 41 - 42.
- Milne, G. R. and Gordon, M. E. (1993), "Direct Mail Privacy-Efficiency Trade-Offs Within an Implied Social Contract Framework", *Journal of Public Policy & Marketing*, 12, 2, Autumn, pp. 206 - 216.
- Mohr, I. (2007), "Buzz Marketing for Movies", *Business Horizons*, 50, 5, September/October, pp. 394 - 403.
- Montgomery, A. L. (2001), "Applying Quantitative Marketing Techniques to the Internet", *Interfaces*, 31, 2, March/April, pp. 90 - 108.
- Niederhoffer, K., Mooth, R., Wiesenfeld, D. and Gordon, J. (2007), "The Origin and Impact of CPG New-Product Buzz: Emerging Trends and Implications", *Journal of Advertising Research*, 47, 4, December, pp. 420 - 426.
- Phelps, J. E., Lewis, R., Mobilio, L., Perry, D. and Raman, N. (2004), "Viral marketing or Electronic Word-of-Mouth Advertising: Examining Consumers Responses and Motivation to Pass along Emails", *Journal of Advertising Research*, December, pp. 333 - 348.
- Poore, A. (2007), "Catching the New Wave of the Integrated Marketing Communications Mix: Viral", *Liberty Business Review*, 5, 1, August, pp. 32 - 34.
- Porter, L., and Golan, G. J. (2006), "From Subservient Chickens to Brawny Men: A Comparison of Viral Advertising to Television Advertising", *Journal of Interactive Advertising*, 6, 2, Spring, pp. 30 - 38.
- Subramani, M. R. and Rajagopalan, B. (2003), "Knowledge-Sharing and Influence in Online Social Networks via Viral Marketing", *Communication of ACM*, 46, 12, December, pp. 301 - 307.
- Tumulty, K. (2007), "Obama's Viral marketing Campaign", *Time*, 170, 3, July, pp. 38 - 39.
- Warner, J. (2008), "Seeding a Political Viral Video", *Advertising Age*, 79, 11, March, p. 22.

Welker, C. B. (2002), "The Paradigm of Viral Communication", *Information Services and Use*, 22, 1, January, pp. 3 - 8.

Woerndl, M., Papagiannidis, S., Bourlakis, M. and Li, F. (2008), "Internet-Induced Marketing Techniques: Critical Factors in Viral Marketing Campaigns", *International Journal of Business Science and Applied Management*, 3, 1, pp. 33 - 45.

Subramani, M. R. and Rajagopalan, B. (2003), "Knowledge-Sharing and Influence in Online Social Networks via Viral Marketing", *Communication of ACM*, 46, 12, December, pp. 301 - 307.

Yin, S. (2003), "Degree of Challenge", *American Demographics*, May, pp. 20 - 22.





# Numerical Simulation and Experimental Validation of a Transmission Cable Statistical Fault Identification Method

Ms Caroline Healy, B.Eng, B.Sc.

Dr. Richard A. Guinee, M.IEEE, M.ASCE, M.ΣΕ

Department of Electrical and Electronic Engineering,  
Cork Institute of Technology, Cork, IRELAND  
Richard.Guinee@cit.ie, caroline.healy@mycit.ie

## Abstract

An innovative statistical pulse sequence tester correlation strategy incorporating the deployment of a Pseudorandom Binary Sequence (PRBS) commonly known as a pseudonoise (pN) perturbation is presented as a viable competitive alternative to traditional Time Domain Reflectometry (TDR) for transmission line fault identification and location. The fundamental feature of this system identification application is the generation of a unique characteristic signature, for fault visibility presence, as a consequence of the Cross Correlation (CCR) of the fault induced response echo with the PRBS test input stimulus. The PRBS power spectrum is wideband and white noise like, which enables stimulus injection at very low amplitude levels over several cycles for test purposes with minimal interference to normal online signal traffic. The manifestation of a delayed CCR profile, as the fault syndrome eigenfunction, is due to the impulse response reflection at the fault termination of the spike-like PRBS autocorrelation (ACR) function of the test stimulus. Furthermore the location of the fault can be determined from the inherent 'time lag', as distance through knowledge of the velocity of signal propagation over the transmission link, from the CCR fault signature profile peak value when referenced to the test stimulus ACF peak. PRBS fault identification has additional advantages in that it is capable of online identification of termination irregularities as mismatched impedances other than faults. When cross correlation is undertaken over several cycles, at low amplitude levels, normal online signal traffic and inductively coupled noise pick-up are rejected, as the pN test stimulus is uncorrelated with these, thus enabling multiple fault coverage, resolution and identification. This fault identification technique can in addition be implemented in a diverse range of significant industrial applications including printed circuit boards, overhead transmission lines and underground cables in remote locations. This paper presents a high frequency (~100MHz) co-axial transmission line model for behavioural simulation with PRBS stimulus injection under known load terminations ranging from short circuit (S/C) to open circuit (O/C) to represent fault conditions of a practical nature for test concept validation. The simulated test results demonstrate the accuracy and effectiveness of the PRBS test method, from theoretical considerations, in fault type identification. Model accuracy and fidelity is also substantiated through experimental test results undertaken on a comparable co-axial cable under laboratory controlled conditions for the equivalent cable length and load terminations, which validates the potency of the PRBS diagnostic CCR method for both fault recognition and location. Derived parameter estimates from both experimental testing and simulated model results, of the reflection coefficients and resulting fault termination resistances with Voltage Standing Wave Ratio (VSWR), are in close proximity with theoretical calculations which establish the accuracy of and thus further validate the PRBS test technique.

## Keywords

PRBS testing, fault location, fault terminations, transmission line testing, fault identification.

## 1. Introduction

Security and continuity of supply is an essential prerequisite for all electrical power utility industries and telecommunications service providers in order to guarantee a quality of service (QoS) excellence to any concerned customer clientele base. Continuous online transmission link fault monitoring with early prediction of impending faults and their speedy detection is a key objective to achieve stated QoS targets.

TDR [1,2], which is a mature and well developed technology, has formed the essence of this discipline for many years with the development of high frequency (HF) test and measurement network analysers for a range of HF industrial applications. Unfortunately TDR suffers from a major disadvantage [1,2] as it operates on the principle of a single pulse echo for transmission line fault detection. The pulse amplitude and energy has to be large for long distance fault coverage, which is not possible for online operation without disruption to essential supplies and furthermore may not be in accordance with acceptable national transmission regulations. Thus the single pulse at low amplitude insertion is susceptible to line attenuation with fault distance and phase change distortion with frequency and resolution error upon fault reflection as a result of surplus noise pick-up on the line. The proposed alternative advanced in this paper is the implementation of a bipolar PRBS stimulus strategy, which obviates the need of large test stimulus injection for long distance fault coverage. This stochastic test procedure is a well-known system identification tool [3,4,5] implemented in control systems. It consists of a random time arrangement of low amplitudes pulses with a wideband spectrum [12] resulting in a sustained pulse echo sequence with an accumulated CCR response build-up. This overcomes the problem of uncorrelated link noise, at low pulse energy-to-noise ratio conditions, in fault location measurement. The pulse injection stimulus when cross correlated with the fault response echo over multiple PRBS cycles enables growth of the fault signature above the inherent noise floor by gradually filtering out the noise pick-up and normal signal traffic while in the on-line state. This fault elucidation technique thus produces a unique characteristic signature of the fault syndrome if present which can be both accurately located and identified. As a result of the delta spike-like characteristic of the PRBS ACF function, fault location measurement depends upon the time displacement of the transmission link conditioned PRBS related CCR echo response from the ACF reference peak for accurate fault/load positioning and identification. This measured time delay between correlation peaks can consequently be utilized to establish the propagation delay of the reflected response from the load termination of the unit under test (UUT). Thus this process results in fault/load parameter recognition, reflection transit time from the fault interface and hence the distance of the fault from the reference point of stimulus input can then be determined from knowledge of the link propagation velocity.

In this paper numerical simulation results are presented from a high frequency (HF) co-axial transmission cable model [7] – RG213/U – for PRBS test concept validation. These results demonstrate the effectiveness of the proposed PRBS pulse tester correlation strategy as an accurate and viable alternative to TDR for transmission line fault location and identification that is reinforced from theoretical considerations of the termination impedance mismatch. The results are presented for a co-axial cable of fixed line length and a range of load terminations, known apriori, to simulate realistic fault conditions for a software cable model [7] where the results are then fully collaborated with the corresponding experimental test results thus underlining the operation and authentication of the PRBS pulse tester correlation methodology. Estimated quantities are then derived from these results such as the reflection coefficients, fault termination resistances and VSWR, which are relatively close with the theoretical considerations further confirming the accuracy of the PRBS pulse correlation test technique.

## 2. Overview of TDR and PRBS Fault Diagnosis

TDR is the present de facto standard available for fault finding in power transmission line schemes. TDR operates on the principle of single pulse injection into a cable in the off-line mode whereby the pulse then propagates along the cable until it encounters a faulty termination/load and depending on the severity of the fault all or partial reflection of the pulse energy will occur which then propagates back toward the TDR test device. As the cable is homogeneous the velocity of propagation is regarded as a constant and thus the measured transit time is directly proportional to the fault distance. It can be thus stated that this method operates satisfactorily for faults that occur at close proximity range to the TDR test device. However this process is inconsistent at significant cable lengths as the initial transmitted pulse is increasingly broadened and less focused as the pulse propagates along the line resulting from the presence of phase distortion due to line bandwidth reduction with increased cable length. The TDR technique is also vulnerable to surplus noise pick-up with single pulse attenuation on the link, which suppresses feeble long distant fault reflections [1], thus fundamentally reducing pulse definition essential for precision fault location measurement.

In contrast to TDR, PRBS fault syndrome diagnosis utilises a random cycle of bipolar coded pulses that are reflected at the fault/load termination mismatch as a correlated response accumulation which is extended over the duration of the test sequence. A CCR assessment of the fault response and the incident PRBS test stimulus also incorporating a comparison of the time displayed peak with that of the ACF peak is implemented in isolating the exact fault location. The magnitude and shape of the profile of the CCR echo signal response indicates the type of cable fault present. The presence of link noise can be filtered out gradually over numerous PRBS cycles [4, 5] through a CCR evaluation which effectively magnifies the fault signature significantly out of the uncorrelated inherent noise present, producing an unambiguous characteristic fault profile which can thus be identified and located against the diminishing effect of noise.

### 3. Transmission Line ‘T-Section’ Modelling for Fault Simulation Measurement

In general a co-axial transmission line can be modelled by a lumped parameter ‘T-section’ unit equivalent circuit, as displayed in Fig. 1A at low frequency (LF) [10, 11]. This encompasses a uniformly distributed series inductance  $L$ , resistance  $R$  and a shunt capacitance  $C$  in parallel with a conductance  $G$  over an elemental distance ( $dx$ ). The co-axial transmission link model utilized here for test strategy concept validation is that for a 50 ohm HF cable shown in Fig.1B, which has a nominal distributed capacitance  $C = 100$  pF/m and inductance of  $0.25\mu\text{H/m}$ , using a PSpice simulator [7]. The characteristic impedance  $Z_0$  and complex propagation coefficient  $\gamma$  of the model can be determined as [8].

$$Z_0 = \sqrt{\frac{(R+j\omega L)}{(G+j\omega C)}} \tag{1}$$

$$\gamma = \sqrt{(R+j\omega L)(G+j\omega C)} = \alpha + j\beta \tag{2}$$

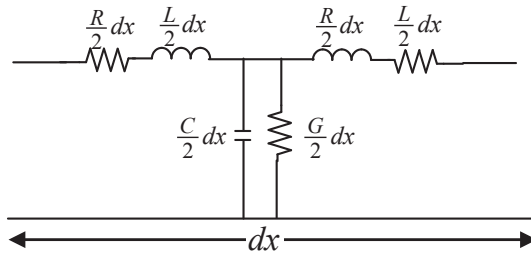


Figure 1: Full Model Lumped Parameter ‘T-Section’

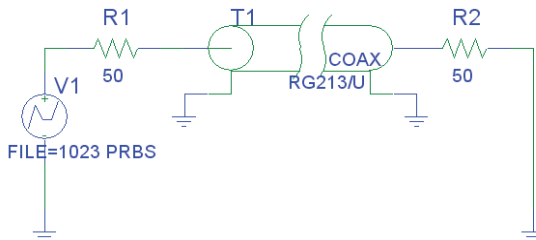


Figure 2: PSpice Co-axial Cable Model

The equivalent ‘T-Section’ can be further simplified for transmission line operation at high frequency  $\omega$  with the omission of the distributed resistance  $R$  and conductance  $G$  in accordance with condition [8],

$$\omega L \gg R \ \& \ \omega C \gg G \tag{3}$$

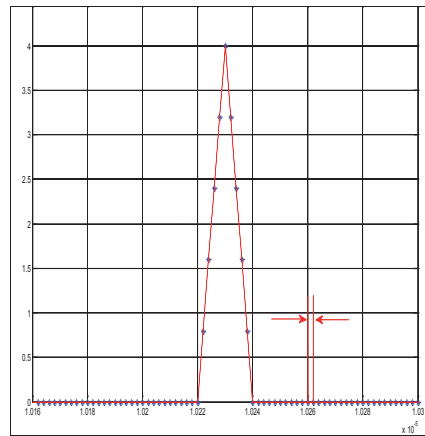
The resultant propagation velocity can be determined from the line frequency  $\omega$  and phase-change coefficient  $\beta$  as

$$v_p = f \cdot (2\pi/\beta) = (\omega/\beta) \quad (4)$$

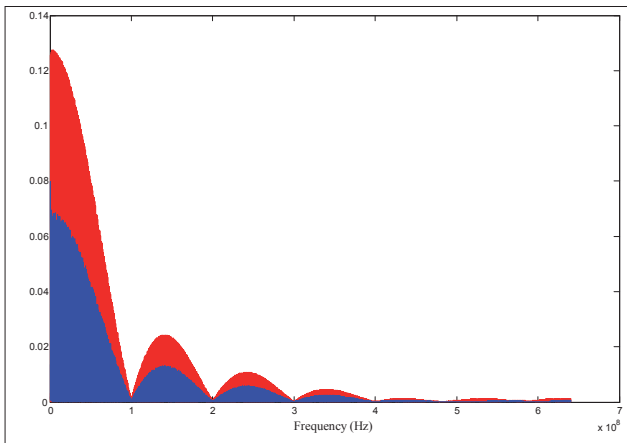
For a HF ‘lossless line’ operation in (3), with a corresponding attenuation coefficient  $\alpha = 0$ , the characteristic impedance  $Z_0$  and propagation coefficient  $\gamma$  can be resolved respectively as

$$Z_0 = \sqrt{\frac{L}{C}} \quad (5)$$

$$\gamma = j\beta = j\omega\sqrt{LC} \quad (6)$$



**Figure 3: 1023 PRBS Autocorrelation Function (ACF)**



**Figure 4: PRBS and O/C Reflection Spectra**

If, for example, a 150m HF RG213/U Co-Axial Cable based on the pSpice model [7] with  $Z_0 = 50\Omega$  is simulated for open circuit conditions with a PRBS input at 100MHz the PRBS ACR along with the FFT of the combined pN stimulus and fault reflection at the cable input are shown in Figs.2A & 2B respectively.

#### 4. Transmission Line Testing Using PRBS

PRBS stimuli  $X(t)$ , when employed in transmission line testing, change logic state pseudo randomly between voltages  $+V$  and  $-V$  at discrete time interval  $\Delta t$ . The bipolar test signal is generated from a specially configured  $n$  stage linear feedback shift register [6,10] and has a maximum sequence length  $L = (2^n - 1)$  with period  $T = L\Delta t$ . The pseudo noise (pN) stimulus has a unique delta function like ACF defined for a time step shift  $\tau = k\Delta t$  over one period  $T$  with  $0 \leq k \leq (L-1)$ , as shown in Fig.2A, by

$$R_{xx}(k) = \frac{1}{L} \sum_{j=1}^L x(j)x(j+k) = \begin{cases} +V^2 & \text{for } k=0 \\ -V^2/L & \text{for } k \neq 0 \end{cases} \quad (7)$$

The PRBS ACF along with the CCR fault response is used to determine the transit delay  $\tau_l$  and thus the fault distance  $l$  of the transmission line from a knowledge of the propagation velocity  $v_p$ .

#### 5. Fault Finding and Identification with Pseudo Noise Sequences

In the event of a mismatch occurring at the load termination with  $Z_L \neq Z_0$ , a reflection  $Y(t)$  will be present at any point along the line with the incident wave  $X(t)$ . The extreme worst case scenarios of a fault mismatch arise for (i) a short circuit fault with  $Z_L = 0$ , and (ii) an open circuit fault with  $Z_L = \infty$ . Aside from these well recognized line faults other forms of partial line discontinuities produce reflections as a result of [1] joints, splits and waterlogged zones, all of which can be characterised as minor mismatches. The extent of the reflection occurring at the load terminal  $Z_L \neq Z_0$ , can be established from the incident wave by the reflection coefficient  $\rho$  [11] as

$$\rho = \frac{Z_L - Z_0}{Z_L + Z_0} \quad (8)$$

The resulting voltage standing wave ratio (VSWR)  $s$ , which is a measure of the amount of line reflection present, is determined from  $\rho$ , with  $-1 \leq \rho \leq 1$ , as

$$s = \frac{1+|\rho|}{1-|\rho|} \quad (9)$$

Four common cases of line termination arise to influence the values of  $\rho$  and  $s$  [8,9] that will provide an indication of the line type fault present:

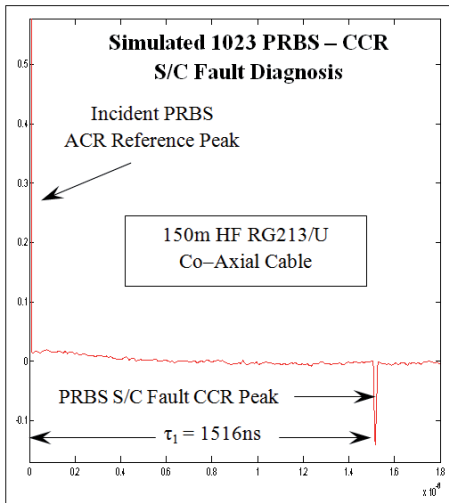
- (i) Matched load conditions with  $Z_L = Z_0$  and no reflection with  $\rho = 0$  and  $s = 1$ .
- (ii) Open circuit line  $Z_L = \infty$  where complete incident wave reflection occurs without phase reversal  $\rho = 1$  as in Fig 4.
- (iii) Short circuit line  $Z_L = 0$ , thus complete incident wave reflection occurs with phase reversal  $\rho = -1$  as Fig 3.
- (iv) Mismatched termination  $Z_L \neq Z_0$  causing incident wave reflection occurrence with or without phase reversal depending on the relative size of  $Z_L$  and  $Z_0$ ,

(1) If  $Z_L < Z_0 \Rightarrow \rho < 0$  and  $s = Z_0 / Z_L$ .

(2) If  $Z_L > Z_0 \Rightarrow \rho > 0$  and  $s = Z_L / Z_0$ .

The phase relationship between both the reflection echo response and the incident PRBS can be determined through  $\rho$  in the PRBS – CCR process along with the VSWR indicating the type of load termination present. For PRBS  $X(t) = \{x(1), x(2), \dots, x(L)\}$  injected into a faulty line a conditioned echo response will result as  $Y(t) = \{y(1), y(2), \dots, y(L)\}$  which can then be cross correlated with the incident disturbance  $X(t)$  as

$$R_{xy}(k) = \frac{1}{L} \sum_{i=1}^L x(i)y(i+k) \quad (10)$$



**Fig. 3A: Simulated S/C Line CCR Signature**

to yield a characteristic CCR line fault signature. The CCR process yields a correlation peak at some shift time  $\tau_1$  relative to the PRBS ACR as per Fig 3A. For a

short circuit line fault an inverted phase shifted CCR profile occurs which is indicative of the line fault distance  $l$  from the test stimulus input  $X(t)$ . The time displacement  $\tau_l$  of CCR peak is measured from incident PRBS reference ACR peak as per Fig 3. When  $\tau_l$  is divided by two and multiplied by the line propagation velocity  $v_p$  the fault distance  $l$  to the source of reflection can be determined as

$$l = v_p \cdot \tau_l / 2 \tag{11}$$

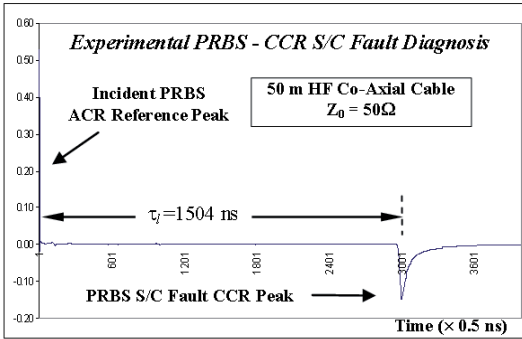


Fig. 3B: Experimentally derived S/C Fault Signature

### 6. Simulated HF Line & Fault Diagnosis

A 150m HF co-axial line model was simulated using ‘pSpice’ software in accordance with (3) producing a ‘lossless line’ with  $\alpha = 0$ . The Nexans RG213/U cable model was chosen to comply with the experimental co-axial cable technical specifications with a characteristic impedance  $Z_0 = 50 \Omega$ , capacitance  $C = 100 \text{ pF/m}$  and the velocity of propagation determined as

$$v_p = \frac{1}{\sqrt{LC}} = \frac{1}{Z_0 C} = \frac{1}{(50)(100 \times 10^{-12})} = 2 \times 10^8 \text{ m/s} \tag{12}$$

A 1023 bit, 4 volt peak-to-peak bipolar (-2V to +2V) amplitude PRBS was utilised as a test stimulus input (I/P) with a 10 ns bit duration coinciding with the specified co-axial cable operational frequency of 100 MHz. With a 10 ns PRBS bit duration, with  $\Delta t = 10 \text{ ns}$ , and a known line velocity  $v_p = 2 \times 10^8 \text{ m/s}$  the fault distance can be resolved to an accuracy  $\Delta d$  given by  $\Delta d = (v_p \text{ m/s})(\Delta t) = 2 \text{ meters}$ .

### 7. Simulated Co-Axial Model Test Results

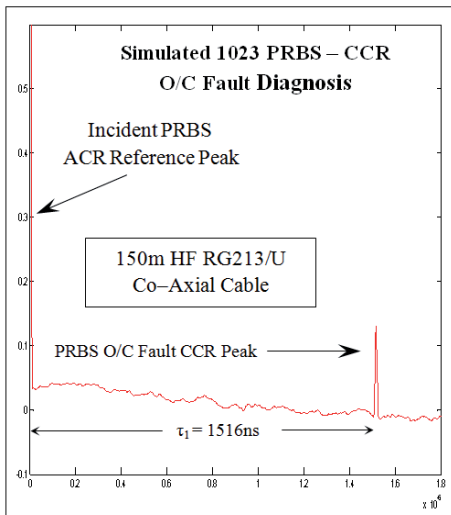
The 150m co-axial cable was initially simulated for an O/C line fault in which case the incident PRBS stimulus is reflected from the fault termination back to the source without phase reversal. When the combined incident and reflected elements are cross correlated together with the incident PRBS the resultant non inverted CCR peak indicates presence of an O/C fault ‘echo’ via (10) as the line fault signature along with the reference ACF in Fig. 4A. The relative time displacement  $\tau_l = 1516 \text{ ns}$  of



the CCR and ACF peaks results in the propagation delay from the PRBS stimulus to transverse the line from the input to the fault and back with a total distance coverage  $2l$ . The measured ACF-CCR peak displacement  $\tau_l$  in Fig. 4A along with the known phase velocity  $v_p$  in (12) provides an accurate estimate of the fault location  $\hat{l}$  and its type via the reflection coefficient as

$$\hat{l} = (\tau_l/2) * v_p = (1516\text{ns}/2) * 2 \times 10^8 = 151.6 \text{ m}$$

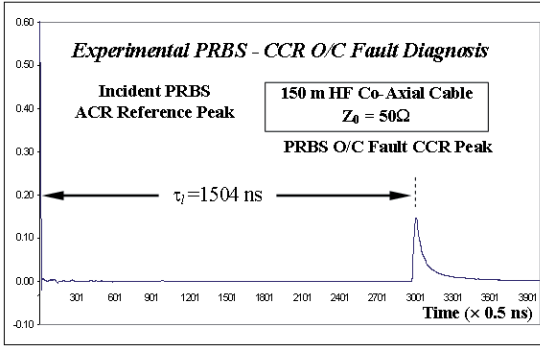
Hence knowledge of the CCR peak displacement  $\tau_l$  and link propagation velocity  $v_p$  is all that is required for an accurate estimation of the fault location. Alternatively when the 150 m HF line is short circuited (S/C) the pN input test stimulus will experience a phase reversal upon reflection as evidenced by the negative CCR echo response in Fig.3A. Again it can be observed by calculation that the relative time displacement  $\tau_l = 1516 \text{ ns}$  of the ACF and CCR peaks provide an accurate estimation  $\hat{l}$  of the ‘known’ fault location  $l$ , which is identical to the identified O/C position in Fig. 4A.



**Fig. 4A: Simulated O/C Line CCR Signature**

The 150 m co-axial line was also additionally simulated at various resistive fault terminations in  $10\Omega$  steps from  $10\Omega$  to  $100\Omega$  and thereafter in  $100\Omega$  steps with little observed difference from O/C conditions as shown in Fig. 5 which further validates the accuracy of the pN – CCR method. Each CCR peak occurs at the same time shift in Fig. 5 due to the impedance faults which were all simulated at the same distance away from the PRBS source excitation at  $l = 150 \text{ m}$ . The importance of the CCR fault observations in Figs. 3A and 4A is the existence of correlated echo peaks and their polarity which provides an indication of the type of line fault present. Initially the observation of whether or not a CCR peak is present should be made with the decision that if no CCR peak occurs then there is no occurrence of a mismatch/ fault

on the line and  $Z_L = Z_0$ . However if  $Z_L > Z_0$  a positive peak is evident and a possible O/C or high impedance fault exists on the line as seen in Fig 5.



**Fig. 4B: Experimentally derived O/C Fault Signature**

Alternatively if  $Z_L < Z_0$  then a negative peak is observed indicating a possible S/C or low impedance fault existing on the line as in Fig 5. It can be observed that the CCR peak magnitude varies with  $Z_L$  and the degree of mismatch occurring with  $Z_0$  in terms of the reflection coefficient  $\rho$  in (9) is proportionally passed to the correlation peaks. If fault or load resistance  $R_L$  terminations ( $R_{L1}, R_{L2}$ )  $> Z_0$  are utilized for example with  $R_{L1} > R_{L2}$  then the polarities of the CCR peaks are positive in both occurrences. Also a comparison of the CCR peak amplitudes illustrate increasing CCR values with fault termination  $R_L$ , as per Fig. 5, resulting in increased reflection echo coefficient  $\rho$ , that is,

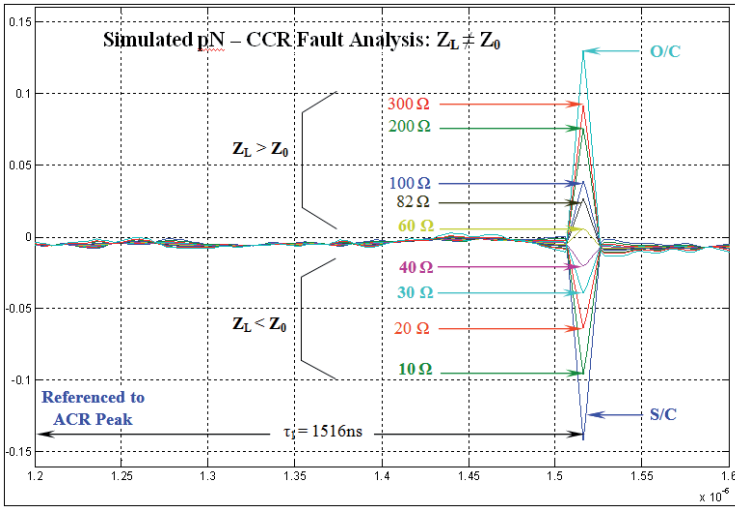
$$\max R_{xy}|_{R_{L2}} > \max R_{xy}|_{R_{L1}} \text{ for } R_{L2} > R_{L1}. \tag{13}$$

Similar conclusions prevail for the converse case in Fig. 5, which depicts a negative polarity with  $R_L < Z_0$  and increased absolute CCR value with reduced fault resistance termination. PRBS fault diagnosis can also be used to estimate the reflection coefficient  $\rho$  for a ‘lossless’ line for a given  $R_L$  as,

$$\hat{\rho} = \frac{\max R_{xy}|_{CCR}}{\max R_{xx}|_{ACR}} \tag{14}$$

from a ratio comparison of the ‘reflected’ CCR to the incident ACF peaks in (14) for each of the resistive fault cases  $R_L$  in Fig. 5. However for a co-axial cable with finite losses in this case the reflection coefficient estimate shown in Fig.6A is determined from an a priori knowledge of the O/C or S/C CCR value as,

$$\hat{\rho} = \frac{\max R_{xy}|_{CCR}}{\max R_{xy}|_{CCR-O/C}} = \frac{\max R_{xy}|_{CCR}}{\max R_{xy}|_{CCR-S/C}} \tag{14A}$$



**Fig. 5: Simulated ACR and CCR Fault Responses for Termination Conditions  $Z_L \neq Z_0$**

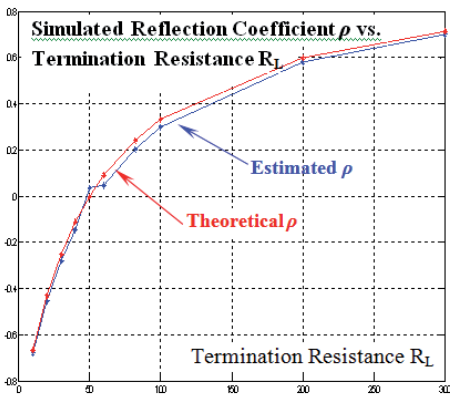
This information can then be used to estimate the actual resistive fault manifestation  $R_L$  from the expression,

$$\hat{R}_L = \frac{(1+\hat{\rho})}{(1-\hat{\rho})} Z_0 \quad (15)$$

and the VSWR  $s$ , from (9), as,

$$\hat{s} = \frac{1+|\hat{\rho}|}{1-|\hat{\rho}|} \quad (16)$$

shown in Figs. 7A and 8A respectively.



**Fig. 6A: Simulated Reflection Coefficient Estimates**

Comparison of the derived fault resistance  $\hat{R}_L$  and VSWR  $\hat{s}$  estimates from the simulated reflection coefficients  $\hat{\rho}$  in Fig. 6A, with the known resistive terminations  $R_L$  used in the simulated model and theoretical VSWR values illustrate a good correlation when plotted in Figs. 7A and 8A. The accuracy of these derived quantities further enhances confidence in the PRBS fault diagnostic method and confirms its capability in fault resistance identification.

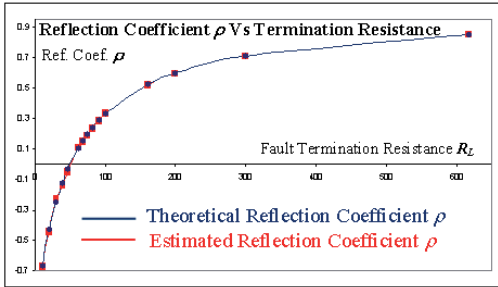


Fig.6B: Reflection Coefficient Experimental Estimates

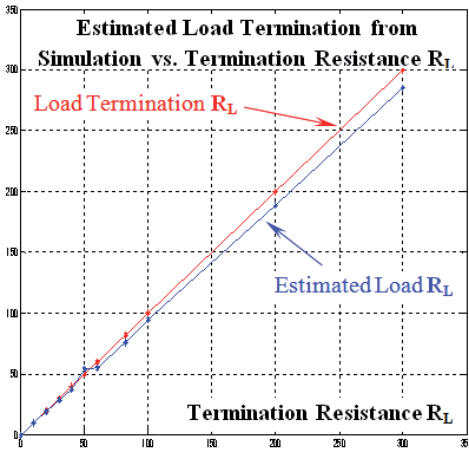


Fig. 7A: Plot of Simulated Load Termination Estimates

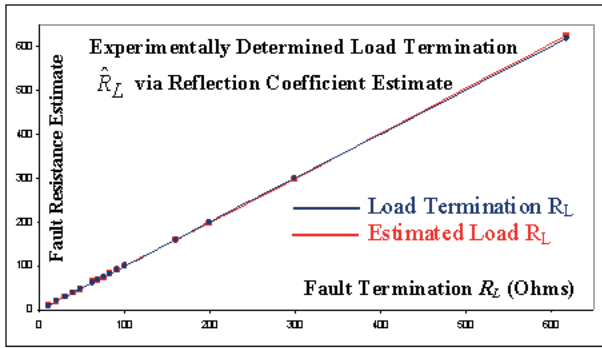


Fig.7B: Plot of Experimental Load Termination Estimates

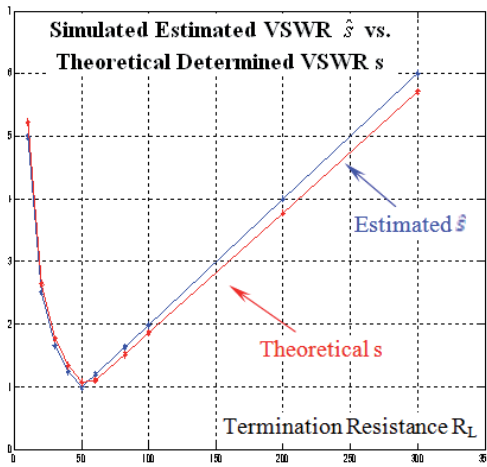


Fig. 8A: Simulated VSWR Estimates

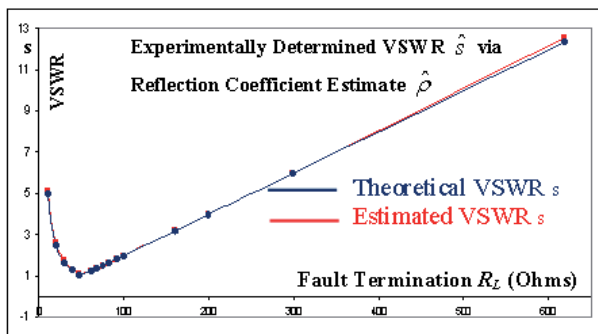


Fig. 8B: Experimental VSWR Estimates

## 8. Experimental HF Coaxial Line Fault Diagnosis

A nominal 500 m drum of URM-43 HF co-axial cable with  $Z_0 = 50 \Omega$  and distributed capacitance  $C = 100 \text{ pF/m}$  was cut to a length of 150 m with a drum residue of 350 m (Guinee, 2008). This cable length was then subjected to a pN injection excitation under laboratory controlled conditions for various ‘known’ discontinuities, with the intention of validating experimentally both the fault location and identification capability of the PRBS – CCR technique. Assuming a ‘lossless’ HF line behaviour as in (3), at the pN test frequency of a 100 MHz, the distributed inductance ( $L$ ) can be derived for fault location estimation during test as  $L = CZ_0^2 = 0.25 \mu\text{H/m}$  along with the line propagation velocity as (12)  $v_p = 2 \times 10^8 \text{ m/s}$ . Thus this value of  $v_p$  can be utilized with the echo fault response transit time, back to the line input test stimulus, to determine the fault location as per (11).

### PRBS Stimulus Characteristics and Fault Distance Resolution

To coincide with the simulated input PRBS test stimulus, a 4 volt amplitude, 1023 bit PRBS input excitation was utilised as an injected test stimulus with a 10 ns bit duration  $\Delta t$ . Thus the selected  $\Delta t$  corresponds to the co-axial cable specified operational frequency of 100 MHz and also within the test pattern generator (TPG) limits. Implementing a bit duration of  $\Delta t = 10 \text{ ns}$  with a line velocity  $v_p = 2 \times 10^8 \text{ m/s}$ , the fault distance can be resolved down to an accuracy  $\Delta d$  given by  $\Delta d = (v_p)(\Delta t) = 2 \text{ m}$ . An 8-channel Agilent mixed storage oscilloscope with a 2 GHz sampling frequency was utilized at the line input end in order to capture data of the input stimulus as well as the delayed fault echo response for subsequent post test data analysis and cross correlation signal processing. The higher sampling frequency results in an improved fault distance resolution accuracy of  $\Delta l = v_p \Delta t / 20 = 0.1 \text{ m}$ .

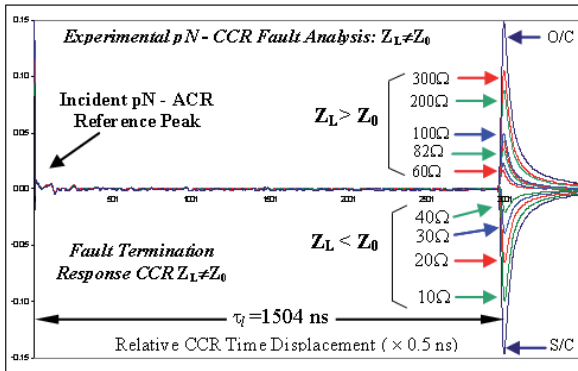
### Experimental Co-Axial Cable Test Results

Initially the 150 m cable length was terminated for s/c and o/c conditions to gauge the accuracy of the PRBS - CCR method of fault identification and location as shown in Fig. 3B and 4B respectively. Thus the location  $l$  of the O/C and S/C terminations is determined from the displacement  $\tau_l = 1504 \text{ ns}$  of the CCR fault response from the ACF reference peak via (11) as  $l = (2 \times 10^8 \text{ m/s}) (1505 \times 10^{-9} \text{ s}) / 2 = 150.5 \text{ m}$  which is equivalent to the subsequent physical length of the cable. Additional line testing was then undertaken with ‘known’ resistive fault terminations of  $Z_L \neq Z_0$ , in  $10 \Omega$  steps beginning at  $10 \Omega$  up to  $100 \Omega$  and thereafter in  $100 \Omega$  steps as per Fig. 9, little observed difference from O/C conditions, which provides further validation in terms of accuracy of this trouble-shooting technique for fault identification.

As previously observed for the cable fault simulation results with the occurrence of a mismatch, the polarity of the characteristic syndrome signature in the experimental test fault cases will identify the nature of the fault present. If the polarity is positive then this indicates an O/C or high impedance fault and if it is negative this indicates the presence of a S/C or low impedance fault as in seen in Fig. 9.

Again in validating experimentally determined results, the reflection coefficient estimates shown in Fig.6B, which are closely correlated with the plotted theoretical

values, can be used as per (15) to estimate the load termination values shown in Fig. 7B and the VSWR values in Fig. 8B via (16). Comparison of the derived termination resistances, known apriori, and VSWR estimates from the experimentally obtained reflection coefficients in Fig. 6B show excellent agreement with theoretical values in both cases in Figs 7B and 8B respectively. The accuracy of these derived quantities further reinforces confidence in PRBS fault diagnostic method.



**Fig. 9: Experimentally Determined ACR and CCR Fault Responses for Termination Conditions  $Z_L \neq Z_0$**

## 9. Conclusions

In this paper a novel pN strategy for fault tracing and identification on HF co-axial transmission lines has been presented. Concept validation has been extensively provided both experimentally, via laboratory controlled testing, and through simulation via PSpice of a variety of fault termination scenarios. Derived quantities from simulation and experimental testing of fault distance and reflection coefficients were then subjected to analysis in deriving resultant estimates of termination mismatches, known apriori, and VSWR values with comparison to theoretically derived measures to gauge and verify the accuracy of the PRBS test strategy as a competitive alternative to the industrial TDR standard. Model simulation and experimental test results are in good agreement with theoretically derived quantities. The analysis incorporated a HF co-axial transmission link of a fixed line length of 150m for a range of fault impedance terminations ranging from open circuit to short circuit types for authentication of the PRBS pulse tester correlation methodology. Additional confidence enhancement of the method has been provided by the success in the identification of a range of mismatched fault impedances. In conclusion the PRBS fault identification strategy can be implemented to determine the nature/type of fault, its precise location and magnitude along with the reflection coefficient and VSWR on a transmission line for mixed signal transport.

## 10. References

- Clegg, B. (1993), *Underground Cable Fault Location*, London, McGraw Hill.
- Agilent Technologies Web Site (2002) - Application Note 1304-2, <http://www.agilent.com>. (Accessed 03 October 2010)
- Gill, K.F and Schwartzbach, J. (1992), *System Modelling and Control*, London, Arnold Publishers.
- Godfrey, K. (1993), *Perturbation Signals for system Identification*, New York, PHI.
- Guinee, R.A, (2000), "Variable Speed Motor Drive Testing and Parameter Identification using Pseudorandom Binary Sequences", *IEEE Melecon Electrotechnical Conference*, Cyprus, 29 – 31 May, 2000, 1085 - 1088 vol.3.
- Guinee, R.A and Horan, D.M. (2005) "A Novel Pulse Echo Correlation Tool for transmission Path Testing and Fault Finding using Pseudorandom Binary Sequences", *IEEE International Symposium on defect and fault Tolerance in VLSI Systems Conference*, California, 03-05 October, 2005, pp. 229 – 237.
- Microsim pSpice (1997), *Circuit Analysis Software*, Microsim Corp.Ver.8.0, June 1997.
- Fraser, W. (1978), *Telecommunications*, London, Macdonald and Jane's Publishers.
- Connor, F.R. (1972), *Waves*, Great Britain, Arnold publishers.
- Hartley, M.G. (1975), *Digital Simulation Method*, England, Peter Peregrinus Ltd.
- Guinee, R.A. (2008), "A Novel Pulse Echo Correlation Tester for transmission Path Testing and Fault Finding using Pseudorandom Binary Sequences", *IEEE - Industrial Electronics Conference*, Orlando, Florida, 10 – 13 November, 2008, pp. 1833 - 1838.
- Cooper, G.R. and McGillem, C.D. (1986), *Modern Communications and Spread Spectrum*, New York, McGraw Hill.



# Design and Development of Embeddable Wireless Sensors for Concrete Curing and Structural Health

William Quinn<sup>1</sup>, Philip Angove<sup>3</sup>, John Buckley<sup>3</sup>, Dr. Ger Kelly<sup>1</sup>, Dr. John Barrett<sup>2</sup>  
<sup>1</sup>Department of Mechanical and Process Engineering & <sup>2</sup>Department of Electronic Engineering, Cork Institute of Technology, Ireland  
Tyndall National Institute, Cork, Ireland  
e-mail: william.quinn@cit.ie

## Abstract

This paper describes the design and development of an embeddable wireless sensor for monitoring the condition of concrete. An embeddable sensing platform was designed and tested and results show that the 433MHz ISM band is suitable for such a system. An extensive test bed was developed which recreated expected construction site conditions. The presence of steel backed formwork and reinforced concrete was shown to reduce the transmission distance of the embedded sensors to 3.5m which extended to over 5m when the formwork was removed. A verification experiment also showed that the depth at which the sensor is placed also had a significant effect on the transmission success. A second monitoring approach based on embedding a piezoceramic into concrete and employing the electromechanical impedance (EMI) method is described. The EMI method is advanced to allow it to be embedded into the concrete from first pour. This is achieved by designing a package for the sensor which does not introduce a significant structural discontinuity into the concrete. To enable the piezoceramic to be used on the designed wireless sensing platform the feasibility of using the AD5933 impedance chip from Analog Devices is examined. The piezoceramic sensor is designed to ensure that it is compatible with the aforementioned chip. The sensing system was embedded into a concrete at first pour and, using the resonant/antiresonant frequency shift index, the strength development of the concrete was monitored as it cured. This was compared with the compressive strength development. The concrete was then tested in a hydraulic compression tester and the response of the sensor was monitored to verify if it could be used to measure concrete in-service stresses. Results of the testing procedures show that monitoring the imaginary resonant frequency shift can provide important information during both early stages of the concrete's development and also during its service life.

## Keywords

Structural Health Monitoring, Concrete, wireless embedded sensing platform, Electromechanical Impedance Method

## 1. Introduction

The growing importance of structural health monitoring is evident in the number of smart structures being created around the world. Two examples of this trend are the Wind and Structural Health Monitoring (WASHM) in the Tsing Ma suspension bridge in Hong Kong and the system in the recently built 1-35W Saint Anthony Falls Bridge in Minneapolis which contain over 350 and 300 sensors respectively. The use of embedded sensors in the monitoring of concrete has received increased interest in

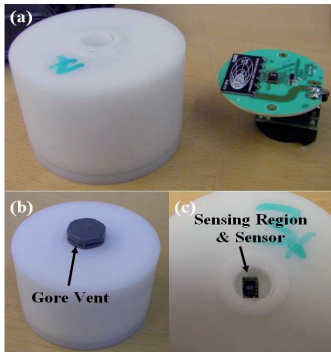
recent years. These sensors can be wired (Grasley, Lange et al. 2006), wireless (Saafi and Romine 2004) or a hybrid (Sokoll and Jacob 2007) of the two. Wireless sensors have the potential to reduce the complexity and cost of sensing systems as the requirement of wiring the systems to an external data acquisition system can be eliminated. A sensor which monitors the hydration process and subsequent health would yield information on the instantaneous condition of the concrete, allowing reduced construction times and operational and maintenance costs. A system capable of monitoring the curing of concrete and its long term resilience can ensure that the durability of a structure achieves its design requirements.

This paper reports on an embedded wireless sensor for monitoring concrete curing and structural health and is broken into two sections. Section A focuses on the design and testing of an embeddable wireless sensing platform. Section B introduces tests using the Electro Mechanical Impedance (EMI) method for monitoring concrete strength development and deterioration. The method is adapted and enhanced so that it can be incorporated into the wireless sensing node. This is achieved through the incorporation of the AD5933 impedance chip from Analog Devices.

## **2. Section A: Development of a Wireless Sensor Node**

The developed wireless sensor prototype in this research was designed using the Tyndall 25mm mote (Flynn, Lynch et al. 2006). When designing a wireless system it is essential that the correct transmission frequency is selected as it not only affects the transmission characteristics but also the size of the transmitting and receiving antennas. This is an important consideration as when the sensor is embedded the antenna is the main factor which determines the overall size of the system. Limited work has been undertaken into the examination of embedded sensors embedded at depth within concrete. Passively powered sensors have been developed but these systems require the interrogator and the sensor to be within close proximity to one another (Andringa, Puryear et al. 2007; Wu and Wu 2009) which is a limitation when attempting to design large scale automated sensing systems. The lack of research into wireless systems embedded in concrete led to an investigation of wireless systems in other fields to aid in the selection of the most suitable transmission frequency. These included wireless underground soil, ice pack, volcanic, and mine monitoring systems. Porret et al (Porret, Melly et al. 2000) stated that the use of ISM (Industrial, Scientific and Medical) frequency bands are preferred as they are not bound to any particular standard. Analysis of these systems and the available ISM bands resulted in the selection of the 433 MHz frequency band. As mentioned the size of the antenna determines the overall size of the packaged sensor. The work of Bernhard (Bernhard, Hietpas et al. 2003) and Jin (Jin and Ali 2010) indicated that a patch antenna can be used to significantly reduce the overall size of the transmission system. It was decided to incorporate the SPLATCH 433 SP2 50 $\Omega$  grounded line planar antenna which would allow the minimisation of the sensor and package system. During feasibility testing procedures the SHT11 sensor (SHT11 Datasheet 2008 ) was applied to the wireless platform to determine if measurement using an embedded sensor was possible. The prototype sensor is powered by batteries with further research into powering methods e.g. electromagnetic coupling, power harvesting to be performed.

## 2.1. Package Design & Calibration of Sensor Node



**Figure 1: Sensor and Pack**

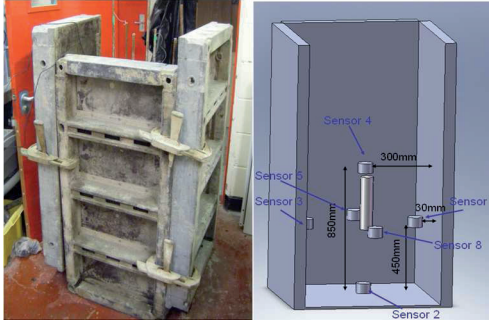
A protective package was designed to protect the sensor and its circuitry from the aggressive conditions within concrete. The work of Shams (Shams, Ali et al. 2006; Shams, Miah et al. 2007) found that when embedded in concrete that an air-gap between the antenna and the concrete is required. Using the 2.45 GHz frequency band the best response was found with an air gap of 5 mm and above. As this project was using a longer wavelength it was decided to design the package with an air-gap of 10 mm. A Gore screw in protective vent (Gore Membrane Vents) was incorporated into the package to

expose the SHT11 sensor to the conditions within the concrete while protecting it from the alkaline environment within concrete. Figure 1 shows the final sensor and package assembly. The suitability of the vent was investigated by placing it into a solution of pH 13 over a 72 hour period. A magnified image of the structure of the vent's membrane was taken using a Hitachi S3700 Scanning Electron Microscope before and after immersing the membrane within the solution. The results indicated that the highly alkaline nature of the pore water would have negligible effect on the transmission properties of the Gore material.

The response of the sensor and package combination was tested within a humidity chamber (Votsch HC7033). The tests were designed to replicate the actual expected humidity of concrete as it cures. It was found that after 3 hours the designed sensor comes within 3% relative humidity (RH) of the RH of the chamber. This occurs consistently and the sensor takes less than one hour to fall within 4% RH of the reading of the chamber. The sensor was found to be most accurate and had the quickest response time in the RH 60%-90% range. This is essential for monitoring the curing process due to the fact that in the range 60 – 80 %RH hydration is minimal and below 60% RH is believed to stop completely (Molina 1992; Pentz 1994). The response was therefore concluded to be suitable for the purposes of this paper as the hydration of concrete proceeds relatively slowly.

## 2.2. Feasibility of embedding a wireless sensor into concrete

In each experiment in this paper concrete was made from Ordinary Portland cement, fine aggregate, coarse aggregate and water. A water cement ratio of 0.53 was chosen to ensure a minimum compressive strength of 25 N/mm<sup>2</sup>. LabVIEW programs were designed to communicate with the equipment and to record experimental data. A mould was designed using steel backed formwork and filled with reinforced concrete to the dimensions 600mm x 600mm x 900mm (L x W x H). The formwork was removed after 10 days. The sensor deployment was designed so as to be able to determine the accuracy and sensitivity of the SHT11 humidity and temperature sensor. In each sensor the SPLATCH 433 SP2 50Ω grounded line planar antenna was used to reduce the overall size of the sensor. In this experiment the top surface

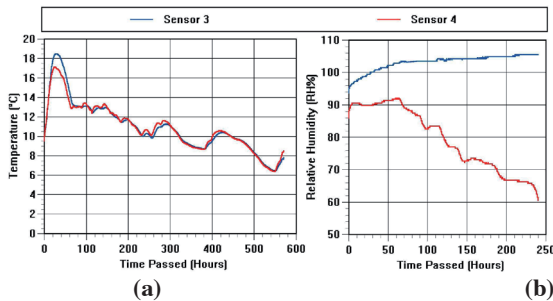


**Figure 2 Experimental Setup and location of sensors**

was left exposed to test the sensitivity of sensor 4 which was placed below the exposed face of the concrete. This would result in different moisture and RH in this area as heat and moisture would be able to dissipate to the surroundings and result in lower readings. Figure 2 shows the final construction and the location of each of the sensors relative to the formwork. In the centre a monopole antenna transmitter was placed to compare

transmission success with that of the SPLATCH antenna. To determine the accuracy of the temperature sensor on the SHT11 sensor thermocouples were placed in the concrete with the sensors. The receiver was located 1.5 m from the specimen.

### 2.3. Results and discussion



**Figure 3 (a) temperature profile & (b) RH profile of concrete as hydration**

To examine the ability of the system to transmit readings, the SHT11 sensor was incorporated into the sensor node. Figure 3 (a) shows the temperature profile of the sensors embedded within the concrete. It can be seen that the maximum temperature of sensor 4 was lower than that of the others. This was due to the fact that sensor 4 was located at the top of the sample. The temperature profile corresponds with the expected temperature in concrete with a peak in the first 30 hours. The sensors agreed to within 1% of the readings of the thermocouples placed alongside the sensors. The sensor which read the temperature and RH every 5 minutes lasted over 24 days. This indicates that power conservation algorithms combined with power harvesting may allow for complete monitoring of a structure. The RH was expected to reach a maximum when placed inside the concrete and to reduce over time as the concrete cured. All 6 sensors followed the expected response over the first few hours. Figure 3 (b) shows how the sensors reached above 95% humidity over the first 3 hours. Sensor 4 reaches a level of 90%. It was expected that sensor 4 would have a lower reading due to the fact that it was located on the exposed side of the concrete. The RH remained around 90 – 92 RH% until 72 hours had passed and then started to reduce significantly. Over the following 170 hours the concrete dried to 65%RH.

Over this time the rate of change of the RH was 0.15%RH/hr. This meant that the rate of curing reduced to a minimum and most likely came to a halt at the top of the specimen. After 10 days the sensor ceased to read RH from sensor 4 but continued to read temperature. Sensors 2, 3, 5, 7, and 8 did not read RH as expected. The recorded humidity rose to 100% after 30 hours and it is believed that condensation occurred within the sensing region and caused the sensor to read a value above 100% for the remainder of the experiment. These results show that an indirect measurement of RH using the SHT11 may not be the most suitable method of monitoring the conditions of the concrete. Section B introduces an alternative method of monitoring hydration.

The transmission distance of the embedded sensor was also investigated. It was found that when the sensor was embedded within the concrete and behind the formwork the transmission distance was approximately 3.5 m which extended to 5 m when the formwork was removed. In a further test when the sensor was embedded in the centre of a similar test bed the transmission distance was reduced to 1m in the early stages which indicates that when the concrete is wet it has a large influence on the transmission distance. Further research has verified this. The reinforcement mesh density was also found to have a significant effect on the transmission distance.

### **3. Section B: Advancement of the EMI technique**

The experience gained in using the humidity sensor indicated that it may not be the best approach for long term monitoring of concrete. This is due to two reasons – the use of the humidity sensor increases the complexity of any designed package, and while useful in the early stages humidity may not offer a good indication of the performance of the structure during its service life. An examination of the current technologies indicates that the electromechanical impedance (EMI) technique is most suitable for application to a wireless sensing platform, especially with the existence of the AD5933 impedance chip. The EMI method has not been successfully advanced to allow it to be used in an embedded situation and this section of the thesis describes the steps taken in advancing the method for such a purpose.

#### **3.1. The EMI Method**

The EMI method incorporates the piezoelectric effect to monitor changes in the condition of the structure to which it is bonded. The piezoelectric material produces a mechanical strain when an electric field is applied, which is known as the piezoelectric effect. Piezoelectric materials also show what is termed the inverse piezoelectric effect whereby an induced strain produces an electric field. The EMI method uses both the direct and inverse effect in synergy where an electric current is applied causing a deformation but when loaded the induced stress causes an electric current to be produced in the material. This effect can be measured using an impedance analyser. The benefit of the piezoelectric method is that the actuator and sensor are located on one system which reduces the number of components in the system and the amount of wiring required. Other benefits include being lightweight, robust, and inexpensive. For sensing purposes advantages include quick response, high linearity, wide frequency ranges, and low power consumption (Park 2003). It has been found that the electrical impedance of the piezoelectric material can be directly related to

the mechanical impedance of the host structure (Bhalla and Soh 2004). The EMI method has been applied to composite plates, bolted joints, aluminium plates and subsequently applied to concrete for damage detection (Park 2003), load sensing and strength monitoring (Soh and Bhalla 2005).

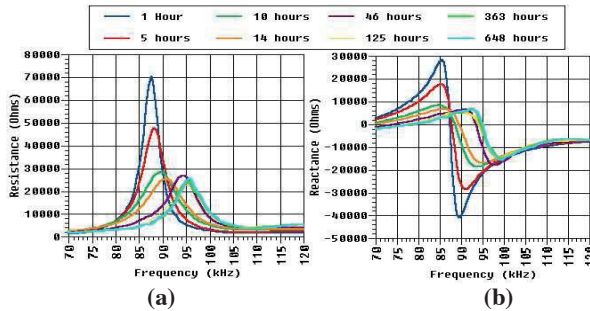
### 3.2. Sensor Design & Experimental Set up

Piezoceramics were specifically selected for use with the AD5933 impedance chip in a wireless sensing system. The AD5933 from Analogue Devices (Analogue Devices 2010) is a high precision impedance converter network analyser with a maximum excitation frequency of 100 kHz. Park et al (Park 2003) define the measurement frequencies as between 70 kHz and 500 kHz. The use of the AD5933 limited the measurement range to 70 – 100 kHz. A piezoelectric ceramic was selected with showed resonant characteristics within this range as at resonance the material is most sensitive to changes in its surroundings. The work by Chen et al (Chen, Wen et al. 2006) found that the antiresonance shows greater monotonicity so it was decided to select a material with an anti-resonance located within the 70-100 kHz frequency range. The material chosen was a soft PZT PIC 15. To prevent electrical discharge of the ceramic within the moist concrete and also to protect it from the aggressive conditions within concrete the sensor was packaged within an epoxy which was specifically chosen so as to not introduce any weaknesses into the concrete structure.

The measurement system consisted of an impedance analyser (HP4192A) to prove the concept and also act as a comparison with the AD5933, the sensor and a computer. A frequency sweep of 50 – 150 kHz was chosen with frequency steps of 0.25 kHz. As the packaged piezoelectric material showed a clear resistance peak at 85.5 kHz the sweep of the AD5933 was chosen to be from 70 – 105 kHz in steps of 0.07 kHz. The HP4192A performed a sweep each hour while the AD5933 performed a sweep daily. The work of Shin (Shin, Qureshi et al. 2008) indicated that the statistical methods like the Root Mean Square Deviation method may not be the most suitable for monitoring the condition of the structure as they cannot differentiate between strength gain and loss. For this reason it was decided to examine the resonant/antiresonant frequency shift index to monitor the condition of the concrete. It was also decided to examine the peak value of impedance and admittance during both the strength development stage and the loading sequences.

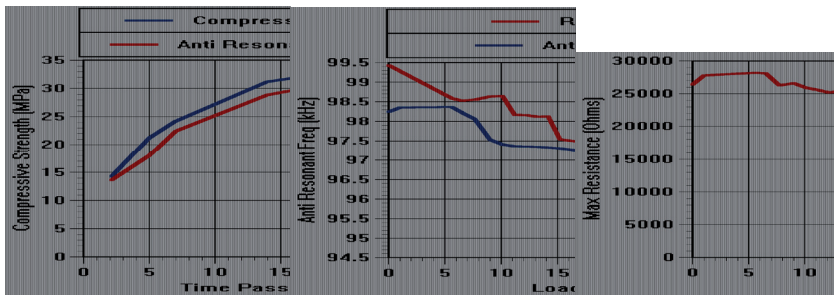
The concrete was placed into 150 mm moulds with the sensors placed in the centre of the concrete. The concrete was covered with a waterproof sheet to limit moisture loss. This covering was removed after 24 hours and the concrete was allowed to cure at room condition. After 30 days of curing the sample was placed within a hydraulic compression testing machine and the load incrementally increased until failure occurred. The resonant frequency shift and the maximum impedance and admittance values were recorded during all stages of the testing Twelve sample cubes were poured in conjunction with the tested specimen from the same mix and these cubes were compressively tested at days 2, 5, 7, 14, 21 and 28 and compared with the response from the sensor in the test cube to determine if the sensor had the ability to monitor the actual strength development of the concrete.

### 3.3. Results and Discussion of Testing



**Figure 4 Development of (a) Resistance & (b) Reactance graph as concrete**

Figure 4 (a) and (b) show the development of the impedance components, resistance and reactance as the concrete hydrates and hardens around the sensor. It can be clearly seen that as the concrete hardens the sweep curve shifts to the right. This shift is caused by changes in the stiffness of the structure while the change in the shape of the curve is related to damping. Analysis of various frequency sweeps show that the reactance antiresonance is more suitable for monitoring the development of strength as the damping effects of the structure cause the resistance peak position to be less prominent and more difficult to determine accurately. It is claimed reactance is more sensitive to temperature changes (Park 2003), but analysis of the temperature profile of the concrete has shown that the temperature effects cause negligible deviation in the development of the reactance graphs. This indicated that it may be possible to use the reactance as an indicator of the development of the strength of the concrete.



**Figure 5: Analysis of loading response (a) Anti Resonance during Strength Development (b) Resonant Curves during loading (c) Development of Peak Resistance during loading**

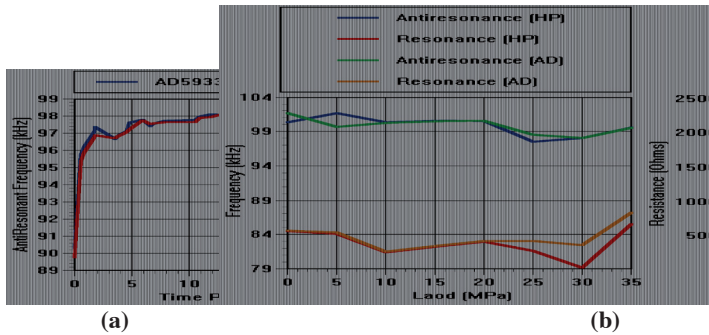
Figure 5 (a) shows the development of the antiresonant frequency shift during the strength development stage compared to compressive strength of the samples poured in parallel. As can be clearly seen the antiresonant frequency shift index shows a similar development to that of the compressive strength. The designed sensor also showed a resonant frequency during the tests. Analysis of the resonant frequency shift showed that the resonant frequency shift follows the compressive strength development curve of the concrete slightly more accurately than the antiresonant frequency shift but its sensitivity means that it is more sensitive to smaller changes which can greatly affect its response. This makes the antiresonant frequency shift

index more stable for monitoring the condition of the concrete as it cures, especially during the first 10-12 days of the concrete's life. Figure 5 (b) and (c) show the response of the sensor during the loading process. The concrete was loaded until failure occurred at 32.5 MPa. Comparison of Figure 5 (a) of the compressive test results of the sample cubes show that the samples failed at approximately the same load as the concrete containing the sensor. This indicates that the sensor does not adversely affect the strength of the concrete which is essential in the design of any embedded sensor. The shape of the curves in Figure 5 (b) and (c) can be explained with consideration of the failure mechanics of concrete. It is further proposed that the max impedance value represents the condition of the bond between the sensor and the cement. When the concrete is first loaded it causes the cracks which appeared in the curing stage due to differential shrinkage and creep to merge which increases the stiffness of the concrete. This can be seen in both graphs 0 - 7 MPa region. In this region the concrete recovers sufficiently when the load is removed. As the loading is increased beyond this stage the load applied surpasses the load the concrete can withstand and new cracks begin to form which weakens the structure of the concrete. This occurs above 7 MPa and can be seen in both the resonant and antiresonant graphs. As the load is increased the occurrence of these cracks increases which continues to undermine the strength of the concrete until the cracks combine to form larger cracks after which the concrete loses stiffness more rapidly until failure. This point can be seen at approximately the 20 MPa where the antiresonant and resonant frequencies decrease at a quickening rate until failure. This can also be seen in the value for max resistance. If as proposed this represents the cement sensor interface the cracks which form do not have a significant effect until approximately the 25 MPa point whereby the cracking within the structure begins to affect the bond at this interface. In concrete this bond is generally regarded the weakest point and failure here precipitates failure of the structure. The sensor can be used to represent the condition of the aggregate cement bond and thus give vital information on the condition of the concrete. Again in these and further tests the antiresonant frequency shift shows greater stability than the resonant frequency shift and seems more suitable for monitoring purposes.

### **3.4. Analysis of the accuracy of the AD5933 Impedance Chip**

The AD5933 and HP4192A show a similar response to the hardening concrete when the AD5933 is calibrated using an automated calibration method. As can be seen





**Figure 6 Comparison of HP419A & AD5933 for (a) Strength Development (b) Loading (c) Max Admittance and Impedance**

from Figure 6 (a), (b) and (c) (peak frequency) the AD5933 accurately follows the HP4192A. The error can be accounted for by the fact that the impedance chip must be more regularly calibrated. This can be especially seen in Figure 6 (c). An automated method for calibrating the impedance chip has been designed which is essential for the sensor working independently of the HP4192A which is essential for the operation of a complete monitoring system.

#### 4. Conclusions

The results of the research have shown that it is feasible to use the 433 MHz ISM band to extract data from sensors embedded within concrete. It was found that as expected the transmission distance of the sensors was greatly reduced but data was successfully transmitted out of the concrete from a depth of over 0.5 metres and a further distance of approximately 3.5m. The successful transmission of temperature and RH data further added to confidence in the system to be used as a wireless sensing platform. Only one sensor monitored the RH accurately but failed after 10 days of monitoring. The fact that the temperature readings were not affected indicates that liquid had condensed on the humidity sensor causing early failure. This suggests that the Gore Vent may not be the most suitable protection for the sensor.

The use of piezoelectric ceramics in an embedded sensing platform was subsequently investigated. The sensor was designed to be incorporated with the AD5933 impedance chip and along with the packaging material was designed to mimic a piece of aggregate, and hence, not introduce weaknesses or defects into the concrete. The condition of the concrete can be determined by monitoring the antiresonant frequency shift index in conjunction with the max impedance values which allow it to monitor the strength development and deterioration of the concrete. Subsequent compressive testing indicated that it does not introduce weaknesses into the structure. When compared with the HP4192A impedance analyser the AD5933 impedance chip shows close correlation. The sensor presented in this paper was as such a complete monitoring solution for monitoring the structural health of concrete from first pour until its deterioration.

## 5. Acknowledgements

This research was funded in part by the Technological Sector Research Strand III 2006 project "Smart Systems Integration" funded by the Higher Education Authority. Access to the humidity chamber and development of the motes was funded under the Tyndall National Access Program project no. 183 "Smart System for Monitoring Concrete Curing & Structural Health".

## 6. References

- Analogue Devices. (2010). "AD5933, <http://www.analog.com/en/rfif-components/direct-digital-synthesis-dds/ad5933/products/product.html>." Retrieved June, 2010.
- Andringa, M., J. Puryear, et al. (2007). In situ measurement of conductivity and temperature during concrete curing using passive wireless sensors. *Sensors and Smart Structures Technologies for Civil, Mechanical, and Aerospace Systems*. Proc. SPIE. 6529.
- Bernhard, J. T., K. Hietpas, et al. (2003). An interdisciplinary effort to develop a wireless embedded sensor system to monitor and assess corrosion in the tendons of prestressed concrete girders. *Wireless Communication Technology, 2003. IEEE Topical Conference on*.
- Bhalla, S. and C. K. Soh (2004). "Structural health monitoring by piezo-impedance transducers. I: Modeling." *Journal of Aerospace Engineering* 17(4): 154-165.
- Chen, Y., Y. Wen, et al. (2006). "Characterization of PZT ceramic transducer embedded in concrete." *Sensors and Actuators A: Physical* 128(1): 116-124.
- Flynn, B. O., A. Lynch, et al. (2006). "The Tyndall Mote, enabling wireless research and practical sensor application development." *Advances in Pervasive computing 2006* Vol. 207.
- Gore Membrane Vents. "[http://www.gore.com/MungoBlobs/506/1021/gore\\_ePTFE\\_fibers\\_solution.pdf](http://www.gore.com/MungoBlobs/506/1021/gore_ePTFE_fibers_solution.pdf)." Retrieved March, 2008.
- Grasley, Z. C., D. A. Lange, et al. (2006). "Internal relative humidity and drying stress gradients in concrete." *Materials and Structures* 39(9): 901-909.
- Jin, X. and M. Ali (2010). "Embedded Antennas in dry and saturated concrete for application in wireless sensors." *Progress in Electromagnetics Research PIER* 102: 197-211.
- Molina, L. (1992). On predicting the influence of curing conditions on the degree of hydration. CBI Report 5:92. Stockholm, Sweden, Swedish cement and concrete research institute.
- Park, G., Sohn, H., Farrar, C.R. and Inman, D.J. (2003). "Overview of piezoelectric impedance-based health monitoring and path forward." *Shock Vib Dig.* v35: 451-463.
- Pentz, D. (1994). Survey of recent cementitious materials research in Western Europe. NISTIR 5480, US Dept of Commerce.
- Porret, A. S., T. Melly, et al. (2000). A low-power low-voltage transceiver architecture suitable for wireless distributed sensors network. *Circuits and Systems, 2000. Proceedings. ISCAS 2000 Geneva. The 2000 IEEE International Symposium on*.

Saafi, M. and P. Romine (2004). Embedded MEMS for health monitoring and management of civil infrastructure, SPIE.

Shams, K. M. Z., M. Ali, et al. (2006). Characteristics of an Embedded Microstrip Patch Antenna for Wireless Infrastructure Health Monitoring. Antennas and Propagation Society International Symposium 2006, IEEE.

Shams, K. M. Z., A. M. Miah, et al. (2007). Gain and transmission properties of an embedded microstrip patch antenna for structural health monitoring application. Antennas and Propagation Society International Symposium, 2007 IEEE.

Shin, S. W., A. R. Qureshi, et al. (2008). "Piezoelectric sensor based nondestructive active monitoring of strength gain in concrete." *Smart Materials & Structures* 17(5): -.

SHT11 Datasheet. (2008 ). " [http://www.sensirion.ch/en/01\\_humidity\\_sensors/03\\_humidity\\_sensor\\_sht15.htm](http://www.sensirion.ch/en/01_humidity_sensors/03_humidity_sensor_sht15.htm)." 2008.

Soh, C. K. and S. Bhalla (2005). "Calibration of piezo-impedance transducers for strength prediction and damage assessment of concrete " *Smart Materials and Structures* 14(4): 671.

Sokoll, T. and A. F. Jacob (2007). "In-situ moisture detection system with a vector network analyser." *Measurement Science & Technology* 18(4): 1088-1093.

Wu, J. and W. Wu (2009). "Study on wireless sensing for monitoring the corrosion of reinforcement in concrete structures." *Measurement* 43(3): 375-380.



# Turbidity Based Suspended Sediment Fluxes in the Owenabue Catchment, Ireland.

Harrington Seán, Harrington Joseph

Cork Institute of Technology, Rossa Avenue, Bishopstown, Cork  
Email: sean.harrington@cit.ie

## Abstract

This paper presents the results of a field monitoring programme for turbidity and suspended sediment concentrations (C) at Ballea Bridge on the River Owenabue in the South Western River Basin District (SWRBD). The turbidity data has been used as a surrogate for C and coupled to river flow data to estimate suspended sediment fluxes. Weekly water samples were collected and tested for C and turbidity using a portable turbidity unit and the results analysed. Analysis shows that in-situ turbidity is an excellent surrogate for C ( $r^2 = 0.967$ ). This paper highlights the disproportionate impact that high intensity short duration events have on the transport of suspended sediment and highlights the importance of continuous monitoring of C for estimation of accurate suspended sediment fluxes.

## Keywords

Water Sampling, turbidity, suspended sediment concentration

## 1. Introduction

The importance of fine sediment transport in river systems has been highlighted in recent years (Walling *et al.*, 2001; Zonata *et al.*, 2005; Edwards & Withers, 2007 and Horowitz, 2008) and the quantification of fine sediment transport has become a key feature in assessing, for example, water quality trends where fine sediment fluxes rather than concentrations are compared (Horowitz, 2008). The calculation of the suspended sediment (SS) flux in a river system requires data on both discharge (Q) and suspended sediment concentration (C). The theoretical load (or flux) of SS transported in a river over a given time interval is given by:

$$L_s = \int_{t_1}^{t_2} Q(t)C(t)dt \quad (1)$$

where  $L_s$  is load for the period ( $t_2 - t_1$ ),  $Q(t)$  is the flow rate at time  $t$  and  $C(t)$  is the suspended sediment concentration at time  $t$ . Continuous discharge and SS concentration data allows the most accurate estimate of 'true' load. The use of turbidity as a surrogate for suspended sediment concentration has been addressed by for example Jansson (1992), Lewis (1996), Riley (1998) and Horowitz (2008). Turbidity is the optical property resulting from the scattering of light by suspended particles and is measured in Nephelometric Turbidity Units (NTU). This optical turbidity approach is generally considered to be a good proxy to measure SS concentrations but is sensitive to the grain size distribution of the suspended material and also to the interferences of the colour of particles, the watery medium, the ratio

between size and shape of particles, particle density, and content of dissolved particles. Linear relationships between turbidity and suspended sediment concentration have been developed in various studies (Lenzi & Marchi, 2000; Pavanelli & Biggi 2005; Chanson *et al.*, 2008). However, variations in grain size distribution (particularly at the coarser sizes) associated with floods, may cause non-linear relationships to occur between turbidity and SS concentration. Furthermore, the relationship between SS concentration and turbidity is not well proven for high suspended sediment concentrations ( $> 10,000 \text{ mg L}^{-1}$ ).

In an Irish context, work in this area is limited and annual fluxes using continuous data have not yet been presented. Recent work by Harrington & Harrington (2010) was based on manual storm based sampling and used the flow duration – rating curve method of load estimation. An annual load for the Owenabue catchment was estimated to be  $2305 \text{ t yr}^{-1}$ . The work by Harrington & Harrington (2010) calculates fluxes and yields, and provides cross catchment comparison, but does not allow analysis of the contribution of storm events to the annual flux which can be extremely important (Zonta *et al.*, 2005; Rovira & Batalla, 2006).

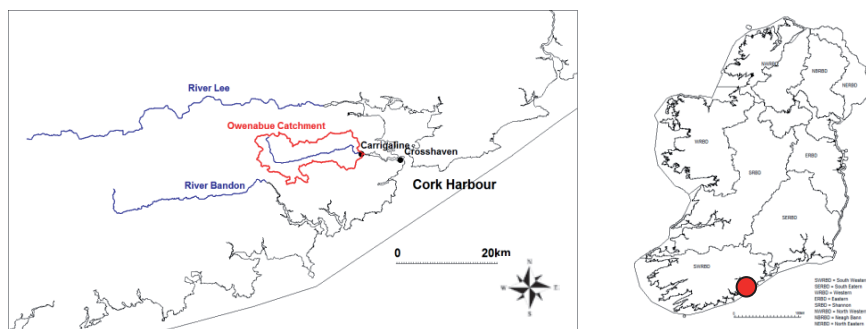
This paper presents the analysis and results for Ireland using turbidity measurements as a surrogate for suspended sediment concentration including the contribution of high flow storm based events. Improved understanding and accuracy of SS concentrations, fluxes and dynamics will contribute to the management of Irish river basins in the context of the implementation of the EU Water Framework Directive.

## 2. Catchment Characteristics

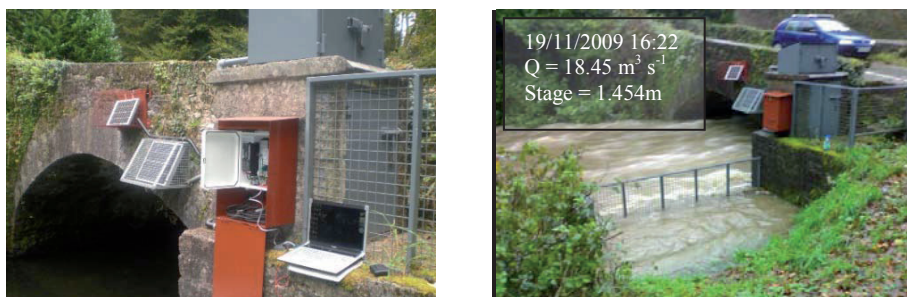
This paper focuses on the River Owenabue catchment which drains into Lough Beg at Carrigaline, which in turn drains into Cork Harbour at Crosshaven (Figure 1). Details for the  $205 \text{ km}^2$  catchment and the hydrometric station at Ballea Bridge Lower are given in Table 1. The catchment is a small uncontrolled catchment and high suspended sediment concentrations are found in the river compared to other SWRBD catchments including, for example, the nearby Bandon River. The slope of the river is relatively shallow along much of the river's course, with an average slope of  $6.34 \text{ m km}^{-1}$  based on analysis of Discovery Series Raster 50 Ordinance Survey Ireland maps, although it is quite steep near the source. However, the catchment itself is quite steep to the north and south of the east flowing river, which increases the sediment availability compared to less steep catchments such as the Bandon.

The Ballea Bridge Lower hydrometric station consists of an automatic water level recorder which is maintained and operated by the Office of Public Works (OPW). Figure 2 show the Station at Ballea Bridge. Water level is recorded at 15 minute intervals. The water level can then be converted to flow rate using a site specific stage discharge curve. There is a good stage discharge relationship at this location with the single span stone arch bridge and a vee-weir confining the flow. However further calibration is required to increase confidence in the stage discharge relationship at water levels above 0.9m (on the staff gauge) which is equivalent to

$14.26 \text{ m}^3 \text{ s}^{-1}$  (Freehill, 2010). Figure 2 shows a flood event on the river during November 2009.



**Figure 1: Owenabue Catchment**



**Figure 2: Ballea Bridge Lower Hydrometric Station and a typical flood flow from November 2009**

Parameter	Detail	Parameter	Detail
<b><u>River Details:</u></b>		<b><u>Station:</u></b>	
Sub-Catchment (of the Lee)	Owenabue	Station Catchment Area	103 km <sup>2</sup>
River Length	22.71 km	Length to Station	19.05 km
Sub-Catchment Area	205 km <sup>2</sup>	Station Type	Data Logger
Altitude at source	110m OD	Body Responsible	Office of Public Works
Average Slope	6.34 m km <sup>-1</sup> (from OS maps)	Co-ordinates	51.82N, 8.42W
Average Flow Rate	2.294 m <sup>3</sup> s <sup>-1</sup>	Staff Gauge Zero	11.29 m O.D.
Annual Average Rainfall	1272 mm/year (1971-2000)	Records Available	1956-2010
Land Use	Tillage, pasture, forestry, urban		

**Table 1: Summary Data for the Owenabue River Catchment and Hydrometric Station**

### 3. Methodology

A total of 49 manual surface grab samples were collected between 15/9/2009 and 15/9/2010. Each sample was laboratory tested for suspended sediment concentration and turbidity. Suspended sediment concentration was found using Method 2540 D of the American Public Health Association (APHA). For samples with a high SS concentration (C) value a vacuum pump was used to reduce filtering time. The turbidity of each sample was found using a Hanna Instruments Portable Microprocessor Turbidity Meter (Model No. HI93703).

Tests were conducted to confirm the suitability of using surface grab samples by comparing the C value of surface grab and depth integrated samples. Depth integrated samples were collected using a USGS DH-76 depth integrating sampler. 18 samples were collected for a wide range of suspended sediment concentration values (0.18 to 117 mg L<sup>-1</sup>) using each sampling method and the suspended sediment concentration values compared. Results confirmed that surface grab samples were representative of depth integrated samples at this sampling location.

In-situ turbidity was monitored for the period 15/9/2009 to 15/9/2010 using a Campbell Scientific OBS 3+ probe connected to a CR800 logger and measured at 15 minute intervals, to match the resolution of the OPW's automatic water level recorder. In-situ turbidity measurements were converted to suspended sediment concentration using a linear relationship developed by comparing the results of the in-situ turbidity probe and the measured C value from manually collected samples. Details of the analysis are presented in Section 4.1. Suspended sediment fluxes were calculated by applying equation (1) over the time period of the data record.

Hysteresis is the phenomenon where the C value corresponding to a particular flow rate value differs on the rising and falling limbs of the hydrograph. This may be due to different factors including sediment depletion, flow paths, sediment riverine storage, land use and late sediment supply from tributaries (Evans & Davies, 1998). In this paper, hysteretic relationships between suspended sediment concentration and flow rate were analysed following Williams (1989). Suspended sediment concentration to flow rate (C/Q) ratios were constructed for a particular Q value on both the rising and falling limb of the hydrograph to allow comparison within and across events.

## 4. Results and Discussion

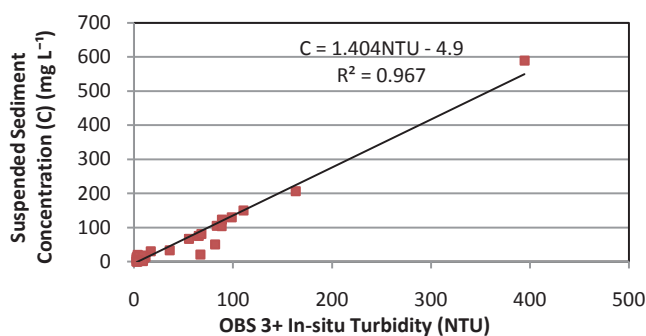
### 4.1. Turbidity and Suspended Sediment Concentration Relationships

The analysis of the 49 manual samples collected between 15/9/2009 and 15/9/2010 allows comparison between suspended sediment concentration, in-situ turbidity and portable turbidity. Samples were collected over a large and representative discharge range on the river from 0.37 to 16.66 m<sup>3</sup> s<sup>-1</sup>; the long-term average river flow rate on the river is 2.29 m<sup>3</sup> s<sup>-1</sup>. In-situ turbidity was found to be an excellent predictor of suspended sediment concentration with an r<sup>2</sup> value of 0.967 determined. r<sup>2</sup> represents



the coefficient of determination and in this context it means 96.7% of the variability of suspended sediment concentration can be explained by the variation in turbidity. Figure 3 shows the relationship which is subsequently used in this paper to convert continuous turbidity readings to suspended sediment concentrations. If the higher turbidity point is omitted, the slope of the equation is reduced by approximately 15% and the  $r^2$  reduces by 4% to 0.920. This shows that if higher calibration points are not included, a possible underestimation would occur in this case.

The relationship between the portable turbidity value and suspended sediment concentration was found to have an  $r^2$  value of 0.989. This implies that portable turbidity is a better predictor of suspended sediment concentration. However, portable turbidity and suspended sediment concentration are measured from the same sample, and thus the relationship is likely to be better. The relationships found show that turbidity is an excellent surrogate for suspended sediment concentration. Similarly, the relationship between the portable turbidity and in-situ turbidity can be assessed and was found to have an  $r^2$  value of 0.841.



**Figure 3: Suspended sediment concentration versus in-situ turbidity on the River Owenabue**

#### 4.2. Flux Estimates

The annual suspended sediment flux was estimated for the period 15/9/2009 to 15/9/2010 by applying equation (1) over the time period for each event. The annual flux passing the Ballea Bridge Lower gauging station was found to be 2635 tonnes (t). The load analysis reveals that 85% of the total annual flux is transported over 10% of the year and 69% of the flux over 5% of the year. Similar such results have been reported for other rivers where a disproportionate amount of the load is transported during high flow short duration storm based events (Rovira & Batalla, 2006; Drewry *et al.*, 2008).

The magnitude of the flux estimate of 2635 t compares favourably with the flux estimate of 2305 t for the period 1/10/2007 to 30/9/2008 by Harrington & Harrington (2010), based on a storm event based manual sampling programme and using the flow duration-rating curve method of load estimation. However, it should be noted

that the estimates based on the manual sampling programme are less likely to capture the full extent and influence of high flow events.

### 4.3. November 2009 Events

The extreme rainfall and flood events of November 2009 were caused by a series of fast-moving deep Atlantic depressions which brought active frontal systems across Ireland. The heaviest rainfall was recorded on the 1st, 9th, for the period from the 16th to 19th and on the 21<sup>st</sup> of November (Walsh, 2010). The high river flows experienced during November 2009 provide an excellent period over which to analyse the contribution of short duration high flow events to the annual suspended sediment flux.

The overall flooding period of November 2009 can be considered to consist of four sub-events (identified here as Events 1 – 4); three events with peak flows of approximately  $13.3 \text{ m}^3 \text{ s}^{-1}$  followed by a larger flood event. Table 2 provides summary data for each sub-event analysed.

Event	Duration (hrs)	SS Flux (t)	Avg. C ( $\text{mg L}^{-1}$ )	Avg. Q ( $\text{m}^3 \text{ s}^{-1}$ )	Peak C ( $\text{mg L}^{-1}$ )	Peak Q ( $\text{m}^3 \text{ s}^{-1}$ )	$C_1/Q_1$	$C_2/Q_1$	$C_1/Q_1$ $C_2/Q_1$
Event 1	51	154	72	10.03	836	13.3	52	8.5	6.1
Event 2	54	107	46	11.24	214	13.3	16	6.3	2.5
Event 3	55	103	44	11.35	139	13.3	8	5.5	1.5
Event 4	276	370	28	11.19	153	19.6	11	2.0	5.5
Event 5	57	25.6	33	2.93	155	5.64	7.3	9.3	0.8

$Q_1$  = A given flow rate for an event which is less than the peak flow rate.

$C_1$  = Suspended sediment concentration on the rising limb of the hydrograph at  $Q_1$

$C_2$  = Suspended sediment concentration on the falling limb of the hydrograph at  $Q_1$

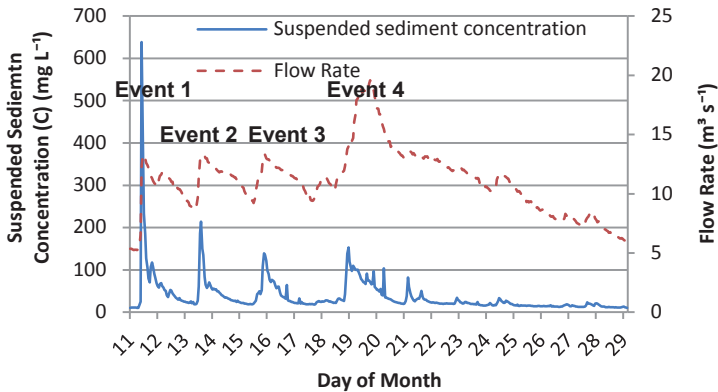
**Table 2: Summary of high flow events on the Owenabue River in October and November 2009**

The events had a peak flow of  $19.58 \text{ m}^3 \text{ s}^{-1}$  (a return period of approximately 10 years) and a peak C value of  $836 \text{ mg L}^{-1}$ . Each event had a duration of between 51 and 55 hours, while Event 4 lasted for a period of 276 hours. The first flood event started on the 11<sup>th</sup> November (Figure 4), the second on the 13<sup>th</sup>, the third on 15<sup>th</sup> and the last and largest on the 18<sup>th</sup> November. Another event (identified as Event 5) in October 2009 is also included in Table 2 for comparison purposes. Analysis of this event is presented in Section 4.4. Figure 4 presents the flow rates and suspended sediment concentrations for the November 2009 event.

The total suspended sediment flux over the specific November period is estimated at 737 t and represents approximately 28% of the annual flux which is delivered over 5% of the year. The results for this November 2009 event suggest that in general peak suspended sediment concentration precedes peak flow rate. However, this changes with successive events. The flow duration near peak flow reduces with

successive events as seen in Figure 5 where the flow rate declines more rapidly after each successive peak. The interval between the points in Figure 5 is 15 minutes. Figure 5 also shows that the peak suspended sediment concentration generally declines with each sub-event indicating a progressive exhaustion of the suspended sediment supply due to the effect of the successive previous events.

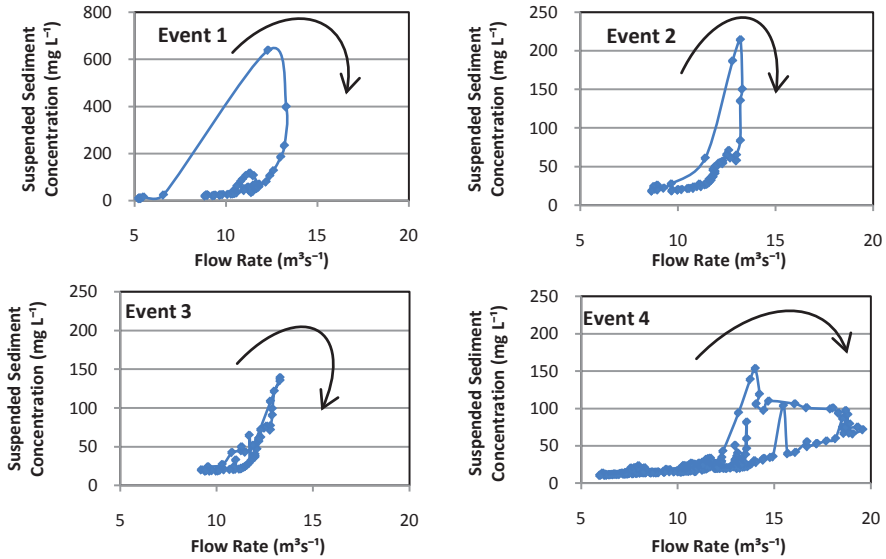
A clockwise hysteresis loop (Figure 5) was observed for Events 1 to 4 indicating that the river became supply limited, meaning the quantity of material available for transport was limited by the sediment supply (rather than by the flow rate)



**Figure 4: Flow rates and suspended sediment concentrations during November 2009**

Table 2 above shows that peak concentration successively reduces from Event 1 to 3 and the C values reduce more rapidly after peak Q for successive events.

A disproportionately large quantity of the suspended sediment flux for Event 1 is delivered during the initial hours of the event, with 32% of the load delivered in the first 12 hours (21% of the duration of Event 1). The percentage of the suspended sediment flux delivered in the first 12 hours for Event 2 and Event 3 reduces to 25% and 18% of the event duration respectively. It is clear that the initial hours of the event transport a disproportionately large quantity of the SS flux, although, if preceded by other events of similar flow magnitude the percentage delivered in the early stages of the events reduces for successive events.

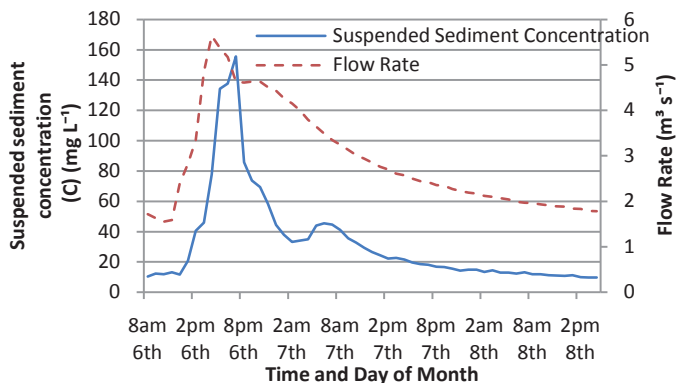


**Figure 5: Hysteresis Loops of Events 1 to 4 during November 2009**  
(Note vertical scale different for Event 1)

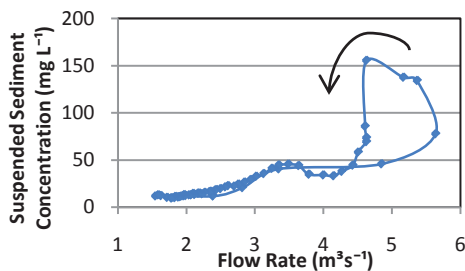
#### 4.4. October 2009 Event

A smaller event (Event 5) occurred on 6<sup>th</sup> October 2009, with a peak recorded flow rate of  $5.64 \text{ m}^3 \text{ s}^{-1}$ , which has an exceedance frequency of 9% (Figure 6). The estimated SS flux for the 57 hour event was found to be 25.6 t. Similar to the November flood events, 44% of the flux is transported in the first 12 hours, highlighting the importance of capturing data on the rising limb of the hydrograph. A counter clockwise figure of eight hysteresis loop (Figure 7) was observed, with peak C recorded after the peak Q on the falling limb of the hydrograph. This particular event was flow limited; meaning the quantity of sediment transported was controlled by the flow rate of the river.

A subsequent mini-peak in C was observed at around 7am on the 7/10/2009 (Figure 6) which is independent of flow rate. There are a number of possible explanations for this such as the late delivery of suspended sediment at the gauging station due to smaller tributaries of the river or from the spatial variation of rainfall within the catchment (Rovira & Batalla, 2006).



**Figure 6: Flow rates and suspended sediment concentrations during October 2009 (Event 5)**



**Figure 7: Hysteretic Loop of Event 5 during October 2009**

## 5. Conclusions

This paper examined the application of turbidity as a surrogate for suspended sediment. Turbidity is an excellent indicator of suspended sediment concentration at the Ballea Bridge Lower gauging station on the River Owenabue with a coefficient of determination,  $r^2$ , of 0.967.

The annual SS flux determined for the period 15/9/2009 to 15/9/2010 is 2635 t. A peak suspended sediment concentration of  $836 \text{ mg L}^{-1}$  was recorded and the peak recorded flow rate was  $19.6 \text{ m}^3 \text{ s}^{-1}$ . Two types of event were analysed; high flow events with peak  $Q$  greater than  $13.3 \text{ m}^3 \text{ s}^{-1}$  from November 2009 (Events 1 to 4), and a smaller event with a peak  $Q$  of  $5.64 \text{ m}^3 \text{ s}^{-1}$  from October 2009 (Event 5).

During the flood events of November 2009, a SS flux of 737 t was estimated. During each of the successive events of similar peak flow rate (Events 1-3) the peak suspended sediment concentration was lower than for the previous event, the peak duration was shorter and the flow rate and concentration reduced more rapidly after peak flow rate with a reduction in SS flux observed for successive events. These results show that the suspended sediment load transported during an event is

determined not only by flow rate and duration, but also by its inter-event position. It is likely that high flow events that occur after periods of relatively low flow carry most suspended sediment.

Analysis shows that high intensity events contribute disproportionately to SS flux and that most of the SS flux is transported in the initial stages of the event which in general coincides with the rising limb of the hydrograph. This paper shows that, in general, flow rate is the main factor influencing SS transport in the River Owenabue for the period studied.

The limitations of manual sampling in understanding the dynamics of suspended sediment transport are highlighted by this paper. Although manual storm based sampling may produce a good estimate of annual flux it may not reflect the effect of high intensity short term flux events or not allow shorter term fluxes to be calculated or identify the related delivery sequence, which may be as important as the load itself in certain circumstances. Using continuous turbidity data as a surrogate for suspended sediment concentration allows reliable SS flux estimates to be developed and increases our understanding for short duration flood events and their contribution to SS fluxes.

## 6. Acknowledgements

The authors wish to acknowledge the research funding received from the Government of Ireland/Institutes of Technology Technological Sector Research Strand I Postgraduate R&D Skills Programme. The authors also wish to acknowledge the support received from the Office of Public Works in providing river flow and associated data.

## 7. References

- Chanson, H., Takeuchi, M., Trevethan, M., (2008), '*Using turbidity and acoustic backscatter intensity as surrogate measures of suspended sediment concentration in a small subtropical estuary*', Journal of Environmental Management, Vol. 88, pp. 1406-1416.
- Drewry, J.J., Newham, L.T.H., Croke, B.F.W., (2008), '*Suspended Sediment, nitrogen and phosphorus concentrations and exports during storm-events to the Tuross estuary, Australia*', Journal of Environmental Management, doi:10.1016/j.jenvman.2008.02.004.
- Edwards, A.C., Withers, P.J.A., (2007), '*Transport and delivery of suspended solids, nitrogen and phosphorus from various sources to freshwaters in the UK*', J. Hydrology, doi:10.1016/j.jhydrol.2007.10.053.
- Evans, C., Davies, T.D., (1998), '*Causes of concentration/discharge hysteresis and its potential as a tool for analysis of episode hydrochemistry*', Water Resour Res, Vol. 34, pp. 129-137.
- Freehill, K., (2010), Hydrology & Hydrometric Services, Office of Public Works, Main Street, Headford, Co. Galway, personal communication, 13<sup>th</sup> May 2010.

Harrington S.T.M., Harrington, J.R., (2010), '*Initial estimates of suspended sediment loads for selected rivers in the South Western River Basin District (SWRBD)*', Ireland, Submitted to Catena, July 2010.

Horowitz, A.J., (2008), '*Determining annual suspended sediment and sediment-associated trace element and nutrient fluxes*', Science of the Total Environment 400, 315-343.

Jansson, M.B., (1992), '*Turbidimeter measurements in a tropical river, Costa Rica*'. In: Bogen, J., Walling, D.E., Day, T.J., (EDS), Erosion and Sediment Transport Monitoring Programmes in River Basins, IAHS Publ. no. 210. pp. 71-78.

Lenzi, M.A., Marchi, L., (2000), '*Suspended sediment load during floods in a small stream of the Dolomites (northeastern Italy)*', Catena 39 (2000), 267-282.

Lewis, J., (1996), '*Turbidity controlled suspended sediment sampling for run-off event load estimation*', Water Resour. Res. 32 (7), 2299-2310.

Pavanelli, D., Bigi, A., (2005), '*Indirect analysis methods to estimate suspended sediment concentration: reliability and relationship of turbidity and settleable solids*', Biosystems Engineering, 90(1), 75-83.

Riley, S.J., (1998), '*The sediment concentration-turbidity relation: its value in monitoring at Ranger Uranium Mine Northern Territory, Australia*', Catena 32 (1), 1-14.

Rovira, A. and Batalla, R.J., (2006), '*Temporal distribution of suspended sediment transport in a Mediterranean basin: The Lower Tordera (NE Spain)*', Geomorphology 79, 58-71.

Walling, D.E., Webb, B.W., Russell, M.A., (1997), '*Sediment associated nutrient transport in UK rivers*'. In Freshwater contamination (Proc Rabat Symp, April – May, 1997), Int Assoc Hydrol Sci, IAHS Publ. no. 243: 69-81

Walling, D.E., Russell, M.A., Webb, B.W., (2001), '*Controls on the nutrient content of suspended sediment transported by British rivers*', Science of the Total Environment, 266 (2001) 113-123.

Walsh, S., (2010), '*Report on rainfall of November 2009*', Climatological Note No. 12, Met Eireann, Glasnevin Hill, Dublin.

Williams, G.P., (1989), '*Sediment concentration versus water discharge during single hydrologic events in rivers*', J. Hydrology, Vol. 111, pp. 89-106.

Zonata, R., Collavini, F., Zaggia, L., Zuliani, A., (2005), '*The effect of floods on the transport of suspended sediments and contaminants: A case study from the estuary of the Dese River (Venice Lagoon, Italy)*', Environmental International, Vol. 31 pp. 948-958.





# An Energy Balance of Biomethane from Energy Crops in Ireland

Eoin Deasy, Niamh Power

Department of Civil, Structural and Environmental Engineering,  
Cork Institute of Technology, Cork, Ireland.  
e-mail: niamh.power@cit.ie

## Abstract

The motivation for this research stems from the potential of biomethane to assist Ireland in meeting obligations outlined in the 'Renewable Energy Source Directive' (2009/28/EC) and also reduce dependency on fossil fuels. The purpose of this work is to establish the energy consumed and created in the production of biomethane in Ireland; allowing for calculation of the true net energy. The three energy crops investigated are wheat, maize silage and grass silage (assuming three cut grass silage). These crops have a history of growth in Ireland and have already been recognised as effective feedstocks for anaerobic digestion. The analysis is broken into three distinct stages, the energy consumption stage (crop production and biofuel processing), the energy creation stage (anaerobic digestion) and the energy balance stage. The results show that the cereal option consumes 37.7% of the energy created; for maize silage and grass silage this figure is 21.7% and 20% respectively. In conclusion, the realisation of biomethane fuel in Ireland is most favourable on an energy basis using grass silage. It must be noted that the exclusion of plastic covering in maize cultivation improves crop energy consumption by 6.2% but subsequent reduction in yield reduces net energy created by 16.3%.

## Keywords

Biomethane, Energy balance, Biofuels, Anaerobic digestion, Grass silage, Maize silage, Wheat, Ireland

## 1. Introduction

Over the past decade both national and global concern has increased over the issues of 'security of energy supply' and global warming. A move away from traditional fossil fuelled economies has long been accepted as an obvious solution yet many attempts have proved for the most part unsuccessful. The trend is unyielding; in 1974 fossil fuels accounted for 86% of all global energy and despite ambitious attempts since then only a 5% decrease in dependency was recorded (Angarita et al., 2009).

Even greater concern arises when one considers both the increase in demand for petroleum oil from developing nations added to the decline of remaining deposits; consequently the strive for alternatives has grown. The suggestion of biofuel energy as an alternative to fossil fuels has gained popularity in recent years. The belief is that biofuels can offer an indigenous energy source, direct local employment, energy security and direct environmental benefits.

The truth is that biofuels do offer a secure indigenous energy source with far ranging economic benefits but the question is; at what cost to the environment? It's this concern that has led to recent revelations of poor energy performance of both biodiesel and bioethanol. The question remains, what about one of Ireland's most promising options – biomethane?

## **2. Biofuel legislation**

### **2.1. 'Biofuel use Directive' (2003/30/EC)**

The earliest guidelines in relation to biofuel use and development in Ireland came on the 8<sup>th</sup> of May 2003 with the introduction of the 'Biofuel use Directive' (Directive 2003/30/EC). This Directive set out indicative targets for each member state; the recommendation was 2% of transport fuel be replaced by biofuels by 2005 followed by 5.75% by 2010 (Directive 2003/30/EC). To assist in reaching the 2005 target, excise relief was offered by the Irish government on 8 million litres of biofuel over two years under the 'Energy Taxation Directive'(Directive 2003/96/EC); a Directive which allowed differential tax rates across all E.U. member states. Unfortunately this was not enough to encourage an immediate increase in production and subsequently Ireland fell well-short. The European volume of transport fuel replaced by biofuels reached only 1.4% in 2005; Irelands replacement rate was recorded at approximately 0.16% in the same year (Schnepf, 2006).

### **2.2. 'Renewable Energy Source Directive' 2009/28/EC**

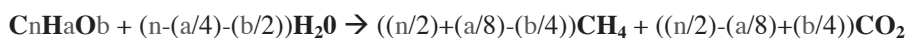
From 2005 a renewed approach was required within the European Union to allow for progress in the area of energy from renewable sources. Earlier directives had proven unsuccessful in relation to transport fuel and many felt an immediate overhaul of the 'Biofuels use Directive (2003/30/EC)' was necessary. Projections within the Biofuels use Directive stated that 5.75% of all fossil fuels were to be replaced by renewable sourced fuels by 2010; most optimistic estimates now feel 4.2% would have been an achievement (European Commission, 2008 <19 final>). After considerable modification to previous directives the 'Renewable Energy Source Directive 2009/28/EC' was established on the 23<sup>rd</sup> April 2009, all targets and requirements within the modified 'Renewable Directive' overwrote all previous renewable transport fuel directives - 2001/77/EC (renewable electricity production) and (Directive 2003/30/EC).

The Renewable Energy Source Directive (2009/28/EC) introduces an entire holistic approach to biofuels utilisation from planting of the crop to processing of the biofuel (European Commission, 2008 <19 final>). In similar fashion to previous directives, individual national targets are outlined; the key difference is that all future targets are now mandatory. The Directive addresses numerous technical issues such as interstate transfers and joint state projects between two or more member states but the most significant amendment from an Irish transport fuel perspective comes in the form of the biofuel sustainability criteria. This aspect of the Directive clearly addresses the sustainability prerequisite of various biofuels and bioliquids, critically taking into account land use, land alteration and feedstock preferences (Directive 2009/28/EC).

For Ireland, a nation predominantly covered in grassland, this means that any future biofuel infrastructure/industry will need to be tailored to meet present crop patterns (predominately forage crops). Under 2009/28/EC it is also required that the crop and biofuel chosen must save a minimum of 35% on greenhouse gas emissions. By the year 2017 and 2018, 50% and 60% of greenhouse gas emissions must be saved by utilising biofuels (European Commission, 2008 <30 final>). For this reason, biomethane is now perceived as both technically and environmentally a credible biofuel option for Ireland

### 3. Energy created

During the process of producing biomethane the primary aim is always to maximise energy creation. Wet anaerobic digestion is chosen for this analysis; the digester operates at 40°C and 14% solids with a hydraulic retention time (HRT) of 40-60 days. In the case of wheat, co-digestion with slurry is required; only energy from the crop is considered within this paper. The scrubbing and upgrading process first utilises activated carbon for sulphur removal followed by conventional water scrubbing for CO<sub>2</sub> removal - achieving methane values of 97% and greater. In order to establish the theoretical energy created from each feedstock, the following equation was used (Smyth et al., 2009):



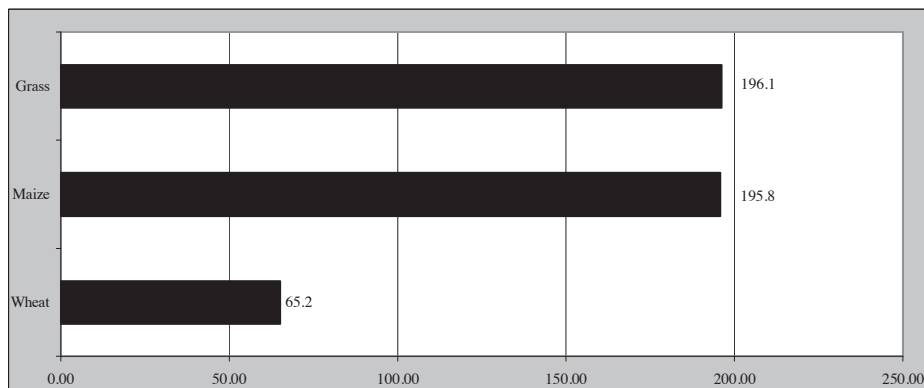
To give more realistic figures, biogas losses of minimum 2% are included. These losses occur at both the digestion stage and the upgrading stage. The losses at upgrading are generally only 0.5% (Jury et al., 2010, Jungbluth et al., 2007). The losses at digestion are as a result of seepage and losses during feedstock intake. Inclusion of these losses gives the following values. Table 1 outlines the technical aspects of each crop (incl. stoichiometric ratio) and gives estimates of biomethane production per hectare.

	<b>Grass silage</b>	<b>Maize silage</b>	<b>S. Wheat</b>
<b>Tonnes/ha</b>	54.00	60.00	7.56
<b>Stoichiometric ratio</b> (Power, 2007, Loomis and Lafitte, 1987)			
<b>C</b>	28.40	39.03	22.90
<b>H</b>	44.50	64.69	40.60
<b>O</b>	17.70	30.86	17.58
<b>Biogas (m<sup>3</sup>/ha)</b>	9,615	10,174	3,261.5
<b>CH<sub>4</sub> (%)</b>	54.00	50.95	52.9
<b>Biomethane (m<sup>3</sup>/ha)</b>	5191.9	5183.6	1,816.1

**Table 1: Biogas/biomethane created**

With the volume of biomethane for each crop option calculated, it is possible to give an overall value of the energy created per hectare, as shown in Figure 1. It is important to note the higher methane value of grass silage biogas at 54% CH<sub>4</sub>; this can be significant in relation to upgrading, especially where the level of methane is

required >95%. The gross energy in Figure 1 takes the energy value of biomethane (95% CH<sub>4</sub>) as 35.89 MJ/m<sup>3</sup> (Börjesson and Mattiasson, 2008).



**Figure 1: Energy creation (GJ/ha)**

## 4. Energy consumption

The two key areas of concern in relation to energy consumption are the crop production stage and the biofuel processing stage. Both are analysed in this paper.

### 4.1. Crop production

In order to establish the energy consumption of each crop, it is imperative that the technical challenges of each crop are investigated. The following subparagraphs shall outline the disparity in technical demands of each crop.

#### 4.1.1. Spring wheat

Wheat, one of Ireland's traditional cereal crops, is a low yielding crop in contrast with the other two forages and relatively low demanding. The spring variety has a much lower pesticide demand than that of the winter variety as fungicide application is much lower for spring sown varieties. The later establishment date of the spring option is generally less demanding in relation to fertiliser but harvesting yields are typically 0.5-0.75t/ha lower (Curtin, 2010).

#### 4.1.2. Maize silage

Maize silage is a relatively new crop to Irish agriculture. Earliest maize silage trials were held in the Republic of Ireland in the early 1970's with hopes of introducing high yielding supplementary forage to grass silage (Crowley, 1998). Maize is extremely sensitive in a cooler climatic environment; for Ireland this means that poor cultivation conditions can be detrimental to maize crop performance. Subsequently, 6µm plastic covering is now regularly used to allow for early plant development (Kwabiah, 2004). The maize silage crop has a high potassium demand with a relatively low nitrogen demand.

#### 4.1.3. Grass silage

Grass silage is the most widespread sown crop in Ireland on the back of a strong beef and dairy industry. Grass silage in Ireland is generally of perennial ryegrass variety (for this analysis three cut silage is assumed). Grass in Ireland is capable of yielding approximately 67 t/ha annually (O'Kiely, 2009). Grass silage has a high nitrogen demand with a very low pesticide demand.

#### 4.1.4. Technical analysis of the crops

Table 2 outlines the technical aspects of each crop. Grass and maize silage are relatively similar in relation to digestion; the main difference is in the frequency of crop sowing and the requirement for plastic when sowing the maize crop. Wheat shows a lower volatile solids and volatile solids destruction rate than that of the forages. The biogas yield of the cereal can be increased somewhat by incorporating a substrate cooking stage between the digestion and post digestion stage. This system is only considered feasible where excess heat is generated on-site – not suitable for biomethane plants (Gerstenberg, 2010).

	<b>Grass silage</b>	<b>Maize silage</b>	<b>Wheat</b>
<b>FM yield (t/ha)</b>	54.00 (O'Kiely, 2009)	60.00 (Crowley, 1998)	7.56
<b>Solids content</b>	25%	27.7%	80%
<b>Volatile solids</b>	92% (Nizami and Murphy)	96% (Bruni et al.)	80% (Power, 2007)
<b>V.S destruction</b>	83% (Nizami and Murphy)	83% (Bruni et al.)	80% (Power, 2007)
<b>Sowing; 1 in</b>	5	1	1
<b>No. of harvests</b>	3	1	1
<b>Demands:</b>	Nitrogen	Potassium	Pesticide
<b>Note:</b>	-	Plastic covering	-

**Table 2: Technical analysis of the three crops**

#### 4.1.5. Crop comparison

It is possible to establish the primary energy demands in crop production for wheat, maize silage, and grass silage from Table 2. The value for energy demand includes both direct and indirect. The direct energy is in the form of diesel while the indirect include fertiliser, pesticide, seed, machinery and plastic manufacturing/production. The energy required for each crop is outlined in Table 3.

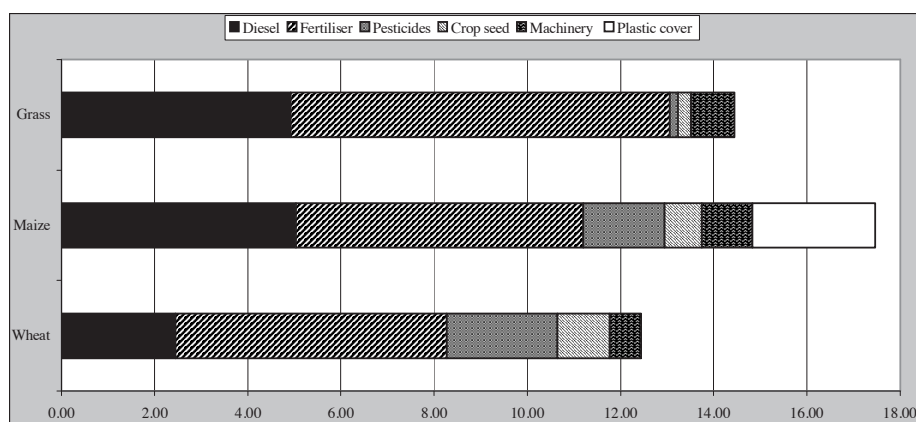
<b>Fuel (MJ/l)</b> (Murphy et al., 2004)	Diesel	40.7
<b>Synthetic Fertiliser (MJ/kg)</b>	Nitrogen (N)	40.0
(West and Marland, 2002, Tzilivakis et al., 2005, Kallivroussis et al., 2002)	Phosphorus (P)	12.0
	Potassium (K)	7.0
<b>Pesticide (MJ/l)</b>	Herbicide	266.56

(Kallivroussis et al., 2002, Green, 1987)	Fungicide	284.82
	Insecticide	288.88

**Table 3: Energy consumed by each input**

Table 3 outline the energy consumption associated with fuel, synthetic fertiliser and pesticides in crop production. The other two consumers of energy are the provision of seed and machinery production. The provision of seed for wheat, maize silage and grass silage are 1.13 GJ/ha, 0.80GJ/ha and 0.27GJ/ha respectively (West and Marland, 2002).

The energy consumed in the manufacture of machinery for wheat, maize silage and grass silage harvesting is 0.67GJ/ha, 1.08 GJ/ha and 0.93 GJ/ha (Tabatabaefar et al., 2009, Mikkola and Ahokas, 2010). The energy associated with the use of plastic covering for maize is 2.63 GJ/ha (Patel et al., 2002, Briassoulis, 2007). All of this data is collectively illustrated in Figure 2.



**Figure 2: Crop energy consumption (GJ/ha)**

Figure 2 outlines that maize silage shows the greatest demands on production energy per hectare. One significant contributor to this figure is the inclusion of plastic covering with an energy demand of 2.63 GJ/ha. The lower operation demand of wheat can also be identified, showing under half the diesel energy requirement of maize cultivation. The high nitrogen demand of grass silage is also represented; nitrogen production accounts for 56.4% of the overall grass silage energy demand.

## 4.2. Biofuel processing

### 4.2.1. Drying and storage

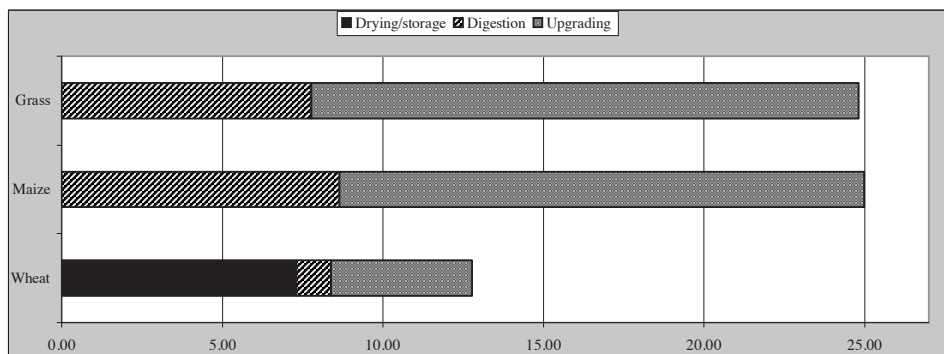
The issue of drying and storage is only an issue for biomethane production from wheat. Drying and storage of a crop can have a significant effect on the overall energy balance of a biomethane feedstock. For this analysis, it has been calculated that the drying of wheat consumes approximately 5.23 l diesel/t while ventilated storage consumes 210.4kWh<sub>e</sub> per tonne of cereal (Mecmar Batch Grain Driers, 2010,

Maier and Bakker-Arkema, 2002, Jayas and White, 2003, Sukup Manufacturing Company, 2010). This equates to an overall energy demand of 970MJ/t or 7.3 GJ/ha.

#### 4.2.2. Anaerobic digestion and upgrading

The two stages of biomethane production that contribute to energy consumption are the digestion stage and the upgrading stage. The digestion stage has both a thermal and electrical demand while the upgrading has only an electrical demand (incl. compression). Heat is only ever required in heat exchangers used to remove CO<sub>2</sub> from cleaning agent (Hildebrandt, 2010). It is assumed that biogas/biomethane created on-site is not used to provide heat for the digester units. The key energy parameters for the site are as follows (Murphy and Power, 2009, Murphy and McCarthy, 2005):

- Digester (electrical) 10kWh/t;
- Digester (Thermal) 30kWh/t;
- Upgrading and compression (electrical) 0.7kWh/m<sup>3</sup> biomethane.



**Figure 3: Biofuel processing consumption (GJ/ha)**

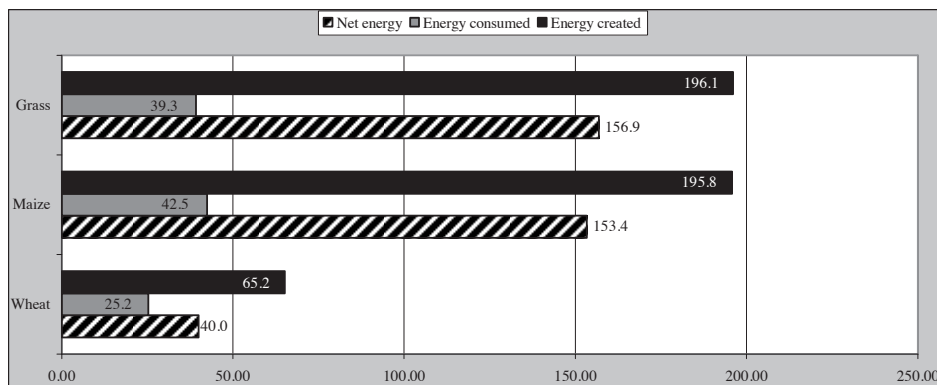
These figures can be related to land area. Digester values are easily established while the upgrading energy consumption is based on the volume of biomethane created. For wheat, maize and grass silage the biomethane yield was calculated as 1,816.1m<sup>3</sup>/ha, 5183.6m<sup>3</sup>/ha and 5191.9m<sup>3</sup>/ha respectively. All energy consumption during biomethane processing is illustrated in Figure 3.

## 5. Energy balance

The energy balance of each biomethane crop can be easily calculated as all energy consumed during crop production and biofuel processing has been established. From Figure 4, it can be seen that the net energy created by wheat biomethane per hectare of crop is only 62.3% of theoretical energy. The net energy created from maize silage and grass silage stand at 78.3% and 80% respectively. This would suggest that the use of cereals in biomethane production is not as efficient as forage crops as wheat

consumes 37.7% of the energy it creates, while maize and grass silage consume only 21.7% and 20% respectively.

It is interesting to note that eliminating plastic covering in the production of maize in Ireland can improve crop energy consumption by almost 6.2% but the subsequent reduction in yield would result in a 16.3% reduction in net energy created.



**Figure 4: Biomethane – net energy (GJ/ha)**

It is important to note the energy comparison of each crop in relation to land area requirements. For a typical Irish car travelling 16,376km per annum with a fuel efficiency of 8.7m<sup>3</sup>/100km (Volvo cars, 2004), wheat, maize silage and grass silage from biomethane can fuel 1.28, 3.64 and 3.65 cars per hectare respectively (Börjesson and Mattiasson, 2008, CSO, 2009, Volvo cars, 2004).

## 6. Conclusion

In conclusion, it can be seen that the energy balance of forage crops from biomethane in Ireland is quite impressive. Ireland's ability to produce high yielding grass silage with little effort would suggest that it is the better of the two forages for biomethane production. The energy balance of grass silage can be improved further if some synthetic nitrogen is replaced; this can be achieved by utilising the digestate created from the anaerobic digestion process as a synthetic fertiliser supplement.

The overall result is that biomethane from grass silage is the most suitable feedstock on an energy balance basis. On a practical level, present agricultural knowledge and practices in Ireland are already well-equipped in efficient production of high yielding perennial ryegrasses and would suggest that increasing grass silage production in Ireland would be easily accommodated.



## 7. References

- Angarita, E. E. Y., Lora, E. E. S., da Costa, R. E. & Torres, E. A. (2009) The energy balance in the Palm Oil-Derived Methyl Ester (PME) life cycle for the cases in Brazil and Colombia. *Renewable Energy*, 34, 2905-2913.
- Börjesson, P. & Mattiasson, B. (2008) Biogas as a resource-efficient vehicle fuel. *Trends in Biotechnology*, 26, 7-13.
- Briassoulis, D. (2007) Analysis of the mechanical and degradation performances of optimised agricultural biodegradable films. *Polymer Degradation and Stability*, 92, 1115-1132.
- Bruni, E., Jensen, A., Pedersen, E. & Angelidaki, I. Anaerobic digestion of maize focusing on variety, harvest time and pretreatment. *Applied Energy*, 87, 2212-2217.
- Crowley, J. G. (1998) Teagasc, The Irish Agriculture and Food Development Authority, *Improving Yield and Quality of Forage Maize*.
- CSO (2009) Central Statistics Office Ireland, Business sector, Transport, Road traffic volumes, Average Kilometres Travelled by Private Car (Kilometres) available on <http://www.cso.ie/px/pxeirestat/Dialog/Saveshow.asp>
- Curtin, J. (2010) Barryroe Co-operative, Crop/Tillage advisor.
- Directive 2003/30/EC of the European Parliament and of the Council of 8 May 2003 on the promotion of the use of biofuels or other renewable fuels for transport 'Biofuels Directive'. *Official Journal of the European Parliament L 123 (42)*.
- Directive 2003/96/EC of the European Parliament and of the Council of October 2003 on the restructuring the Community framework for the taxation of energy products and electricity (2003)
- Directive 2009/28/EC of the European Parliament and of the Council of 23 April 2009 on the Promotion of the Use of Energy from Renewable Sources and Amending and Subsequently Repealing Directives 2001/77/EC and 2003/30/EC. *Official Journal of the European Union*, 140, 16-62.
- European Commission (2008 <19 final>) Proposal for a Directive of the European Parliament and of the Council on the promotion of the use of energy from renewable sources. *COM (2008) 19 final, Brussels, Belgium*.
- European Commission (2008 <30 final>) Communication from the Commission to the European Parliament, the Council, the European Economic and Social Committee and the Committee of the Regions '20 20 by 2020, Europe's climate change opportunity'.
- Gerstenberg, D. (2010) Project Manager agriKomp GmbH.
- Green, M. (1987) Energy in pesticide manufacture, distribution and use. *Energy in plant nutrition and pest control*, 7, 0-444.
- Hildebrandt, R. (2010) Project Manager MT Biomethan, Ludwig-Elsbett-Strabe 1 27404 Zeven Germany.
- Jayas, D. & White, N. (2003) Storage and drying of grain in Canada: low cost approaches. *Food control*, 14, 255-261.
- Jungbluth, N., Chudacoff, M., Dauriat, A., Dinkel, F., Doka, G., Faist Emmenegger, M., Gnansounou, E., Kljun, N., Schleiss, K. & Spielmann, M. (2007) Life cycle inventories of bioenergy.ecoinvent report.

- Jury, C., Benetto, E., Koster, D., Schmitt, B. & Welfring, J. (2010) Life Cycle Assessment of biogas production by monofermentation of energy crops and injection into the natural gas grid. *Biomass and Bioenergy*, 34, 54-66.
- Kallivroussis, L., Natsis, A. & Papadakis, G. (2002) RD--Rural Development: The Energy Balance of Sunflower Production for Biodiesel in Greece. *Biosystems Engineering*, 81, 347-354.
- Kwabiah, A. (2004) Growth and yield of sweet corn (*Zea mays* L.) cultivars in response to planting date and plastic mulch in a short-season environment. *Scientia Horticulturae*, 102, 147-166.
- Loomis, R. & Lafitte, H. (1987) The carbon economy of a maize crop exposed to elevated CO<sub>2</sub> concentrations and water stress, as determined from elemental analyses. *Field Crops Research*, 17, 63-74.
- Maier, D. & Bakker-Arkema, F. (2002) Grain Drying Systems, *Facility Design conference of the Grain Elevator (28-31, 2002. St. Charles, Illinois, USA)*. GEAPS FDC.
- Mecmar Batch Grain Driers (2010) Model S55F 440t/24hr, www.mecmar.co.uk (Accessed 10 August 2010).
- Mikkola, H. & Ahokas, J. (2010) Indirect energy input of agricultural machinery in bioenergy production. *Renewable Energy*, 35, 23-28.
- Murphy, J. & McCarthy, K. (2005) The optimal production of biogas for use as a transport fuel in Ireland. *Renewable Energy*, 30, 2111-2127.
- Murphy, J. & Power, N. (2009) Technical and economic analysis of biogas production in Ireland utilising three different crop rotations. *Applied Energy*, 86, 25-36.
- Murphy, J. D., McKeogh, E. & Kiely, G. (2004) Technical/economic/environmental analysis of biogas utilisation. *Applied Energy*, 77, 407-427.
- Nizami, A. & Murphy, J. What type of digester configurations should be employed to produce biomethane from grass silage? *Renewable and Sustainable Energy Reviews*, 14, 1558-1568.
- O'Kiely, P. (2009) "Fuelling Ireland's future" *Irish BioEnergy Association conference*, Roganstown Hotel, Swords, Co. Dublin Thurs. 22 January, 2009.
- Patel, M., Bastioli, C., Marini, L. & Würdinger, E. (2002) Environmental assessment of bio-based polymers and natural fibres. *Life-cycle assessment of bio-based polymers and natural fibres. Chapter in "biopolymers*, 10.
- Power, N. (2007) The potential for CH<sub>4</sub> enriched biogas as a transport fuel in Ireland. *PhD submitted to HETAC*.
- Schnepf, R. (2006) CRS Report for Congress, European Union biofuels policy and agriculture: an overview, Order Code RS22404.
- Smyth, B., Murphy, J. & O'Brien, C. (2009) What is the energy balance of grass biomethane in Ireland and other temperate northern European climates? *Renewable and Sustainable Energy Reviews*, 13, 2349-2360.
- Sukup Manufacturing Company (2010) Bin Operational Manual - Commercial, Stiffened, Farm & Hopper (www.sukup.com/Additional%20pdfs/BinOperationManual.pdf) (Accessed 18 August 2010).
- Tabatabaeefar, A., Emamzadeh, H., Varnamkhasti, M. G., Rahimizadeh, R. & Karimi, M. (2009) Comparison of energy of tillage systems in wheat production. *Energy*, 34, 41-45.

Tzilivakis, J., Warner, D. J., May, M., Lewis, K. A. & Jaggard, K. (2005) An assessment of the energy inputs and greenhouse gas emissions in sugar beet (*Beta vulgaris*) production in the UK. *Agricultural Systems*, 85, 101-119.

Volvo cars (2004) Volvo V70 methane/petrol ([www.volvoclub.org.uk/tech/CNG-MY2002.pdf](http://www.volvoclub.org.uk/tech/CNG-MY2002.pdf)) (Accesses 19 August 2010).

West, T. O. & Marland, G. (2002) A synthesis of carbon sequestration, carbon emissions, and net carbon flux in agriculture: comparing tillage practices in the United States. *Agriculture, Ecosystems & Environment*, 91, 217-232.



# Finite Element Modelling of the Response of Hollow Core Floors to Concentrated Linear and Patch Loadings

D.F. Hodge, B.D. O'Rourke & J.J. Murphy  
Department of Civil, Structural & Environmental Engineering, Cork Institute of  
Technology, Bishopstown, Cork, Ireland.  
david.hodge@cit.ie

## Abstract

Precast concrete hollow core floors consist of a number of adjacent hollow core units grouted together using a mortar or concrete joint. A concentrated load applied on an individual unit can be transversely distributed through the joints to the adjoining slabs. This load transfer mechanism reduces the actual load carried by the loaded unit. Tests previously carried out have relied on the displacement response of the floor to calculate the load sharing characteristics of the floor, as experimentally, this is the most straightforward approach. Reaction and stress responses have for the most part been overlooked. Graphs of load distribution factors are incorporated in the current standards and guidelines, such as BS EN 1168:2005 (British Standards Institution, 2005), which have been determined based on the theory of elasticity, and the Fédération Internationale de la Précontrainte (FIP) recommendations (Fédération internationale de la précontrainte, 1988), which have been based both on analytical calculations and test data. Comparisons of the load distribution factors for linear loading can have a variation of up to 15% in the factors obtained from both sources.

This paper describes the use of the structural analysis software LUSAS (version 14.3-9) to create 3D finite element (FE) models, to simulate the transverse load sharing over a number of precast hollow core floor slabs. An extensive FE modelling study has been conducted on many slab sections under various loading conditions. Both reinforced and prestressed models were generated and a non-linear concrete material model was used to model the precast units and the joints. Experimental testing has been carried out on individual precast slabs to validate the FE models. Results for displacements, reactions and stresses have been obtained from the FE analyses. The theoretical and FE analyses results have been compared, and graphical results presented.

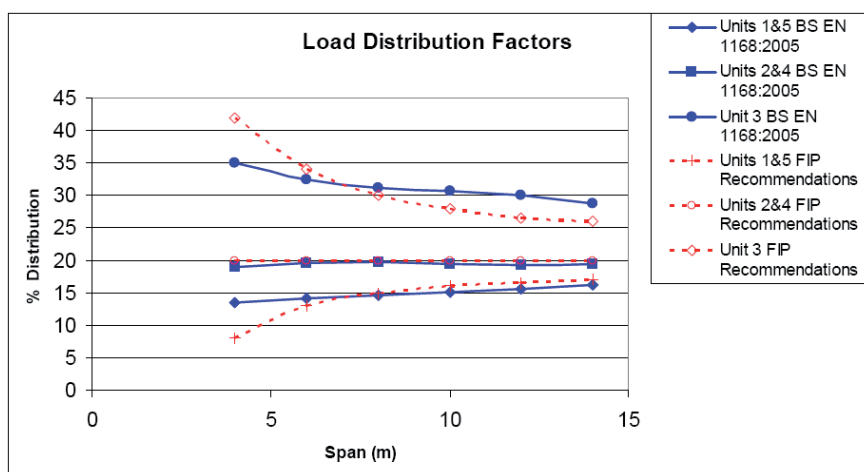
## Keywords

Finite element modelling, Hollow core, Load sharing, LUSAS

## 1. Introduction

Precast concrete hollow core slabs are used extensively as structural flooring and roofing systems within modern buildings. Their use offers advantages when compared to in-situ construction, such as high quality of product, reduced construction times and better economy primarily due to their manufacture in a off-site controlled environment. The units may be prestressed or reinforced, generally spanning as a simply supported element and of 1.2m nominal width. Adjacent units are grouted together with mortar or concrete to create the floor or roof slab.

Structural concrete topping can be added to improve the floor stiffness and may be included in the design calculations. In this paper, load sharing is defined as the ability to transfer load from the loaded slab; thus a higher load sharing indicates that a greater proportion of the load is transferred to the unloaded units. The load sharing characteristics of the hollow core units can be utilised, to enable the design of a more structurally efficient section size by reducing the load being applied to the loaded unit. This in turn gives economic and geometric advantages with a reduction in both the cost and the depth of the finished floor. Figure 1 shows a graph of the percentage of load carried by each of the five units when a line load is applied to the centre one using BS EN 1168 and the FIP recommendations. Experimental and analytical research has been carried out in the past by Stanton (Stanton, 1987, Stanton, 1992), Moss (Moss, 1995), and Song (Song et al., 2009), Hodge (Hodge et al., 2010).

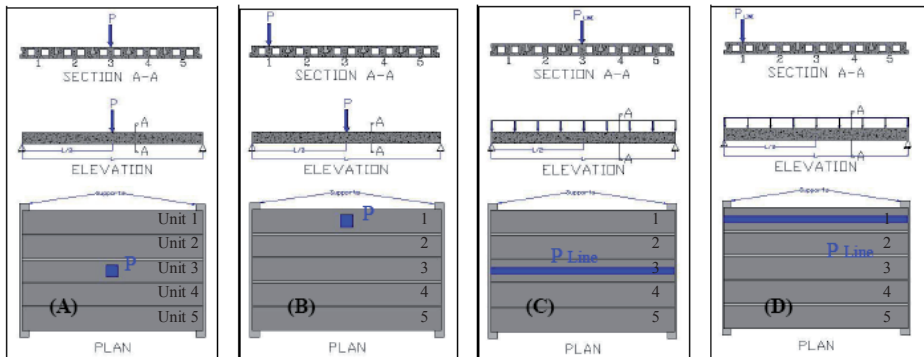


**Figure 1: Percentage load distribution factors**  
(See Figure 2 for locations of units 1 to 5)

## 2. Scope and Objective

This paper describes the use of the structural analysis software LUSAS (Version,14.3-9) to create 3D solid continuum finite element models, to simulate the transverse load sharing of a number of precast hollow core floor units joined together using a mortar / concrete infill. Stanton (1992) carried out similar work with the units being modelled as plates connected by rotational hinges. Stanton stated “To model every void explicitly would make the analysis too cumbersome”. With developments in computing it is now possible to model the units and the joint with their actual geometry. An extensive finite element (FE) modelling study has been conducted on a range of unit sections under various loading conditions. Within FE analyses there are four primary types of models that can be created; 2D, Quasi 3D, 3D, and 3D solid volumes. 3D Volume modelling whilst the most complex, is the most suitable type for these analyses. All the FE models created consist of five hollow core units joined along adjacent edges using a mortar / concrete infill. Figure 2 show how the units are

numbered throughout this paper along with the loading arrangement. Four different load cases have been used in each individual model. These are: (A) Patch load on unit 3, (B) Patch load on unit 1, (C) Line Load on unit 3 (Representing a wall load) and (D) Line load on unit 1.



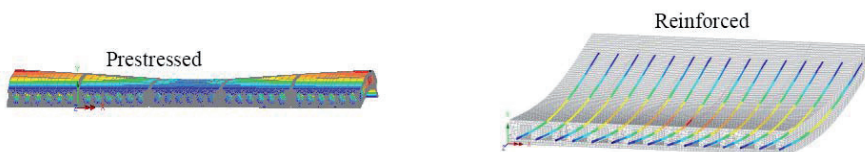
**Figure 2: Load case diagrams**

Both reinforced and prestressed models were generated and a non-linear concrete model was used to represent both the precast units and the joint material. Experimental testing has been conducted on precast reinforced slabs to validate the FE models. The test results presented by previous research (Moss, 1995) have been used to establish confidence in the models. In total 28 different models were created, each comprising five different sections of nominal width 1.2m. The depths of the units were 125mm, 150mm, 200mm, 250mm, and 300mm. Unit 1

The objective was to study reaction and stress response and to establish how conservative the current guidelines are, and whether more economical designs can be achieved using the results from FE analyses in situations where load sharing prevails. The theoretical and FE analyses along with experimental results have been compared and graphical results are presented.

### 3. LUSAS Finite Element Analysis

Three dimensional solid volume modelling of this arrangement of hollow core units is an involved process. A number of prestressed and reinforced units was modelled to simulate the load sharing of hollow core units. Figure 3 shows the displacement of a prestressed hollow core floor along with the stress profile of the reinforcement within a reinforced floor.



**Figure 3: Prestressed and reinforced models**

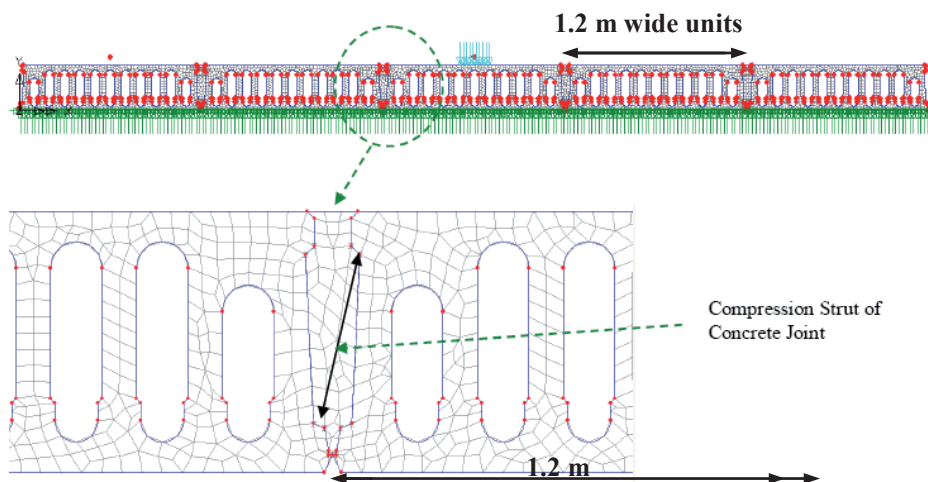
The prestressed models were stressed using the “Pre-stress Wizard” facility within LUSAS. Within the wizard, properties such as creep, shrinkage, slippage, etc. can be entered. The lines representing the tendons need to be drawn in their location within the units and a solid pre-stressing wizard chosen. When creating the reinforced models, the lines representing the reinforcement must also be constructed as lines representing the volumes. This in effect means splitting the unit into two joined volumes along the reinforcement layer. This can cause considerable difficulties when meshing the models as the number of elements being created becomes extremely large. 3D solid bar elements were used to model the reinforcement. In the prestressed and reinforced models, the concrete was represented using a non-linear concrete material model. This concrete model can represent both the tensile and compressive strength of the concrete along with concrete crushing and cracking characteristics. As a result of the large amount of time required to create and compute these models it was decided to create the same model geometry without pre-stressing tendons or reinforcement and with a linear elastic concrete. It was found that while the displacements and stresses were different from the reinforced / prestressed models, the load sharing percentages obtained were the same. This established that for this study, the modelling could be undertaken using linear elastic concrete units without pre-stressing or reinforcement. Table 1 shows the models that have been created. To establish confidence in the models each of the units was first modelled individually before being joined and the displacements and stresses checked using traditional hand calculations. The maximum error found during this process was less than 0.5%. In LUSAS (Version 14.3-9) there is a limit of approximately 250,000 elements. During the meshing process aspect ratios have to be taken into consideration. The aspect ratio is the ratio of the longest side of the element to the shortest. Generally a high aspect ratio within an element may result in inaccurate results, therefore LUSAS recommends that the aspect ratio be kept below 10. These limits caused considerable difficulties when working with the larger spans and careful consideration had to be given to the mesh density and element type and size.

Span	4m	6m	8m	10m	12m	14m
150mm x 1200mm x 11core Echo	X	X	X	X	X	X
200mm x 1200mm x 11core Echo	X	X	X	X	X	X
250mm x 1200mm x 7core Ducon	X	X	X	X	X	X
300mm x 1200mm x 11core Echo	X	X	X	X	X	X
250mm x 1200mm x 6core Echo Prestressed		X		X		
150mm x 1200mm x 9core Moss Reinforced		X				
125mm x 400mm x 2core CIT Reinforced	3m span					

**Table 1: Finite Element models created**

To model the hollow core units and the joints a cross section was first drawn in AutoCAD and then imported into LUSAS. Within LUSAS, surfaces were created and then extruded to form volumes. 3D solid continuum elements called HX8M were used to mesh both the hollow core units and the concrete joints. These elements contain eight nodes and are of hexahedral shape. A consistent mesh density should be sought with perfect cube elements being formed, but with the curved voids this is impossible to achieve using any element type as none of the element types can be curved. The mesh was refined until a satisfactory mesh consistency was formed as shown in Figure 4. A linear concrete material property was then assigned to both the units and the joints.





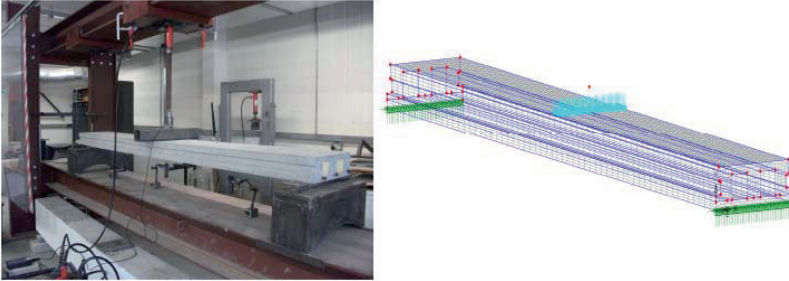
**Figure 4: Image of volume mesh**

The hollow core units and the concrete joints were joined together using joint elements JNT4. These joint elements join all nodes along a surface or line using springs. To prevent independent movement between the hollow core unit contact surfaces and the concrete joints' contact surfaces, these springs were assigned a very high stiffness value. To facilitate lateral transfer of the shear loads and represent the compression strut of the concrete joint, the joint elements were only assigned to the surfaces inclined to the horizontal. Supports were provided using a pinned support on one end and a roller support on the other. Point loads were applied as patch loads on a 200mm x 200mm patch, simulating a column load. Line loads were also applied as patch loads 215mm wide and running the length of the span, simulating a wall load.

#### 4. Experimental Testing

A number of reinforced concrete units 125mm x 400mm x 2core was constructed and tested in the Heavy Structures Testing Laboratory at Cork Institute of Technology. The first test was undertaken on a single unit with a single load applied at centre span as shown in Figure 5. This was modelled in LUSAS as a reinforced model with a non-linear concrete material property assignment. The results for deflection at centre span for both the test and the model were in close agreement. The second test involved joining five slabs together using a mortar infill and applying a linear load on the centre slab as in load case (C), shown in Figure 2. Again the displacement results obtained from the test, and the FE modelling, were in broad agreement. Finally, the floor section that was taken from Moss (1995) was modelled in LUSAS and the results compared with the results obtained from that paper. It was not possible to model the Moss floor section completely accurately because the complete design information was not included in the paper. However, the load sharing percentages calculated from the paper and the LUSAS model were found to be in broad agreement.

The present work is primarily an analytical approach, which is to be followed by testing of a full scale floor deck comprising of five 1200 wide by 200mm deep units. The four load cases outlined in Figure 1 will be investigated and measurements of displacements and reactions recorded and then compared to the corresponding FE model. The floor deck will then be covered with a composite structural screed to establish what effect this will have on the load sharing characteristics.

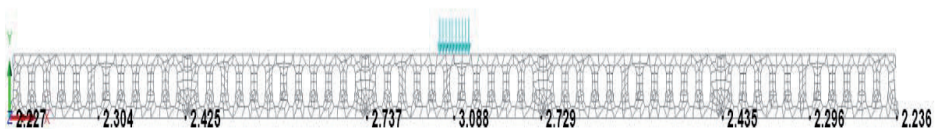


**Figure 5: Image of single unit being tested along with a LUSAS model of the unit**

## 5. LUSAS Results

The results presented in this paper are for a 200 x 1200 x 11 core floor consisting of five units. The floors considered have spans from 4m to 8m. This is the normal range of spans for which these units would be used. This floor arrangement is being used in the full scale testing, which is currently being carried out. In this paper load sharing is defined as the ability to transfer load from the unit to which it is directly applied on to its neighbouring units. The load sharing behaviour of the joined units was calculated using the average displacement, stress and support reactions of each unit. To obtain the stress and displacement results a 2D slice was taken through the 3D models at centre span and the displacements and stresses of selected nodes displayed. Figure 6 shows the stress 2D slice for a line load on a 200mm x 1200mm x 11 core Echo section of span 4m.

BS EN 1168:2005 gives guidance that the load being carried by the loaded slab should be modified by multiplying the percentage of the load on the directly loaded member by 1.25 if a composite screed is not added. The FIP recommendations include this 25% in the graphs which can be excluded if a screed is used. For clarity all analysis was done assuming no screed.



**Figure 6: 2D stress slice**

## 5.1. Load Case (A) Point Load on Centre Unit

Figure 6 shows the graphs from BS EN 1168:2005, FIP recommendations and the graphs created from the LUSAS results for reaction, displacement and stress. The upper line in the first five graphs represents the percentage load being taken on the loaded unit, with the lower lines representing the loads being transferred to the adjoining units. The upper lines in graphs (A) to (E) are the critical lines for design as the loaded units will always be carrying the largest percentage of the load. Graph (F) represents all the upper lines from graphs (A) to (E). Within these graphs it can be seen that different results are obtained from each response considered. The displacement response gives the greatest load sharing with the results from the FIP being the most conservative. The stress results correspond closely with BS EN 1168:2005. Graph (F) shows that for a span of 4m there is a difference of 20% in the load being applied to the loaded unit with a difference of 15% for a span of 8m.

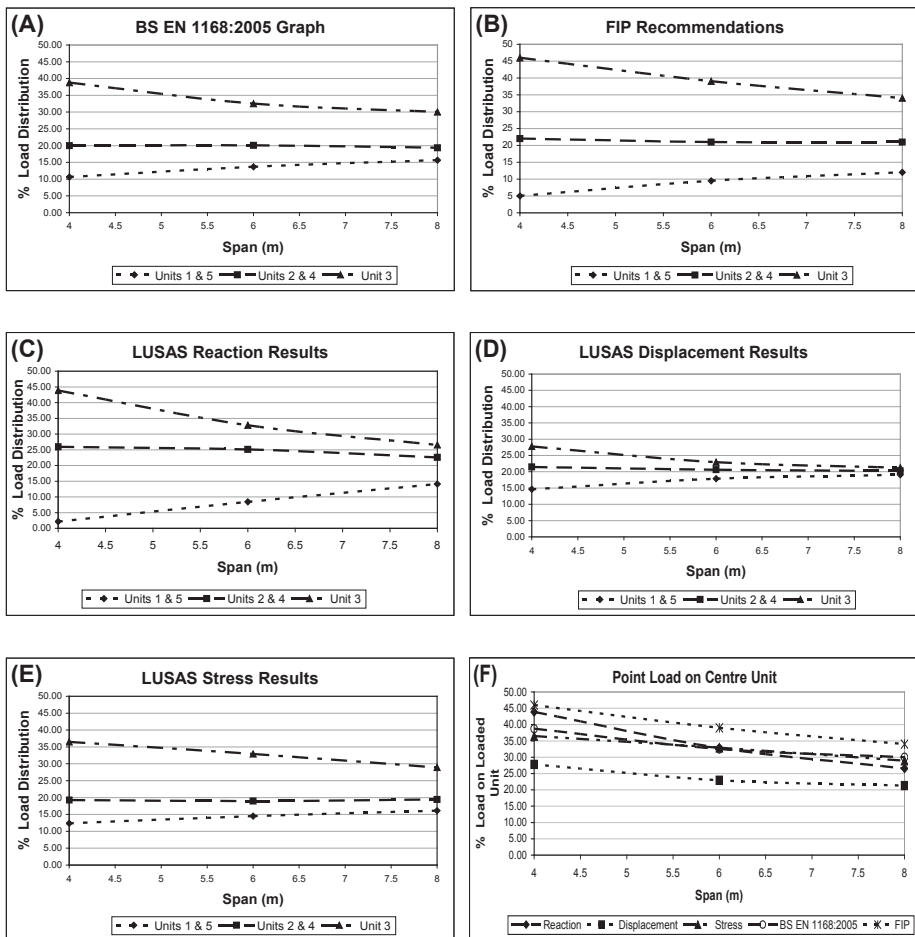


Figure 6: Load Distribution graphs for a point load on unit

## 5.2. Load Case (B) Point Load on Edge Unit

Figure 7 represents the load distribution results for a point load applied on the edge unit in load case (B). In this graph it can be clearly seen that there is no load transfer occurring when considering the reaction response. The reaction of the loaded unit goes above 100% and it is noted that uplift is occurring in units 3, 4 and 5. This suggests that when considering loads for shear design there should be no load transfer assumed for point loads applied to the edge unit.

The stress results correspond most closely with BS EN 1168:2005 and the displacement results give the greatest load transfer. FIP results would be considered the most conservative giving the least load transfer when compared to stress, displacement and BS EN 1168:2005 results.

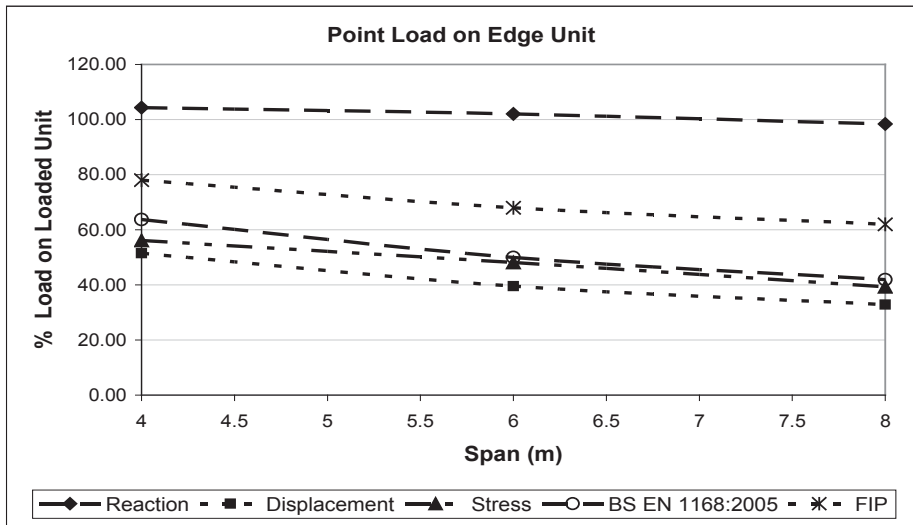


Figure 7: Load Distribution graph for a point load on unit 1

## 5.3. Load Case (C) & (D) Linear Load on Centre Unit and Edge Unit

Figure 8 represents the load distribution results for a linear load applied on the centre unit in load case (C). In this load case it can again be seen that the reaction results are far higher than any of the other results. This puts these results well above any of the design guidance given in BS EN 1168:2005 and the FIP recommendations. The stress and displacement results in this load case are for all practical purposes the same and are below both the FIP and BS EN 1168:2005 results suggesting that there may be scope for a more efficient design in relation to stresses and displacement.

Figure 9 represents the load distribution results for a linear load applied to the edge unit. As with a point load applied on the edge unit, these results suggest that there is no load transfer taking place in relation to the reaction response. The reaction of the loaded unit is going above 100% and uplift is occurring in units 3, 4 and 5. In this load case it is suggested that in relation to shear design that no load transfer is

assumed. The stress and displacement results in this load case are similar and are below both the FIP and BS EN 1168:2005 results suggesting that there may be scope for a more efficient design in relation to stresses and displacement.

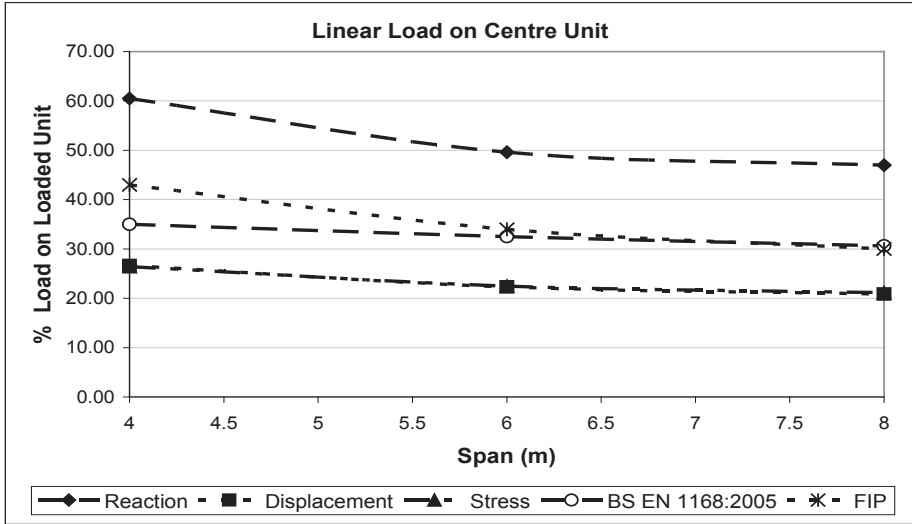


Figure 8: Linear Load on Centre Unit

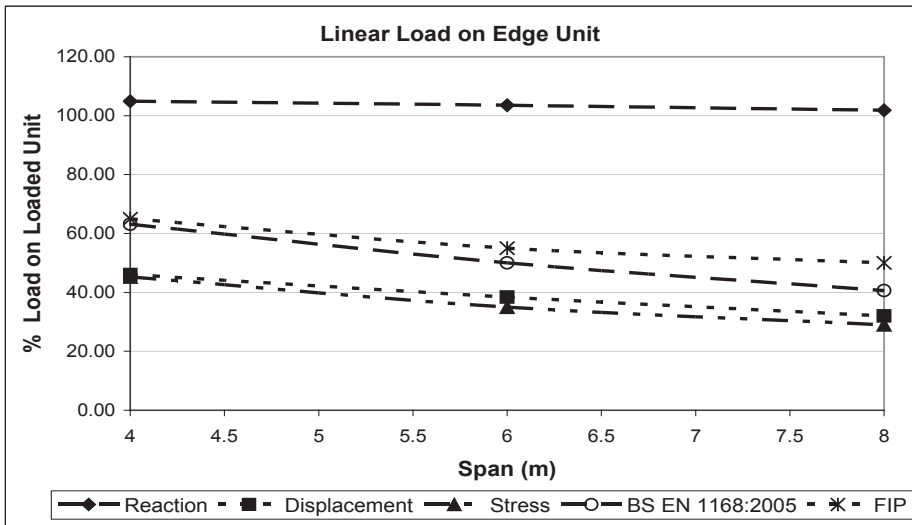


Figure 9: Linear Load on Edge Unit

## 6. Conclusion

From the finite element analyses carried out and the test data obtained in this study, comparisons with the guidance from BS EN 1168:2005 and the FIP recommendations, the following conclusions can be made.

(1) Finite element modelling can be used to successfully model the transverse load sharing between hollow core floor slabs. It has been shown to provide consistently correct results in the cases of prestressed or reinforced hollow core units. Finite element modelling is effective as changes in span, load case, and section size can be modelled, and large amounts of reliable data collected.

(2) The load sharing provided by both BS EN 1168:2005 and the FIP recommendations are conservative in comparison with the finite element analysis displacement results for linear load cases. While the design guidance given is conservative, it is possible that more economical designs could be achieved by the use of finite element modelling.

(3) Shear design needs to be carefully considered when using load distribution graphs. It is suggested that in cases of loads being applied to the edge unit, no load transfer should be assumed and the full load should be used in shear calculations. Where loads are being applied to the centre span modified graphs should be considered for these load cases.

## 7. References

British Standards Institution (2005) BS EN 1168:2005. Precast concrete products - Hollow core slabs.

Federation Internationale de la Precontrainte (1988) Precast prestressed hollow core floors. Thomas Telford.

Hodge, D. F., O'Rourke, B. D. & Murphy, J. J. (2010) Finite Element Modelling of Transverse Load Sharing Between Hollow Core Floor Slabs. Bridge, Concrete and Infrastructure Research in Ireland. Cork, ISBN No. 978-0-9542973-3-6.

Moss, R. M. (1995) Load testing of hollow plank concrete floors. *The Structural Engineer*, 73, 161-168

Song, J.-Y., Elliot, K. S., Lee, H. & Kwak, H.-G. (2009) Load Distribution Factors for Hollow Core Slabs with In-situ Reinforced Concrete Joints. *International Journal of Concrete Structures and Materials*, 3, 63-69.

Stanton, J. F. (1987) Proposed Design Rules for Load Distribution in Precast Concrete Decks. *Structural Journal*, 84, 371-382.

Stanton, J. F. (1992) Response of Hollow-Core Slab Floors to Concentrated Loads. *PCI Journal*, 37, 98-113.

# Determination of moment-rotation curves for semi rigid steel end plate connections

N.Scollard, J.J.Murphy, B.D. O' Rourke

Department of Civil, Structural & Environmental Engineering,  
Cork Institute of Technology, Cork, Ireland  
e-mail: niall.scollard@cit.ie

## Abstract

Structural steel joints that are classified as semi-rigid behave differently to both fixed and pinned connections. They are often assumed to be pinned during the design process. There is a potential to take advantage of the partial rigidity of this type of joint to design a more economical frame.

The stiffness of the joint is an important property required to perform an analysis of the frame. The moment-rotation curve for a given joint provides both the joint stiffness and moment capacity. To determine the moment-rotation curve for a joint, a structural test has to be carried out; however it is not usually practical to carry out structural tests when at the design stage.

Several methods can be used to obtain an approximation of the moment-rotation curve; these vary in accuracy. Three of these methods have been examined in this paper: finite element modelling, the component method as used in EN 1993-1-8 and previously proposed analytical models.

## Keywords

Structural steel, joints, connections, moment-rotation, joint stiffness, moment capacity, EN 1993-1-8, structural testing

## 1. Introduction

Traditional steel design practice assumes joints are either fully rigid, providing full continuity of rotations and moments or fully pinned, which are incapable of transmitting moments and permit free rotation. The behaviour of most practical joints lies between these two types and such joints are usually referred to as “semi rigid” or “partially restrained”. The design code EN 1993-1-8 (NSAI, 2005) has established methods to take into account these types of joints.

There is a significant difference in the distribution of bending moments for a beam with pinned, semi-rigid, and fully rigid joints as shown Figure 1. When designing a steel frame if the joints are designed as semi-continuous, the size of steel beams can be reduced, while there may be a small increase in the sizes of columns. As beams generally comprise the greater portion of steel in a structure, a reduction in their size can give rise to a more economical design.

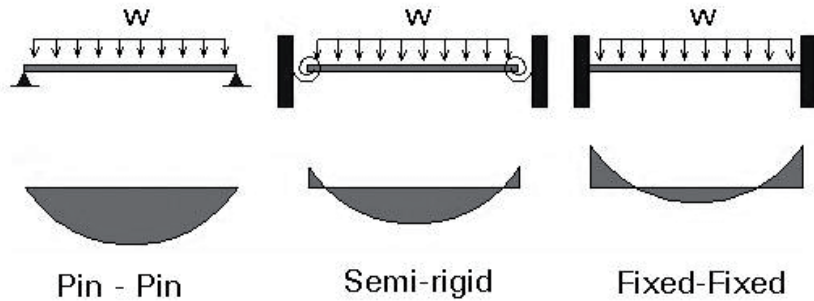


Figure 1: Distribution of moments for different joint types (Maguire, 1995)

## 2. Moment-rotation curve

Both the joint stiffness and joint strength can be observed from the moment-rotation curve. The moment capacity ( $M_{j,Rd}$ ) and the stiffness of the joint ( $k$ ), which is the slope of the moment-rotation curve can be seen in Figure 2. The moment-rotation curve will start as a straight line for the elastic region, the slope of this portion of the graph is referred to as the initial stiffness ( $S_{j,ini}$ ) in EN 1993-1-8 (NSAI, 2005).

In order to carry out a frame analysis that includes semi rigid joints, the stiffness of the joint needs to be determined.

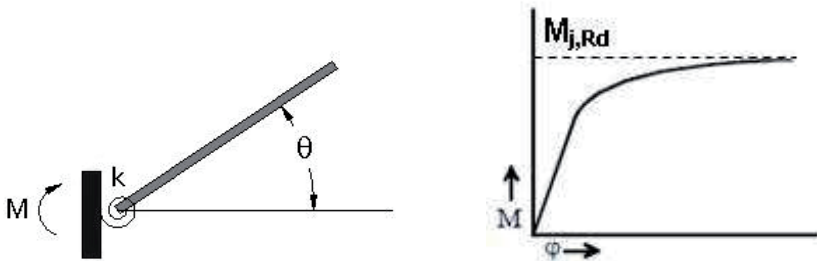


Figure 2: Moment-rotation curve (Maguire 1995)



### 3. Determination of moment-rotation curve by testing

The most straightforward way to determine the moment-rotation curve for a joint is to carry out a structural test. This provides an accurate representation of the actual behaviour of the joint.

Figure 3 shows the moment-rotation curves for a range of connections, which were obtained by carrying out such structural tests; it can be seen that different connection types provide different moment-rotation behaviours.

A series of tests has been planned and an initial test has been carried out with the results presented in Figure 4; the layout of the joint is shown in Figure 5, Figure 6 and Figure 7. As this test was of a preliminary nature, it was maintained within the elastic range so only the elastic portion of the moment rotation curve is presented as shown in Figure 4.

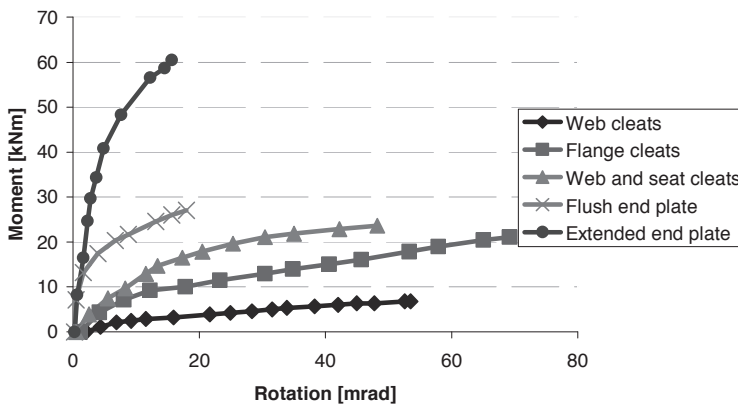


Figure 3: Moment-rotation curves for a variety of connections (ECCS 1992)

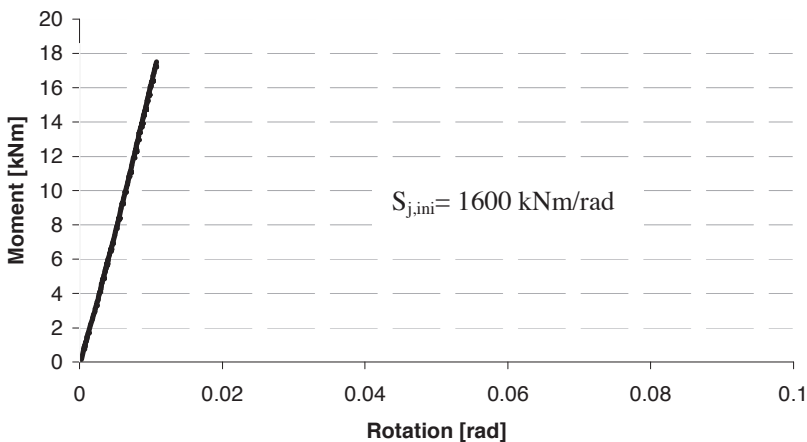
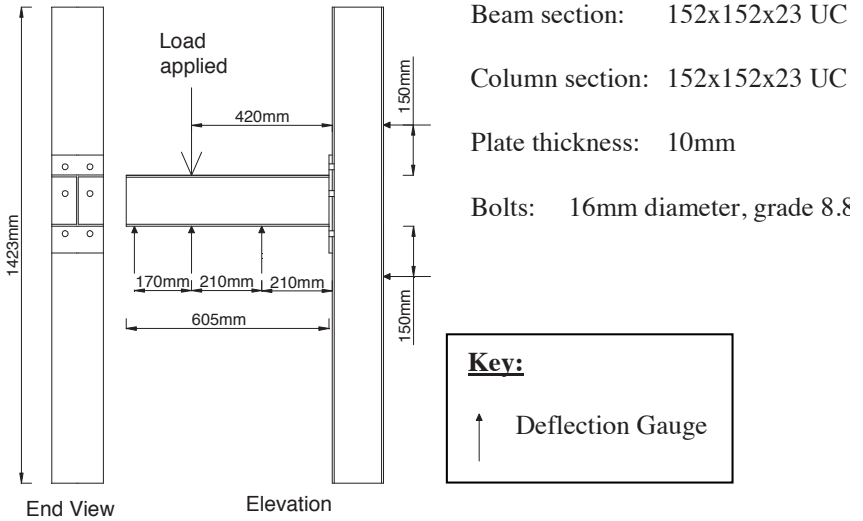
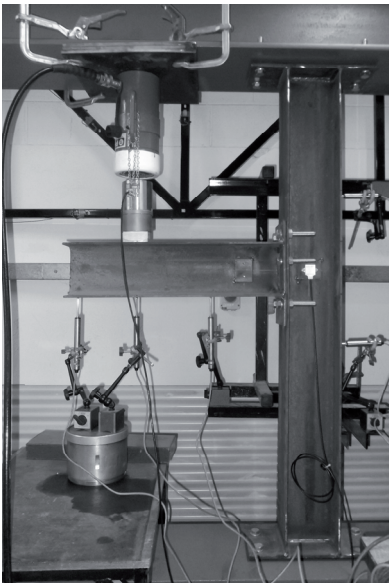


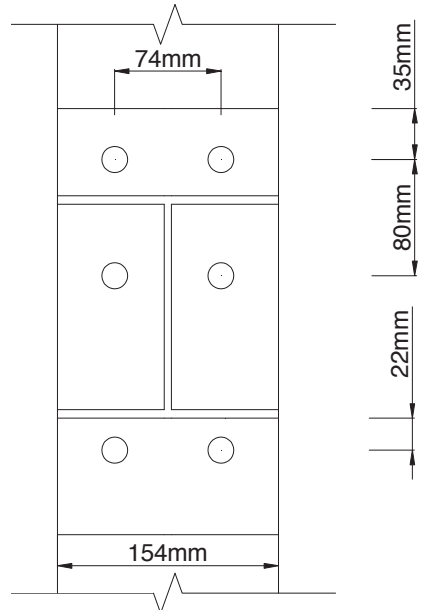
Figure 4: Moment-rotation curve for initial test



**Figure 5** Layout of initial test



**Figure 6:** Initial test

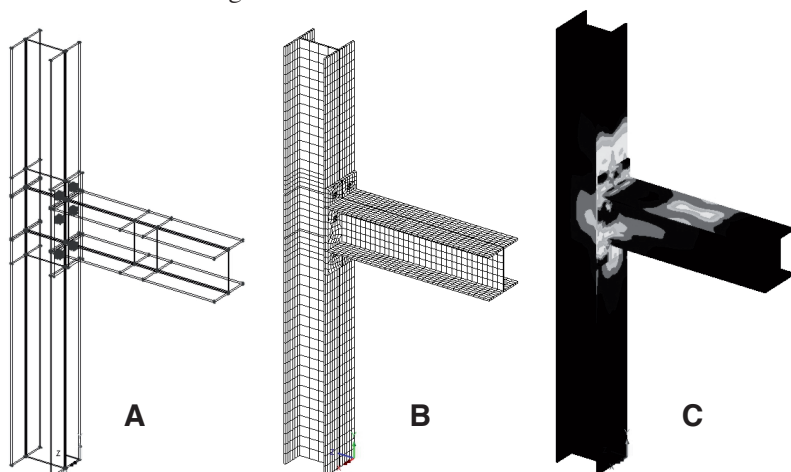


**Figure 7:** Bolt Layout

### Three dimensional finite element model

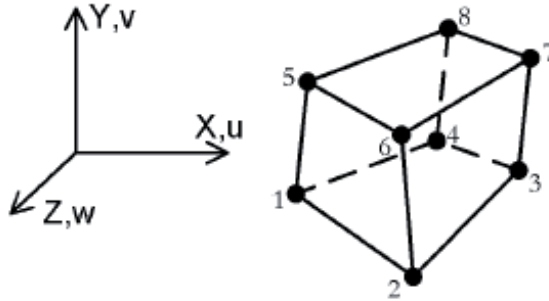
Three dimensional finite element modelling allows the user to create detailed models, which will accurately represent the actual behaviour of structural connections. This will allow the user to obtain similar results to an actual structural test at an early stage of the design process where structural testing is not feasible.

Models have been created for analysis in this paper using the software package LUSAS Version 14.3-0. A three dimensional finite element model of the initial connection that was tested as shown in Section 3 (Figure 5) of this paper has been prepared and is shown in Figure 8.



**Figure 8: LUSAS Model A) Model Geometry, B) Model Mesh, C) Stress Contours**

When creating the model, the beam, column and end plate were created as volumes. The model was constructed using volumes as it was found to provide the most accurate representation of the complex geometry. A hexahedral volume mesh was applied to the volumes; this assigns HX8M elements that contain eight nodes as shown in Figure 9. The mesh was optimised until the elements all had a low aspect ratio (the ratio of longest side to shortest side of a finite element). It is important to take the aspect ratio into account as the quality of results is affected when it becomes too large (LUSAS, 2008b). A von Mises material model with a uniaxial yield stress of  $300\text{N/mm}^2$  was used to represent the steel for the beam, column and end plate while a yield stress of  $640\text{N/mm}^2$  was applied to the bolts.

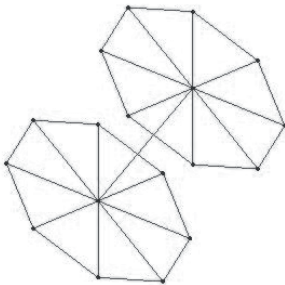


**Figure 9: HX8M element (LUSAS, 2008a)**

The portion of the model containing the beam and end plate were assigned to a separate group from the column and these two groups were then made unmergeable, which means they stay as separate items when they are placed together in contact. A slideline property was then assigned to the contact surfaces, which allows the contact of the end plate and the column flange to be modelled. The slideline property allows a gap to form where the tension flange of the beam meets the column flange and allows the compression flange of the beam to press against the column flange.

The bolts were modelled using the “cartwheel method” as used previously and recommended by the LUSAS team (Lindsey, 2007). This involved creating the bolts as a series of lines in the shape of a cartwheel as shown in Figure 10. The lines for the bolt heads were merged with the appropriate lines on the column flange/end plate to allow the bolts to hold the end plate and flange together.

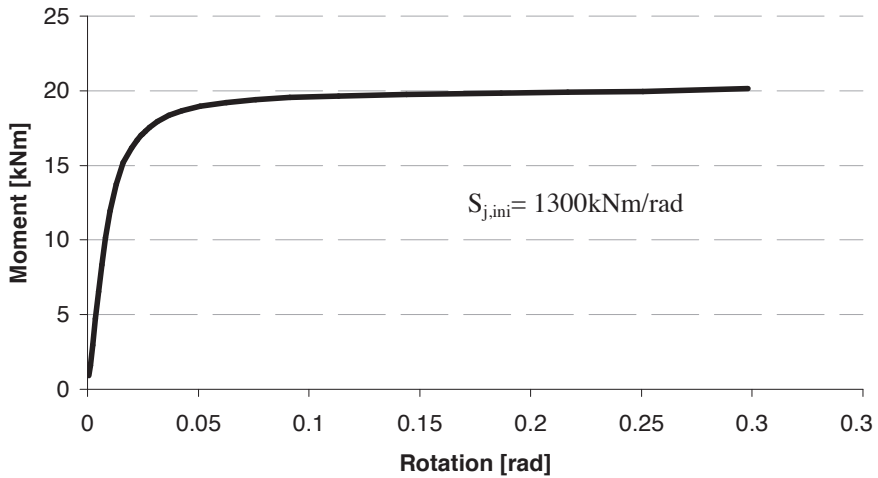
The model behaves in a similar fashion to the test that was carried out and as expected from the ultimate moment capacity calculations, the column flange yields first as shown in Figure 11 because it is the weakest component of the connection. The full moment-rotation curve for the model can be seen in Figure 12.



**Figure 10: Bolt cartwheel**

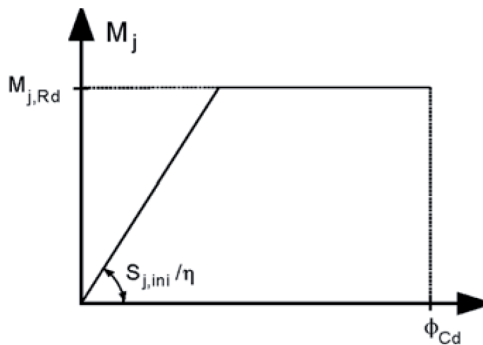


**Figure 11: Yielding of column flange (beam removed for clarity)**



**Figure 12: Moment-rotation curve for the test connection derived using the LUSAS finite element model**

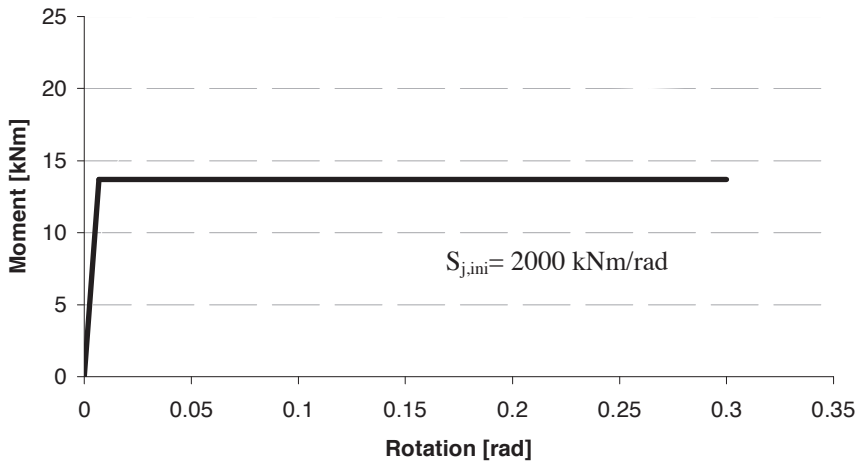
#### 4. Determination of moment-rotation curve using EN 1993-1-8



**Figure 13 Bi-linear moment-rotation curve as proposed by EN 1993-1-8**

A bi-linear moment-rotation curve can be derived using the procedure set out in EN 1993-1-8 to calculate the initial stiffness ( $S_{j,ini}$ ) and moment capacity ( $M_{j,Rd}$ ). To determine the moment-rotation curve for a connection using this method requires an intricate set of calculations.

The moment-rotation curve derived from EN 1993-1-8 for the test connection is shown in Figure 14.



**Figure 14: Moment-rotation curve for the test connection determined using EN 1993-1-8 procedure**

## 5. Analytical models

Equations have been proposed (Kozłowski et al. 2008) for various joint types to determine a lower bound moment-rotation curve that can be used as a rule of thumb for the designer, significantly reducing the amount of work required.

Equations are provided for both the moment capacity ( $M_{Rd}$ ) and initial stiffness ( $S_{j,ini}$ ), with variables relating to connection properties such as; beam depth, column depth, plate thickness and bolt size.

The relevant equations for an extended steel end plate connection are presented here as Eq.1 and Eq.2.

$$M_{Rd} = (7.4)(10^{-5})(h_c^{0.62})(h_b^{1.2})(t_p^{0.4})(d^{0.85}) \quad \text{Eq.1}$$

$$S_{j,ini} = (1.5)(h_c^{0.44})(h_b^{1.2})(t_p^{0.35})(d^{0.005}) - 19211 \quad \text{Eq.2}$$

where:

$h_c$  is the depth of the column

$d$  is the diameter of the bolt

$h_b$  is the depth of the beam

$t_p$  is the thickness of the plate

Eq.2 does not provide a reliable value for  $S_{j,ini}$  using the configuration of the initial test as the section sizes are outside the boundary limits; as a result of this only the moment capacity as derived from Eq.1 is shown in Figure 15.

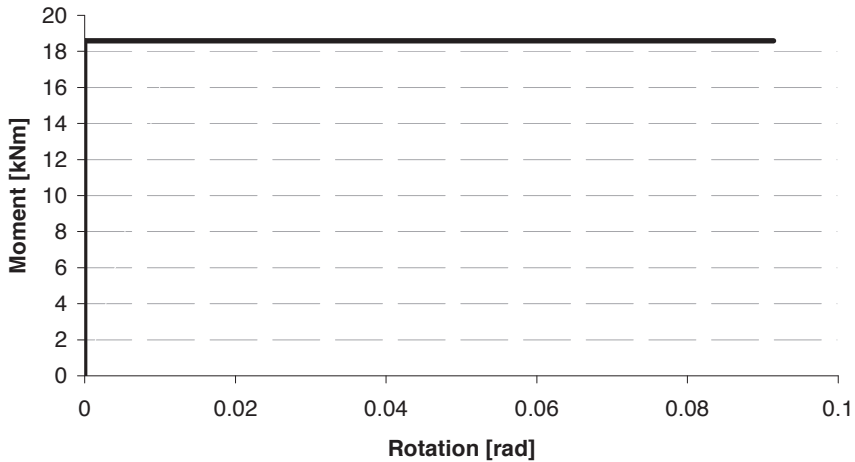


Figure 15: Moment-rotation curve for the test connection derived using analytical model

## 6. Conclusions and recommendations

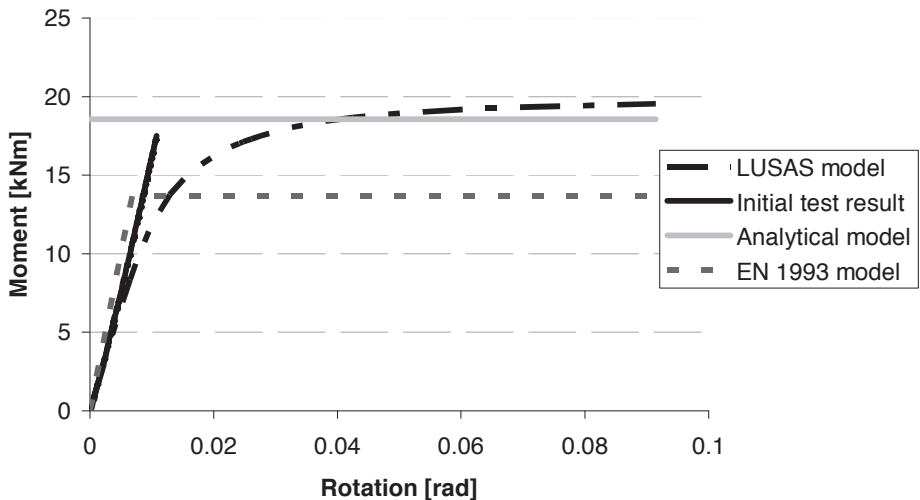


Figure 16: Comparison of four methods

A comparison of the initial test result and the three other methods is presented in Figure 16. It can be seen that both the LUSAS model and EN 1993-1-8 model provide a similar initial stiffness to the test and the analytical model does not.

As the initial test was maintained within the elastic range no value for the moment capacity of the connection was found from testing. It can be seen from Figure 16 that the EN 1993-1-8 model and the analytical model both yield at a lower moment than the LUSAS model, which is as expected taking into account that factors of safety are built into the formulae for steel design.

It is intended to carry out further testing and modelling for a series of different connection types, which will provide a broad spectrum of results and identify if limitations are present with each method.

## 7. References

- ECCS, 1992. *Analysis and design of steel frames with semi-rigid joints*, European Convention for Constructional Steelwork.
- Kozłowski, A., Kowalczyk, R. & Gizejowski, M., 2008. Estimation of the initial stiffness and moment resistance of steel and composite joints. In CTBUH 8th World Congress 2008.
- Lindsey, J., 2007. *Moment-Rotation Behavior of Extended End-Plate connections Under Cyclic Loading*. University of Kansas.
- LUSAS, 2008a. *Element Reference Manual*, LUSAS.
- LUSAS, 2008b. *Modeller Reference Manual*, LUSAS.
- Maguire, J., 1995. FEMCI Book - Notes on Semi-Rigid Connections. Available at: <http://femci.gsfc.nasa.gov/semirigid/index.html> [Accessed November 24, 2010].
- NSAI, 2005. *EN 1993-1-8, Eurocode 3: Design of steel structures - Part 1-8: Design of joints*, National Standards Authority of Ireland.



# Fit For the Future – a Semiautomatic Growing Ontology to Answer University Needs

R. Böving<sup>12</sup>, U. Bleimann<sup>1</sup>, C. Wentzel<sup>1</sup>, P. Walsh<sup>2</sup>

<sup>1</sup> University of Applied Sciences Darmstadt, Darmstadt, Germany

<sup>2</sup> Cork Institute of Technology, Cork, Ireland

e-mail: roland@boeving.net

## Abstract

Semantic technologies are an important tool for developing structured knowledge, for linking all types of content sources and making them available for evaluation. Knowledge is thereby developed through a network of topical terms, which, in themselves, are interrelated. The academic environment poses a special challenge for semantic knowledge development as its topic environments are often heterogenic and expand rapidly. The essential question is: Which topics are the focus of students and university staff and how can access to the required data be provided in a structured manner?

By merging and mapping existing ontologies, the University of Applied Sciences Darmstadt has access to a topic network consisting of more than 200,000 terms that thematically link lectures, final papers, professional articles and internal publications, allowing these to be evaluated.

## Keywords

Maintaining Ontologies, Semantic Web, K-infinity, Hybrid System, Merging

## 1. Introduction

The name ontology covers a new trend in the field of representing and organising knowledge, which may remind many information scientists of traditional terminological systems, as exemplified by thesauruses in particular. Ontologies are also a structured representation of a field of knowledge in the form of terms (usually concepts but also classes) and their relationship with one another (relations). Unlike in thesauruses, however, these relations can be freely defined and in principle the associative relation is removed here and the individual types of association are then made explicit, in similar way to the approaches already proposed by Schmitz-Esser (Schmitz-Esser, 1999). There is therefore a large degree of scope for the representation and managements of knowledge. In addition, instances (or individuals) can be directly incorporated into the ontology as individual examples within a class. In contrast to thesauruses, ontologies also reach a higher level of complexity as far as rules and logical conclusions is concerned (Voss, 2003). In order to fully exploit this potential, special (logic-based) ontology languages and editing programs and tools (such as ontology editors and inference machines) are being developed. The simplest scenario for reusing ontologies would therefore be to

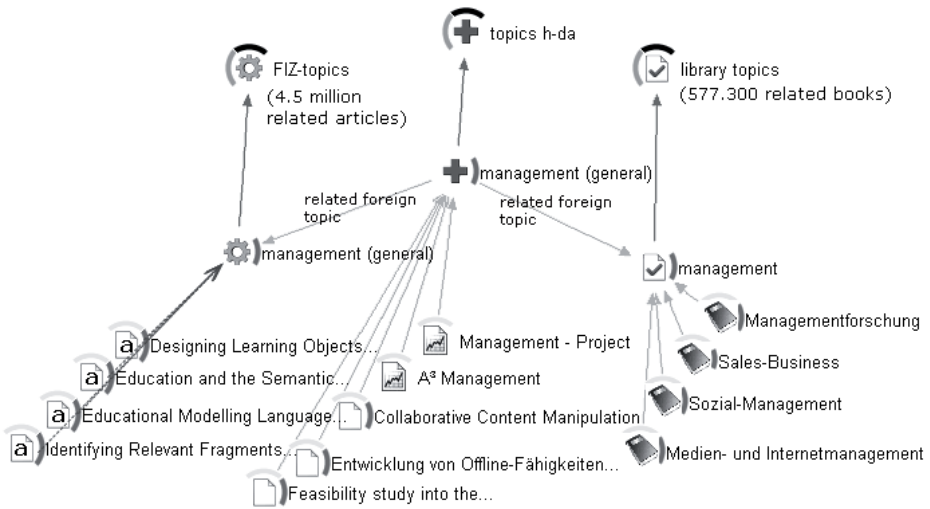
take an existing ontology as a starting point and to reprocess it to meet new requirements. This can be done by means of addition, separation or else complete restructuring. An enhancement to this scenario would be the fusing of two formerly isolated ontologies to form one ontology: merging. The product of a merging process can also serve in turn as the basis for further modifications. There are currently various methods and algorithms for merging ontologies (see e.g. (Fridman *et al.* 2000; Ehrlic *et al.* 2004), but these require intellectual supervision and decisions and can not be fully automated (El Jerroudi *et al.* 2008).

By merging and mapping existing ontologies, the University of Applied Sciences Darmstadt has access to a topic network consisting of more than 200,000 terms that thematically link lectures, final papers, professional articles and internal publications, allowing these to be evaluated (Böving *et al.* 2010).

When merging different ontologies to form one ontology as basis for a semantic database, the references to the linked content of the original ontologies should not be lost (Hitzler *et al.* 2006). This paper proposes an approach creating a new combined topic landscape which nevertheless remains linked to the original ontologies. This topic landscape will continue to grow, first as a result of updates to the original ontologies, and also as a result of new suggestions of topics for lectures, specialist articles and theses.

In addition, the entire university structure is stored in semantic objects. Employees and students are linked to their faculties and publications. The evaluation of semantic relationships between topics, publications and persons will provide the university with the opportunity to build an expert database in the future.

Precise terminological designations are essential for ontologies used by universities, where the specialist vocabulary must be of sufficiently high quality to ensure that topics are linked with professional articles, for example. Specialist terms are also continually created in this case, which only specialists are able to understand and place in their correct context. Preservation of quality and internal consistency, as well as providing a sufficient number of relationships to meet user expectations, pose the greatest challenges in the maintenance of ontologies used for scientific purposes.



### Symbols:

HDa-content: scientific articles, etc.

additional content: external articles

project documentations

books

final topics h-da (search result)

FIZ-topics

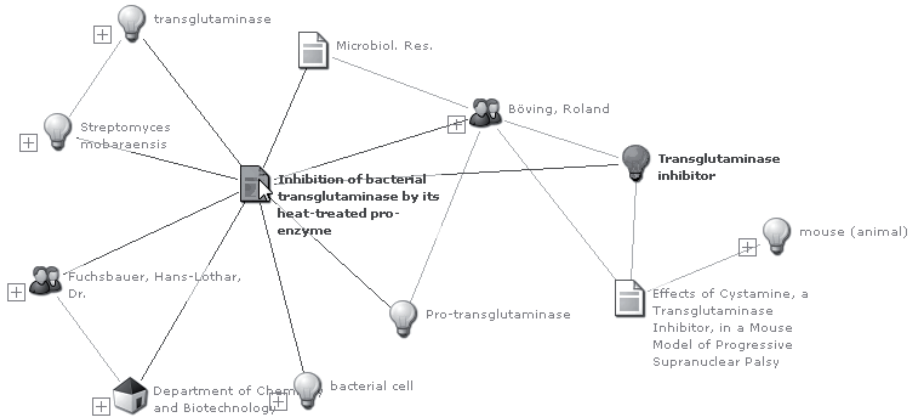
library topics

**Figure 1: The solution – besides the independently imported ontologies, the ontologies already existing will generate a new h\_da ontology (topics h-da), which will contain each knowledge object once only.**

## 2. Approach

Ontologies dedicated to technology and natural sciences are already in use in many large companies today. The benefits of providing and exchanging information, in a web-based format independent of location, by means of ontologies are indisputable. In contrast to the distinct commercial focus and product range of companies, the range of topics dealt within universities is very wide. The difficulties of building and maintaining an ontology are disproportionately greater. Different meanings and interpretations of terms and abbreviations will make automatic matching more difficult (Euzenat *et al.* 2007). In addition, in many sciences, new words will certainly evolve over time. The precise language of engineers is confronted by a world of relatively vague terms in social sciences. There are up to now no ontologies in the university sector in Germany which would be sufficiently comprehensive to link all sources of knowledge in an interdisciplinary manner, in order to provide a real solution for everyday operation. This paper will contribute to this open issue, leading to an even more complex problem that has not yet been processed, namely:

How can a complex multilingual ontology, for use in a university context, be maintained with respect to its growth, quality and consistency so that it will meet future needs?



**Figure 2: h\_da-ontology: showing relations between topics persons and content**

### 3. Future Tasks for Growing Ontologies

The maintenance and expansion of the fundamental ontology "h\_da topics", which can be seen as the heart of the system, should be given particular attention in the future. If searched topics for tagging an article are not present, or if topics are insufficiently linked with one another, then this will have an immediate effect on the acceptance of the entire system. Maintenance of the topic area is essential for the system to remain attractive for an academic context in the future, too. In order to achieve this, it is necessary to design as many automatic or semi-automatic processes as possible for maintaining and expanding the system (Falge *et al.* 2007). This includes regular topic updates of the original ontologies FIZ-Technik and h\_da library. The result of this is that h\_da topics also performs a merging and mapping update and is thus kept up to date.

In spite of the updates, to begin with many newly proposed topics for tagging articles and theses will not appear in h\_da topics, and will therefore exist initially without any further linking. The aim must therefore be to create a significant, logical semantic link between all newly proposed topics and the existing terms in h\_da topics. This will likely lead to better semantic search results, not only for new topics but overall.

#### 4. Comparison of Newly Proposed Topics with External Sources

In order to achieve this, the aim is to perform a direct comparison with an external, free and fast-growing ontology, in which it can be expected that new topics will quickly be proposed and will subsequently be discussed by an international community and internally linked. One international fast developing reference topic-map is Wikipedia, as it has been shown that not only general topics but also specialist scientific terms are represented here in sufficient depth and with detailed descriptions in the content. There will likely be good matches for technical and scientific terms here. However, it must be expected that other fields such as social sciences or economics will increasingly see newly coined words which are not connected to a nomenclature. Many of these 'soft' new topics proposed can, with the necessary background knowledge, very probably be assigned to an existing topic as a new synonym. Some of the newly coined words will in the future actually be considered to be distinct concepts. In addition to newly coined words, articles will also be tagged with abbreviations. In order to solve this problem in part, a comparison of newly proposed topics with the ontology of the Duden publishing company could be conducted. The Duden publishing company is the largest centre of competence in the German-speaking world and has an elaborately updated ontology of all German terms and synonyms. The database contains more than 500,000 topics and is designed to filter out linguistic relationships. A cooperation has already been offered by the Duden publishing company, which likewise maintains its database using the software system K-Infinity (Reichenberger 2010) and generates 260 new book releases from it annually.

The comparison of newly proposed h\_da topics with the corresponding topics in Wikipedia leads in the first instance to the following realisation: is the topic already a real term which is used, or perhaps a newly coined word? If the compared topic already exists, then the obvious thing is to examine the content recorded for it on Wikipedia for categories and linked topics and to use these for independently networking the new h\_da topics. Moreover, the majority of Wikipedia topics are stored in multiple languages. The language versions here are not translations of a main language, however, but rather are independent of one another. It may therefore be the case that a description in German contains more links than an English one and vice versa.

A multilingual approach has the advantages of achieving a greater depth of linking and also of extracting linguistic synonyms in order subsequently to complement the translations of the h\_da ontology. This would provide the universities with an ontology which exists initially in bilingual form in all scientific and technical fields and could make an important contribution to cooperation between European universities.

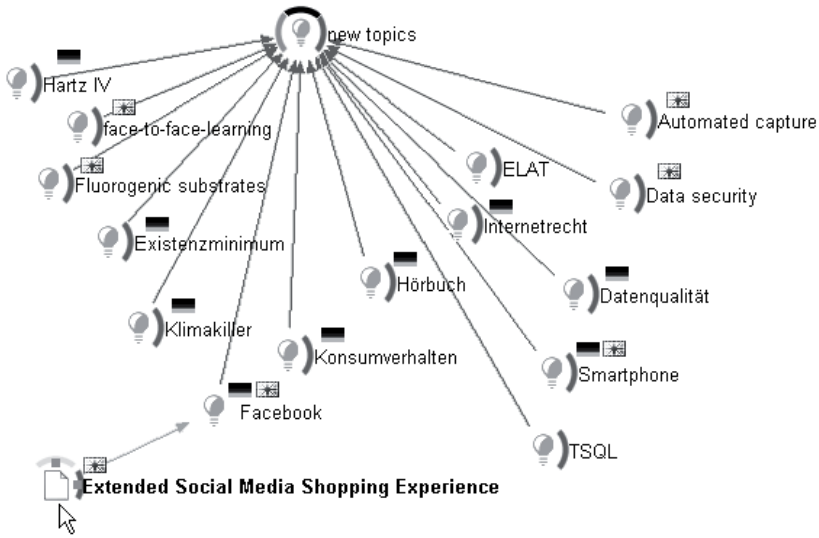
## 5. Solution:

- creation of a hybrid system for the maintenance and further development of h\_da knowledgeworld
- multilingual conceived topic network: initially German/English
- regular topic updates from checked sources
- comparison of newly proposed topics with external sources and automatic networking with recognised topics already present
- semi-automatic proposal scheme for classifying language versions and abbreviations as synonyms

## 6. Validation of Newly Proposed Topics

Uploading scientific theses and internationally published articles produces the following initial situation. Not all of the necessary keywords for tagging the documents also have equivalent topics available in h\_da topics. These keywords are set up as 'new topics' in the ontology 'h\_da knowledgeworld'. As a result, all documents can be fully tagged. Over time, a large number of newly proposed topics accumulate under the topic node 'new topics', which are not validated and are not connected to any other topics in the topic network. Each of these 'new topics' has one or more relations with available documents. Moreover, the proposed topics are already available in two different languages and in many cases also as abbreviations. Fig. 3 shows a schematic drawing of a recent extract of proposed topics. It is obvious that some topics can be classified as synonyms of topics which already exist. It is also noticeable that very new topics from the English-speaking world, such as 'smartphone', have been incorporated into the German language. In principle, only those topics are represented in h\_da topics which also have a real relationship to a book or to another publication. If there has until now been no article on Facebook, then there is also no corresponding 'facebook topic' in the network.

A comparison with corresponding search terms in Wikipedia must first evaluate the categories and links of the first section of the description and second perform this process automatically for the second language variety to be validated. Searching through further sections of the Wikipedia descriptions is less worthwhile, because too many references are generated, which cannot be put into any meaningful context without the corresponding test. The comparison of the Wikipedia equivalents not only generates important relationships with relevant terms in German and English but also provides all of the synonyms of the core term.



**Figure 3: Typical example of newly proposed topics**

If identical terms are found in Wikipedia, as in Figure 3, the 'new topics' which initially were only proposed can then be transferred with their synonyms and relations to 'h\_da topics'. Furthermore, existing topics could be expanded with the linguistic synonyms additionally found. Topics found which are ambiguous – such as 'apple' or 'android', for example, which could refer to a company or to a product – must be excluded for the time being. The fact is that not all relations represented in Wikipedia can be used. Overall, linking the topics from the first section of the description in Wikipedia will lead to a significantly better definition of the h\_da data.



**Figure 4: Results of a comparison of the newly proposed topics 'smartphone' and 'Facebook' with the first section of the description in Wikipedia**

## 7. Conclusion and Future Research

This paper addresses the following questions: How can the knowledge of a university be organised in a web-based format, interconnected and made such that it can be evaluated? In the course of writing this paper, a technical solution has been found which has already become a fundamental part of the IT infrastructure of the University of Applied Sciences Darmstadt. Another important question is: 'How can a multilingual, technological knowledge base be maintained and brought into shape for future requirements?'

What is the 'knowledge' of a university? It is the sum of all experiences and all contributions of students and staff. Knowledge ultimately exists, among other things, in the form of theses, articles, lectures and research reports. The largest knowledge pool of a university is made up, however, of the knowledge and expertise of every single member of the university. As a result of the high rate of turnover of people, knowledge and expertise are on the one hand constantly being lost, but this is replaced by a fresh intake of upcoming young students and lecturers reflecting the spirit of their time. In contrast to commercial enterprises, the knowledge of a university is very heterogeneous. The knowledge of a university is a living entity moving at speed and, on account of the many branches of study covered, also forms a part of the current total knowledge of society.

In order to model the knowledge of the University of Applied Sciences Darmstadt, a semantic ontology was constructed in which, in a first step, all organisational units and people were represented. Furthermore, all publications existing in electronic form were imported and semantic relations were established with people and departments. A networked topic area was created in parallel, which reflects the majority of all relevant topics in the departments. The creation of an h\_da specific topic area was achieved by merging and mapping existing ontologies. By semantic linking of publications and lectures with topics, the university ultimately has an experts' portal at its disposal. And the question of who has expert knowledge about topic xy can be answered by a wide range of different semantic relations.

The maintenance and the expansion of the fundamental ontology "h\_da topics", which can be seen as the heart of the system, should be given particular attention in the future. In order to achieve this, the aim is to perform a direct comparison with an external, free and fast-growing ontology, in which it can be expected that new topics will quickly be proposed and will subsequently be discussed by an international community and internally linked. One international reference topic-map which lends itself to this is Wikipedia, as it has been shown that not only general topics but also specialist scientific terms are represented here in sufficient depth and with detailed descriptions in the content. A multilingual approach has the advantages of achieving a greater depth of linking and also of extracting linguistic synonyms in order subsequently to complement the translations of the h\_da ontology. This would provide the universities with an ontology which exists initially in bilingual form in all scientific and technical fields and could make an important contribution to cooperation between European universities.



The approach is ultimately to implement a hybrid system which compares searched topics during the search process with equivalent topics from external international sources and automatically or semi-automatically transfers these topics to the university's ontology.

## 8. References

- Böving, Roland; Bleimann, Udo; Wentzel, Christoph; Walsh, Paul (2010), Semantic search scenarios to enhance University needs - based on a multilingual Next Generation Topic Map (NGTM), In: *Conference Proceedings of the 5th Plymouth e-learning conference 2010 – "Learning without limits: Facing the Challenges"*, ed. Steve Wheeler, Plymouth, 14
- Böving, Roland; Bleimann, Udo; Wentzel, Christoph; Walsh, Paul (2010), High Level Semantic Networking - Using K-infinity to Build a Multi-Ontological Learning Environment, In: *Proceedings of the Eighth International Network Conference (INC 2010)*, ed. Udo Bleimann et. al., Heidelberg, pp 361-370
- Ehric, M.; de Bruijn, J.; Manov, D.; Martin-Recuerda, F. (2004), State-of-the-Art survey on Ontology Merging and Aligning, V1 SEKT Deliverable 4.2.1, DERI Innsbruck
- El Jerroudi, Zoulfa; Ziegler, Jürgen (2008), Interactive Ontology-Mapping and Merging, *i-com* 6(3): pp44-49
- Euzenat, Jerome; Shvaiko, Pavel (2007), *Ontology Matching*; Springer, ISBN: 3540496114
- Falge, Clarissa; Cobos, Ruth; Groh, Georg (2007), Classification and Ontology Maintenance in Agent-based Knowledge Management Frameworks: A Prototypical Approach, In: *Proceeding WI-IATW '07 Proceedings of the 2007 IEEE/WIC/ACM International Conferences on Web Intelligence and Intelligent Agent Technology – Workshops*, ISBN: 0-7695-3028-1
- Fridman Noy, Natalya; Musen, Mark (2000), PROMPT: Algorithm and Tool for Automated Ontology Merging and Alignment, *National Conference on Artificial Intelligence - AAAI*, pp 450-455
- Hitzler, Pascal; Krötzsch, Markus; Ehrig, Marc; Sure, York (2006), What Is Ontology Merging? – A Category-Theoretical Perspective Using Pushouts, In: *Proceedings of the First International Workshop on Contexts and Ontologies: Theory, Practice and Applications (C&O). Workshop at the 20th National Conference on Artificial Intelligence, AAAI-05, Pittsburgh, Pennsylvania*, pp 104-107
- Reichenberger, Klaus (2010), *Kompodium semantische Netze: Konzepte, Technologie, Modellierung*, Springer, Heidelberg, ISBN: 3-642-04314-3
- Schmitz-Esser, W. (1999), Thesaurus and Beyond. An Advanced Formula for Linguistic Engineering and Information Retrieval. In: *Knowledge Organisation* 26, pp10-22.
- Voss, Jakob (2003), *Begriffssysteme - Ein Vergleich verschiedener Arten von Begriffssystemen und Entwurf des integrierenden Thema-Datenmodells*, eprints.rclis.org



# Lessons Learned from a Control Group Experiment on Virtual Team Performance

Ralf Friedrich<sup>1,2</sup>, Udo Bleimann<sup>1</sup>, Ingo Stengel<sup>1</sup>, Paul Walsh<sup>2</sup>

<sup>1</sup>Centre for Advanced Learning, Media and Simulation, University of Applied Sciences Darmstadt, <sup>2</sup>Cork Institute of Technology, Computing Department  
ralf.friedrich@h-da.de, u.bleimann@fbi.h-da.de,  
ingo.stengel@h-da.de, paul.walsh@cit.ie

## Abstract

Current research on virtual teamwork tends to focus on the intercultural aspects (Casey, 2010), whereas the research presented in this study focuses on the social roles and processes of virtual teams. Here we investigate how can basic democratic processes lead to a better performance of virtual teams. To answer this research question, a global control group experiment was done and many lessons learned from the experiment are described. There are two main categories of lessons learned. The first set is about the management of a global control group experiment and the second category is about the tools and processes of virtual teamwork.

## Keywords

Virtual Team Research, Elective Leadership, Control Group Experiment, Lessons Learned, Management of a Control Group Experiment, Virtual Team Processes

## 1. Background

This research investigates, if the performance of a virtual software development team can be estimated. To answer the research question, a control group experiment was designed and carried-out for the first time in 2010. In total 145 participants globally signed-up for the experiment, of which 68 participants completed the experiment. This drop-out of participants is a little bit higher than the average (Kanwattanachi, and Yoo, 2005).

This paper describes the lessons learned in the management of the experiment and the changes for its next round, which are due to start early 2011.

## 2. Objectives of this Research

Originally, this research wanted to investigate, if virtual teams can be as successful as traditional face-to-face teams. However, before this question can be answered, a profound understanding of what is going on in virtual teams is required. The goals of this research are:

1. To identify key elements influencing the performance of virtual software development teams and

2. To define parameters which will allow to estimate the most likely performance of the virtual team.

To find answers, this research applies the control group experiment research method with volunteers around the globe (Friedrich, 2009). Other research in the area of virtual teams is based on student teams from different universities (Pears and Daniels, 2010) or within one large international company. Then the related research is based on questionnaires or on observation of virtual teams. This research observes truly virtual teams over a time period of 12 weeks. Due to this setting it is expected to identify new insights through observation.

### 3. Setting of the Experiment

The volunteers have the task to create a web-portal using the V-model of software engineering. During the experiment the timely delivery of the software engineering documents and their quality is assessed. The teams were evaluated on the timely delivery of the documents, the quality of the documents and the completeness of the web-portal compared to the blueprint provided in the scope statement of the experiment. All project deliverables are assessed by two external raters.

The objective of the experiment was to identify the impact of the virtual team processes listed below on the performance of the team:

1. Get-to-know-each process
2. Leadership process and
3. Feedback processes (Geister et al, 2006)

The hypothesis was that these processes impact the performance of the virtual team. If they are managed in structured approach, the performance of the team should increase.

This research is based on observation of actual virtual team performance in a control group experiment setting. All participants are randomly put into teams of five participants. Half of the participants received a treatment, called "Elective Leadership". The elective leadership approach is a continuation of the shared leadership described by Müthel and Högl, (2008). The other half works as they would usually work.

In addition it was planned measuring the motivation of the different teams through an approach called Motivatoring (Martens, 2008). Motivatoring measures the the motivation of a team member and compares the members motivation with the team motivation in the areas of autonomy, competence and social relatedness.

This additional measurement was planned to identify differences in the motivation

between the elective leadership teams and the other teams.

During the experiment, the participants received trainings through a learning management system or through webinars. Throughout the experiment, the participants had a hotline which was heavily used.

During the experiment several free tools for virtual teams were recommended:

1. Dropbox ([www.dropbox.com](http://www.dropbox.com)) for file management. This tool is very useful to synchronise the project documentation on all computers of the participants, as it allowed all team members had access to the same information.

2. SecondLife ([www.secondlife.com](http://www.secondlife.com)) for social communications, skype ([www.skype.com](http://www.skype.com)) for chat and video conferencing, VSee ([www.vsee.com](http://www.vsee.com)) for screensharing and video-conferencing, SlideShare ([www.slideshare.com](http://www.slideshare.com)) and Powwownow ([www.powwownow.com](http://www.powwownow.com)) for showing prepared presentations online.

3. MindMeister and Googlewave for collaborative virtual teamwork on documents and ideas.

The tools have been identified during a semester project with media students of the University of Applied Sciences of Darmstadt in the winter semester 2009/2010.

The experiment started on 10<sup>th</sup> of March 2010 and ended on 30<sup>th</sup> of June 2010.

## **4. Lessons Learned**

There are plenty of lessons learned from this experiment. The lessons learned are grouped into lessons learned for virtual teamwork and on the management of the experiment.

Even though, the experiment was tested with media students before its first round, many things went off in a completely other direction as planned. Here are the main findings on the management of the experiment:

### **4.1. Lessons Learned about the Management of the Experiment**

1. Good marketing through social media and PMI® Chapters One of the main challenges of this research approach is finding enough volunteers willing to spend 60 hours of their leisure time for the experiment. Within a six weeks period 145 participants from all continents signed up for the experiment. The experiment was marketed through the social media networks of XING and LinkedIn. Both networks attracted many people. The PMI® EMEA newsletter and the PMI® Frankfurt Chapter Newsletter are read by many project managers around the world. So the response was really good and will be repeated for the next round. It proofed the power social media in today's digital world (Hilker, 2010).

1. Trouble with PMI® (Project Management Institute) for the PDU's (Professional Development Unit) One key element of the recruitment campaign was to provide 60 PDU's for PMP (Project Management Professional) qualified project managers. 60 is the number needed for one re-certification cycle of three years. In principal this should have been possible and it was coordinated through the PMI Frankfurt Chapter. However, PMI HQ in Pennsylvania took another view and only granted up to 25 PDU's. Also they involved their lawyer making sure that there is a clear communication about their expectations and intentions.

This issue came up after all volunteers had been recruited. So there were several communications sent to the participants clarifying the issue. As a result, three volunteers stepped down. Many of the other participants gave us encouraging words and continued with the experiment. The lesson learned is that the motivation of the people to participate in such an experiment is different than expected. Based on this experience there will be a different value proposition to the participants next time.

1. High dropout of participants during the experiment Despite the fact that many volunteers signed up for the experiment, also many dropped out (Kanwattanachi, and Yoo, 2005). This is a fundamental problem when working with volunteers. It was very easy to say yes, I will participate and then do not show up for team meetings or missing deadlines. Some teams had to be restructured over and over again. To avoid such a high percentage of dropouts, the next time there will be a commitment fee of €99,-. In return they will get a two year free membership in the newly founded VIPMC - Virtual International Project Manager Club with plenty of member benefits. There is currently a media master student researching the differences between a social media network and an internet club so that the VIPMC gets a real sharp profile.

2. The elective leadership treatment was not enforced Half of the participants were in so-called elective leadership teams. These teams received some special training, elected a leader, produced a leadership charter for their team and were asked to implement three virtual team processes:

- a. The get-to-know each other process where personal information is exchanged in a structured format in the beginning of the experiment.
- b. A two-way leader-team-feedback process. This process allowed the team to give the elected leader on a regular basis some feedback. Also the leader had the option giving the team some feedback.
- c. The team decision-making process, leading to transparent decisions facilitated by the elected leader.

Also the team had the option to re-elect a leader, if the leader did not perform as expected, however, none of the teams made use of this option during this study. A possible explanation is that team members are more willing following a leader they have elected and believe in. They want to proof to themselves that they have made the right choice. It seems that the elective leadership treatment is a possible route to

explore further, because of 12 elective leadership teams, 6 completed the experiment compared to the 13 normal teams only 4 non elective leadership teams which completed the experiment.

For the next round of the experiment, the elective leadership treatment will be enforced with an application recording the process steps of elective leadership.

1. Motivator tool was missing Motivator is a validated measurement approach for team motivation (Boekaerts et al, 2010). Part of the experiment design was feedback measurements of all teams using the Motivator tool on Moodle. These measurements were supposed to compare the level of motivation between the elective leadership teams and the normal teams. Unfortunately, it was impossible to get the Motivator tool installed on time for the experiment. As a result, the motivational measurements were too rough and will be discarded. For the next round of the experiment, the Motivator tool will be installed on Moodle before the experiment starts.

2. Missing rituals Participants expected more rituals throughout the experiment. This is inline with the research from Koster (2002). Rituals seem to be important for the virtual team members to give orientation and safety. The main feedback was that the experiment started without a formal kickoff meeting. The participants knew the start date and the team fellows and just waited. For the next round of the experiment, participants will get a more detailed structure of communication routines from the beginning to the end of the experiment to fulfil this need.

3. Some information about the experiment was delivered too late The idea of the experiment was that all information is available on Moodle and the teams would use Moodle as a self-service for project information. However, participants did not read all the material on Moodle. This resulted in some frustrations and dropouts. In particular the information about the scope of the project was unclear for the first couple of weeks (Duarte and Synder, 2001). This resulted in a slow start of the planning activities (Edwards & Sridhar, 2002). This issue was mitigated by delivering scoping webinars. For the next round of the experiment there will be a boot camp for the teams. The boot camp will consist of a couple of webinars so that the participants understand the working environment and the project in detail.

4. Missing technical competencies in some teams Some teams did not have a participant who was able to install the web-server and the SQL-database to finish the project. As the teams were fully selected on a random basis, this aspect was overlooked. The assumption was that only software professionals would participate in the experiment. For the next round of the experiment, it will be ensured that each team has access to a software engineer. Either the software engineers will be grouped in a pool and can be leased by the teams or each team will have a software engineer on it.

5. Database not in place to capture the progress of the teams in real time As this was the first large scale iteration of the experiment and 25 teams started in the beginning, a huge amount of data has been generated. Now the challenge is to build the database

from all the archives. This results in a delay in the analysis of the experiment. Also some data is missing. For the next round of the experiment, all teams will submit a weekly status report and the current performance can be mirrored back to all participants. This will add an aspect of competition which is hopefully beneficial.

6. Closing sessions without any tangible results As the kickoff sessions were missed, closing sessions were organised. Nearly all of the remaining participants showed up for the sessions. The sessions were organised in SecondLife and as webinars. At the sessions, the portals of the different teams were shown. However the participants expected an analysis of the results of the experiment which could not have been provided due to the missing database. For the next time of the experiment, the scoring list of teams and the insights from the experiment will be presented at the closing sessions.

7. The participants ignored the existence of a project repository in Moodle In the design of the experiment, Moodle was a central element in the data management. However the participants ignored the existence of Moodle and implemented their own systems. As a result, the management of the experiment lost track of what is going on in the teams. After having interviewed the participants, it became evident that the majority of them never worked with a learning management system before. For the next time of the experiment, participants will receive a sound introduction into the Moodle environment.

8. Evaluators were recruited after the experiment First the experiment was performed and then the evaluators came on board for the analysis of the results. This was significantly too late, because missing data distorted the results. Next time, the evaluators have to rate just-in-time making sure that all data is available.

9. Good personal experience for the participants who continued until the end The feedback from the participants who continued until the end stated that it was worth spending the time on it. Some participants worked for the very first time in a virtual team and they found this experience valuable for their professional career.

#### **4.2. Lessons Learned on Virtual Teamwork and Performance**

Several lessons learned can be applied to the usage of tools and internet-availability during virtual teamwork itself:

1. SecondLife is in its current form of limited use for virtual teams The main reasons are that the application is too complicated to use for the average user (Ojstersek and Kerres, 2008). One participant sent us an e-mail: *“I configured my avatar and lost my head. What should I do now?”* or another participant wrote: *“I could not talk to the other team members. However I impressed them with my new outfit.”*

Based on the observations of the teams, for good virtual communication are outside the features of SecondLife. Team members require:



- To be able to work in parallel on the same document
- To see the computer screens of the other team members and
- To be notified about changes in documents.

All these features are excluded from SecondLife.

The main benefit of SecondLife was in the recruitment of participants. This part of the marketing campaign got a lot of attention. Also, some teams managed to use SecondLife for their team meetings and the voice communication. However, the impact of SecondLife on the result of the deliverables cannot be traced back. For the next round of the experiment, SecondLife will be used again and the participants will get links to open source collaborative tools on the internet (Thissen et al, 2007). Also the company VEA ([www.ve-a.com](http://www.ve-a.com)) will grant access to their virtual team collaboration tool for the participants of the experiment. This tool will allow managing the documentation, the meetings and the deadlines in an innovative approach. The tool has been selected, because VEA is offering the tool for free and it meets the requirements of the participants. A professional virtual team tool is needed to overcome any frustrations of the participants in conducting virtual meetings (Donker and Blumberg, 2008). Participants who encounter problems in the beginning of the experiment tend to abandon the experiment early. The frustration level in virtual teams is low.

1. Free virtual collaborative team tools have a limited performance After the disadvantages of SecondLife became evident, the need for alternative collaborative team tools became obvious. The following observations made are worth sharing:

a. VSee ([www.vsee.com](http://www.vsee.com)). This tool allows for team video conferences and screen sharing. It had good performance in its free version for video conferences and screen sharing with up to three participants. If more than three participants joined a video conference, then the tool slowed down significantly.

b. It is notable that the two teams which have been finished first have both used Dropbox. This aspect of virtual teamwork will be investigated further during the next round of the experiment, as it seems that the professional management of documents may be a key success factor for virtual teams (Damrau, 2006)

To overcome all the tool issues for the next round of the experiment, participants will receive an introduction of these tools in the beginning of the experiment. Additionally, the company VEA granted free access to their virtual team collaboration tool.

1. Technical access problems in some areas of the world Even if the internet is used globally, it behaves differently in some areas of the world (Vinaja, 2002). In particular we encountered problems with the participants from Iran. Some of the virtual team tools and SecondLife were blocked due to the international embargo and sometimes the whole internet was being shut down in the country. Another area where

problems happened was Polynesia. The participant there had only internet through satellite communications and encountered severe problems getting a stable internet connection. Team members who encountered technical problems were dropping out faster than team members with a good reliable technology base. So the reliability of the technical environment seems to be a key to success for virtual teamwork.

## **5. Value of the Experiment for the Research**

The experiment can be considered a failure in terms of rigorous criteria. However, initial results point at several promising routes to be further investigated in the second round of the experiment. In particular the planning of the experiment and the training of the participants will be managed differently.

On the planning side the database will be in place. Also Moodle will be updated and all the feedback, including the Motivatoring, and reporting structures will be ready. Also the webspace will be available for the teams. There will be a tool on Moodle on how to enforce the elective leadership treatment. These activities should result in a full data capture of the experiment and fast turnaround times towards the participants.

All participants will receive a “boot camp” on how to use Moodle, the different virtual team tools and what is required in terms of weekly reporting and a detailed presentation of the scope of the project. The result of the training will be a good orientation of the participants in the environments of the experiments. There will be a formal kickoff session and followed by the boot camp and formal bi-weekly status reports. Also the feedback processes to the participants in terms of where they stand in comparison to the other project teams will hopefully result in excellent research data, low dropouts and a valid experiments.

Without the experience of going through this iteration of the experiment, many of the lessons learned could not have been identified. Now the experiment reached a mature state which will allow for sound experimental research.

## **6. Conclusions**

Running a global control group experiment with volunteers is a true challenge. The first pre-requisite for a successful execution of the experiment is a sound planning approach. Even with a validation on a local level, where participants can have face-to-face interactions, the full virtual environment reveals different challenges in terms of communication and motivation. These factors need to be addressed in the planning stage.

Managing a large group of volunteers requires a full-time support. It cannot be assumed that volunteers have an understanding of virtual teamwork when they join the experiment. Also, they need quick answers to their questions to keep being motivated.

If information is missing in the design of the experiment, it is very difficult to produce them during the execution of the experiment.

All communication processes need to be trained. In particular the tools being used during the experiment have to be understood by the participants.

The key conclusion is that the treatment of elective leadership is a potentially promising approach to find the information required to find insights into virtual team management. Making face-to-face team processes explicit in virtual teams looks like a key success factor for virtual teamwork. Also empowering the teams to elect their leaders seems to be the right thing to do to gain the necessary commitment from the team members. These findings will be evaluated further during the next round of the experiment. The results may reveal real new insights into what is going on in virtual teams.

One change is viewed as critical for the success of the experiment: the introduction of a commitment fee. This fee will most likely result in a lower number of volunteers participating and the marketing has to propose a different value proposition so that enough volunteers register for the experiment. If the marketing of the new value proposition fails, then too few participants will be recruited. On the other hand, it is expected that they will enjoy the experiment more and will be higher motivated, leading to a significant lower drop out rate and a valid academic experiment.

## 7. References

- Boekaerts, Minnaert, Martens, T. and Brabander, (2010), „Can QWIGI help?“, Towards an Understanding of Motivational Coregulation in Learning Groups, Porto, 2.-4. 9. 2010
- Casey, V., (2010), „Imparting the importance of culture to global software development“, 2010 September • Vol. 1 • No. 3 acm Inroads
- Damrau, J., (2006), „Managing a Virtual Team“, EServer TC Library, URL: <http://tc.eserver.org/27871.html>, Last accessed: 3<sup>rd</sup> January 2011
- Donker, H. and Blumberg, M., „Collaborative Process Management and Virtual Teams“, CHASE'08, May 13, 2008, Leipzig, Germany. Copyright 2008 ACM 978-1-60558-039-5/08/05
- Duarte, D. L. and Synder, N. T. (2006), „Mastering Virtual Teams: Strategies, Tools, and Techniques That Succeed“, 3. Edition, John Wiley & Sons, ISBN: 0-7879-5589-2
- Edward, K.E. and Sridhar, V. (2003), Analysis of the Effectiveness of Global Virtual Teams in Software Engineering Projects
- Friedrich, R. (2009), „The application of e-learning during control group experiments within virtual project team research“, SEIN09, Darmstadt
- Geister, S., Hertel, G. and Konradt, U., (2006), „Effects of Process Feedback on Motivation, Satisfaction, and Performance in Virtual Teams“, Small Group Research Volume 37 Number 5 October 2006 459-489, Sage Publications, 10.1177/1046496406292337
- Hilker, C., (2010) Social Media für Unternehmer: „Wie man Xing, Twitter, Youtube und Co. erfolgreich im Business einsetzt“ 1. Aufl., Linde, Wien, ISBN: 978-3-7093-0322-1

- Kanwattanachi, P. and Yoo, Y. (2005) „Dynamic Nature of Trust in Virtual Teams“, Sprouts: Working Papers on Information Environments, Systems and Organizations, ISSN 1535-6078
- Kostner, J., (2002) „König Artus und die virtuelle Tafelrunde. Wie Sie Teams aus der Ferne zu Höchstleistungen führen“, N.-A., Signum, ISBN: 385436248X
- Martens, T., (2008), „Unterstützung der intrinsischen Motivation beim Lernen von Methodenlehre in Gruppen mit Hilfe von Online-Monitoring“, 7. Fachtagung für Psychologiedidaktik und Evaluation, 2. - 3. Mai 2008, Frankfurt am Main
- Müthel, M. and Högl, M., (2008), „Tackling the Leadership Challenge in Dispersed Project Teams“, project management aktuell, 5/2008
- Ojstersek, N. and Kerres, M. (2008), „Lernen in Second Life betreuen.“ In Grundlagen der Weiterbildung. Praxishilfen. Neuwied: Wolters Kluwer
- Pears, A. and Daniels, M. (2010), Developing global teamwork skills: The Runstone project“, Education Engineering (EDUCON), pages 1051 - 1056, 10.1109/EDUCON.2010.5492460
- Thissen, M. R., Page, J. M., Bharathi, M. C., Austin, T. L., „Communication Tools for Distributed Software Development Teams“, SIGMIS-CPR'07, April 19–21, 2007, St. Louis, Missouri, USA, Copyright 2007 ACM 978-1-59593-641-7/07/0004
- Tyran, L.K., Tyran, C.K. and Shepherd, M. (2003) „Exploring Emerging Leadership in Virtual Teams“, Virtual Team that work, ISBN 0-7879-6162-0, John Wiley & Sons, Inc. Pages 183 - 195
- Vinaja, R., (2003) “Major Challenges in Multi-Cultural Virtual Teams.” Conference Paper in Proceedings / American Institute for Decision Sciences, Southwest Region (2003), pages 341 - 346. DOI 103-397-179

# **A Discourse on the Need for an Ethical Theory Suitable for Application within the new Societies of the Digital Age**

James O'Sullivan

Department of Computing, Cork Institute of Technology, Rossa Avenue,  
Bishopstown, Cork, Republic of Ireland  
e-mail: josullivan.c@gmail.com

## **Abstract**

Since the turn of the century and the dawn of the digital age, online communities have witnessed significant growth in their importance. Significant numbers of virtual environments now exist, within which millions of individuals interact socially and economically, engaged fully in what is equivalent to a physical encounter, the only differences being the virtual representations through which they interact, and the physical security that this representation affords them. Though physically absent, individuals are fully engaged psychologically, and thus open to the same ethical dilemmas presented through reality. Application of real-world moral codes is encumbered by the existence of what I call “the role-play argument”, an ethical excuse which lends itself to increased complexity in questions of moral philosophy. In this paper, having outlined the role-play argument, I take the most practical branch of ethics, and apply its primary principles to an incident that occurred within one of the earliest incarnations of an online community. Through this I examine the effects of the role-play argument on the validity of such an application.

## **Keywords**

Normative Ethics, Virtual Environments, Role-play Argument

## **1. The New Societies of the Digital Age**

Many argue that societies require some form of ethical framework if they are to function as right thinking individuals would expect them to. Our need for social order is satisfied by our observance of how we should behave as a society, this being influenced by what we perceive as being right and wrong. The legal systems upon which we rely so heavily take their direction from this basic distinction. Human nature alone cannot be trusted to provide social order; without the constraints imposed by such frameworks, which I would suggest are dictated by the philosophies and codes upon which our understanding of morality is often based, man would destroy itself (Arendt, 1972). Such theorising has remained relevant since the dawn of what we know as civilisation. As a species, we require coexistence, and to achieve this we are dependent on social structures that are largely informed by a society's moral values. Most commentators would generally agree that groups of people living together in an ordered community constitutes a society. The emergence of virtual

societies has given rise to a whole new realm of social interaction, and with it, a range of ethical considerations that warrant deliberation. It is imperative that the concept of a virtual society be both established and defended from the outset, as the entire merit of this examination is based on the acceptance of this concept. Let us first look at what constitutes a virtual society, providing both a definition and a clear understanding. I would suggest the following: virtual societies are computer generated environments in which large scale communities have been built and evolved, facilitating social interaction between real individuals across a network infrastructure. There are numerous terms that might be applied to such a construct: virtual environment, virtual world, virtual realm, online community, even online game. They all, essentially, portray the same thing, that being an online community where people interact. In order to develop a clear understanding of a virtual world, all one has to do is consider the activity associated with such an environment at its most basic level. Firstly, two separate individuals both create an avatar. Having done so, through the Internet, these individuals interact, represented by their avatars, within a digital environment that is hosted on a remote server, making it consistent across all of its inhabitants. Examples include *Second Life*, *Habbo Hotel* and *Free Realms*. In addition to these online communities, there exists a multitude of online games that are essentially the exact same construct, only with a focus on more challenge orientated and competitive user interaction.

The first response in respect to the legitimacy of these virtual environments as recognised societies is often dismissal, backed by arguments that online communities are in themselves little more than a pastime offering a distraction in the same way as any other form of entertainment. It is true to say that their existence is facilitated in a fashion similar to that of many other forms of entertainment software, but these are merely the conduits. A society is not determined by the structure upon which it is built, but rather by the inhabitants and interaction that it supports. Inhabitants of a real-world community are just as dependent on a range of manual and electronic modes of communication for their interaction. The fact that online communities are dependent on particular implementations of networking technologies is of little consequence.

Let's consider the concept of a virtual society, and whether or not it is in fact legitimate, from a more fundamental perspective. There are two constituents to be considered: the environment and its inhabitants. Who are the inhabitants of a virtual world? People. The artificial characters that populate these communities alongside the human occupants are little more than a mechanism through which the developers can ensure the fulfilment of vital roles, either structurally or, in online games, in terms of plot progression. The true interaction within these realms is between members of our species. But what is man? Attempts to define our species are many: philosophical, theological or physiological in origin. These need not detain us, as my purpose here is to simply demonstrate that it is indeed humanity that populates virtual worlds. Whether you interact with an individual physically, or through their virtual representation, is of little consequence. Linden Lab's online game, *Second Life*, boasts somewhere in the region of 18 million registered accounts, with publicly available statistics from the developer showing increasingly high volumes of players logging in concurrently, and in turn interacting with each other and the environment

in which they reside both socially and economically. Is this not a legitimate society, millions of conscious individuals interacting within a community that has its very own set of customs and organisations? I contend that this is a society, in every sense.

Why conduct an ethical examination within this arena? One could argue that while virtual environments may have a legitimate claim to the title of society, the morality of those who exist within such spaces is not a cause for concern – after all, “it's just a game”. This is certainly not the case. It is beyond the remit of this paper to discuss in depth the psychology of the relationships that individuals form with their virtual persona, but it is necessary to give some recognition to the gravity of such relationships. Avatars are often expressive of a user's personality, which facilitates attachment between the two. Wolfendale argues that avatar attachments meet the criteria of more traditional forms of attachment, and thus can carry the same psychological significance (Wolfendale, 2006). Schroeder's *The Social Life of Avatars* examines this deep rooted psychological connection in even greater detail, going on to claim that “some users have even come to identify their avatar as “more them” than their corporeal body” (Schroeder, 2002). If the morality of this arena is to be disregarded, then individuals could suffer psychological and emotional damage while existing within the virtual space – damage that will be felt in reality. Avatars are not real, the individuals behind them are. It is because of this that moral codes are just as relevant in the virtual space as they are in reality.

## 2. The Role-play Argument

Virtual worlds are largely founded upon the concept of role-play, and the ability of their inhabitants to engage in such escapism. The communities that exist within these virtual societies rely on role-play as a means of making their societies more authentic replications of reality. In essence, people must be allowed to role-play and engage with both their avatars and the environment with which they are surrounded, in any way that they choose. The role-playing phenomenon did not start with the emergence of virtual worlds: this merely facilitated a heightening in its engagement. People have been participating in role-play across a range of socio-cultural activities for centuries. Acting is effectively role-play. The youth of the 70s and 80s would have practised role-playing in popular boardgames, such as *Dungeons and Dragons*. The virtual avatar is only role-play in its current form, but global in nature. To some, role-play is an art, a form of improvisation. To others, it borders on obsession, providing a means of escapism that may or may not be considered healthy. As far as indulgence in their virtual persona is concerned, role-players vary in degree. Some will treat such activity as an enjoyable form of interaction, taking part intermittently when the occasion permits. Others will take it far more seriously, refusing to break character throughout the entire course of their online interaction. The latter is not uncommon.

What I refer to as “the role-play argument” is, essentially, an argument that exists within the virtual space, and provides users of online communities with a means of justifying any action that might be deemed morally questionable. It is centred around the concept of role-play, a popular practice where users assume the role of a fictional character when interacting within such environments. Their actions would be

dictated by that character's fictional personality and traits, rather than their own. Take, for example, the *Eve Online* “Intergalactic Bank Scam” that occurred back in 2006. The incident involved fraudulent activity that resulted in a high volume of players losing out on the equivalent of some \$100,000 of in-game currency. While some users were outraged by the heist, others lauded it as the definitive example of the elevated form of engagement that interactive online communities can provide, and pointed to it as an example as to why virtual environments are now so heavily populated. Here we can focus in on the core of the role-play argument. It is perhaps a way through which users can justify their actions in the name of the role-play experience. Essentially, if someone role-plays as a racist, they may not be a racist, simply a good role-player, the same as any actor who plays a particular character. This is a justification that some will use when interacting under the guise of their virtual persona. The danger lies in the fact that a user's personal ethics will not necessarily be reflected through the actions of their avatars, with individuals possibly tempted to indulge in otherwise prohibited activity as a means of further heightening the sensation of their escapism. This is more than just a case of explicitly outlining what is and is not permitted within the virtual space, as if constraints are placed on virtual societies that do not allow role-players to engage with their surrounding community as freely as they would be allowed to do in reality, those societies would lose the very purpose of their existence and undoubtedly flounder.

Consider the infamous *LambdaMOO* virtual rape case. The term “virtual rape” is somewhat ambiguous, and so requires clarification. It has been used to describe the act of forced sexual explicitness in a virtual environment. It has a variety of manifestations, and is largely achieved through the use of various forms of malicious computer programs. The most widely known example of such an incident occurred in the early 90s, when Mr.\_Bungle, a user of the *LambdaMOO* virtual community, made use of a program called Voodoo Doll to attribute such sexually explicit actions to the virtual representations of other players. Victims of the attack afterwards claimed that the incident was a breach of their civil rights (Dibbell, 1999). Justification through use of the role-play argument is truly unique to the virtual arena – nowhere else would it be possible for an individual to even consider the justification of Mr.\_Bungle's actions. But, considered in the virtual space, the user responsible could respond that the character of Mr.\_Bungle was a rapist, so he played the role of a rapist. Doing so, he could argue, is the very same as the user whose Elf speaks in Elvish, or whose Dwarf speaks in Dwarvish. It is the same as the individual who plays the villain upon the stage or the author who portrays such an incident in their story. Mr.\_Bungle's user was simply playing the role of a character in a community dependent on players doing as much, regardless of how despicable the manifestations of that role-playing might be. So we reach the primary concern of this examination: what ethical theory can be used to successfully combat the force of the role-play argument?

### 3. Normative Ethics

As a branch of philosophical ethics, normative ethics is fundamentally concerned with moral hypotheses by which our conduct can be regulated. It seeks to propose answers to questions of right and wrong through the exploration of moral standards.



While meta-ethics can be viewed as the study of ethical codes from a more conceptual perspective, seeking understanding to their meaning and derivation, normative ethics is more empiric in its approach. There are three categories of normative theory: virtue ethics, deontology and consequentialism. Virtue ethics places an emphasis on one's moral character, in contrast to the deontological approach, where duty and rules assume prominence, and consequentialism, which is focused on the consequences of one's actions. The practical nature of the normative approach to ethics is what makes it useful here, where a practical solution is required to a tangible problem. As virtual environments and their populations increase in number, so too will the ethical issues which they present. Therefore, it is useful to investigate which moral codes can be practically applied within this arena.

### 3.1. Virtue Theory

Aristotle was the first advocate of virtue ethics, which was later expanded upon by Plato. Virtue ethics differs from the more precisely defined codes of conduct suggested by other schools of moral thought, emphasising instead the need for the development of a more habitual good, essentially that individuals should cultivate moral characteristics within themselves. Having developed these characteristics, one will then act morally, regardless of any rules, codes or social expectation: "A virtue is a trait of character that is to be admired: one rendering its possessor better, either morally, or intellectually, or in the conduct of specific affairs" (Blackburn, 2008). Virtue theory differs from deontological and consequentialist approaches in the sense that it looks to ask what traits make an individual good, rather than what is the right thing to do in a particular situation (Rachels, 2002). Aristotle and Plato examined such virtues as wisdom, sincerity, generosity and truthfulness.

I would suggest that the problem with virtue theory is that it is too reliant on the moral development of the individual. The development of good characteristics within a person is dependent on far too many social variables. In addition, the definition of a good virtue is not necessarily applicable to all individuals in equal measure, and the virtues themselves are often open to contention. Take honesty, for example. I would argue that complete honesty is not a good trait for someone to develop, considering that there are times when the telling of untruths can be justified as a necessary evil. Take another virtue, tolerance, and apply the same reasoning. To what extent should tolerance be applied? Should a good man tolerate his racist neighbour? If not, is he, by the logic of virtue ethics, no longer a good man? All of the virtues are open to conflicts of interpretation in this way.

However, there is merit in the application of such ideology to virtual environments, for reasons highlighted by Elizabeth Anscombe's 1958 article, *Modern Moral Philosophy*, to which many commentators attribute the revival of the thesis. In her piece, Anscombe makes the point that the ethical codes that have been put forward by modern moral philosophy cannot function independently of a practical body of enforcement (Anscombe, 1958). When considered in the context of virtual environment's and their inherent lack of regulation, virtue theory offers the advantage of being based on little more than the development of "good" qualities by the inhabitants of the virtual world. However, while it might be pleasant to think that

the ethical dilemmas in the virtual space can be resolved through the development of such characteristics as benevolence in its inhabitants, such a notion isn't very practical. The virtues possessed by a user may not be reflected in their digital representation, for reasons outlined in the role-play argument. In addition, theorists are at odds over which virtues should be considered most important. In addition, most virtues are in themselves very ambiguous in their definition. Virtue theory addresses the question of moral character, whereas other theories focus on decision (Johnson, 2003). In such cases as the *LambdaMOO* incident, it is decision that is required.

When one considers the role-play argument, it is hard to see how virtue ethics can be applied within this particular arena. It is true to say that you are interacting with the individual behind the avatar, rather than the avatar itself, which is little more than a vessel, but again the question is raised as to whether a person's moral character will be wholly reflected in their virtual persona, or rather, will it be the character that they are role-playing as. In summary, in the absence of further hypotheses in the field of virtue ethics, and association between an individual's moral characteristics and those reflected by themselves online, this school of thought is simply too vague for effective application.

### 3.2. Deontological Ethics

If not virtue theory, then what branch of normative ethics can be turned to? Deontologists maintain that the moral dilemma is in the act, rather than the consequences of that act. For example, in the case of a murder, the ethical focus would be on the lack of moral reasoning that surrounded the actual killing, rather than the death itself. The deontological approach to ethics maintains that some choices are explicitly forbidden on a moral basis, regardless of the consequence. The origins of deontological theory can be traced back to Kantian ethics. In his summation of moral dilemma, Kant differentiated between inclination and duty. Our natural urges, he proposed, are the influences by which we act out of inclination, while decisions based on rationale lead an individual to act out of duty: "Worth of character is shown only when someone does good not from inclination, but from duty: when, for instance, a man who has lost all taste for life and longs for death still does his best to preserve his own life in accordance with moral law" (Kenny, 2000). The critical distinction in the theory is whether or not an individual acts ethically out of duty: that morality exists only when an act is based on ethical foundations rather than self-interest, when intention is placed above consequence. If a person performs an action because they know that that action is ethical, then as a result they have acted morally according to this theory. They would not have acted ethically had they performed the same action, but for motives other than the fact that they had a moral duty to do so. Returning to the example of murder: if a person doesn't kill their enemy because they don't want to be caught, they have not acted morally. This is because, while they have chosen what would be looked upon as the right thing to do, they have based their choice on the fact that they would be caught, not because they truly believe that killing is wrong. If a person doesn't kill their enemy because they know that the act of killing is wrong, then they have acted morally, even though the consequences of both rationales are precisely the same.

Applying the deontological theory to the *LambdaMOO* incident requires a separation of the act from the result of that act. In this instance, the act was the forced attribution of sexually explicit gestures to the virtual representations of other players, by Mr.\_Bungle. If one considered the intention, as is, in a real-world situation, there would be no question that the deontological approach would deem the act as immoral. However, in the virtual space, if someone invokes the role-play argument, can deontological ethics still conclude that the act was immoral? It could be argued that Mr.\_Bungle was acting out of a duty to his character's sadistic personality, that he was simply behaving as any true role-player would. The consequence of this intention, the effects that his act might have had on the other players, does not render his actions immoral if his motives were genuinely based on providing a realistic role-play experience. One interpretation of deontological ideology would be that one should not do something that is considered wrong, even if it is to achieve something that is considered right, but Mr.\_Bungle could argue that he has not done anything wrong, as his intentions were to simply act as his fictional character would. The difficulty in applying deontological theory within the virtual space lies in the fact that, in such incidents, we have no way of knowing what the true intentions of Mr.\_Bungle's user were. This allows the use of the role-play argument as a possible defence.

### 3.3. Consequentialism

Consequentialism exists as an opposition to deontology. The consequentialist hypothesis contends that the morality of a decision can be adjudged based on the outcome or result of that decision. In contrast to deontological theory, it maintains that it is the consequences of a particular action, rather than the intention behind the action itself, that must be considered. A complete survey of the consequentialist doctrine would be far beyond the scope of this paper. Instead, let us focus our attention on the two most prominent consequentialist theories: ethical egoism and utilitarianism. Ethical egoism supports the idea that all individuals should base moral judgements exclusively upon their own self-interest. Many egoists maintain that this is how all individuals act anyway, even if subconsciously. They argue that, even when someone performs an action that, on the surface, might be in the interest of someone else, they only do so to augment their own personal self-worth. While the fact that many people take some satisfaction from their own acts of altruism is difficult to contradict, it can be argued that this theory is nonetheless flawed. Acts of altruism can encompass personal satisfaction, but consider the performance of split second heroics, where the individual who behaves altruistically does not have sufficient time with which to consider the implications in relation to his own personal satisfaction and simply act out of interest for another. How does ethical egoism apply to the *LambdaMOO* incident? Before answering this, it might be worth looking at utilitarianism, the other major consequentialist theory.

Utilitarianism was first proposed by Hume, and holds that an action is right if the consequence of that action leads to the greatest good for the greatest number. Various forms of utilitarian theory have been developed by contemporary philosophers, but they all adhere, generally, to this founding principle: "The creed which accepts as the foundation of morals, Utility, or the Greatest Happiness

Principle, holds that actions are right in proportion as they tend to promote happiness, wrong as they tend to produce the reverse of happiness” (Mill, 2007). There are many flavours to the utilitarian thesis, such as hedonism and its focus on pleasure. Many of the criticisms directed toward this theory are focused on conflicts of interpretation. The notion of happiness is not a constant for everyone. What is happiness? Ask several thousand different people, and you will most likely receive several thousand different answers. Adaptations of the original theory that seek to identify the greatest good are also too dependent on interpretation. Who decides what is the greatest good? A focus on the specifics of the various nuances of consequentialist theory is not necessary: whether or not the ideology could be useful in the virtual world is more relevant to the discussion at hand.

In the application of the consequentialist approach to the *LambdaMOO* incident, the major difference from the previous theories is that the role-play argument no longer seems valid. Consequentialist theory removes this possible conceptual excuse from Mr. Bungle's denial, as now it is the result of the act, which includes the victimisation of the other individuals, that is relevant. Whether or not Mr. Bungle's motives were to deliver a good role-play experience no longer matters. What matters is that the result of his actions was damaging to others. Here, we can see that the difficulties that arose in the application of deontological theory have been overcome. On the surface, it would appear that the consequentialist approach is best suited to combating the role-play argument, but a more thorough examination is required before such a conclusion could be drawn. It is necessary to look at the specific hypotheses and the results of their application. For example, if one takes the egoist approach, you are presented with a conflict of interest. Do we satisfy the interests of the role-player or the interests of those who may become victim to hardcore manifestations of such? It might not be possible to provide satisfaction for both parties. Similar to virtue theory, utilitarianism is somewhat overly vague in its definition. It does not seem realistic to suggest, as the *LambdaMOO* incident demonstrates, that the happiness of hardcore role-players can be fulfilled alongside the more casual users of virtual environments. Perhaps this line of thought is reflected somewhat in the existence of dedicated role-play servers within some online communities: a conscious effort by developers to separate hardcore role-players from more casual users.

#### 4. New Theory for New Societies

The application of moral codes, originally proposed in a real-world context, do not fit ideally within the virtual space. All moral philosophies are open to criticism in some respect, but it is even more evident here, as they were not designed with the new societies of the modern era in mind. The dilemma presented by this is that, while ethical issues transcend the boundary between reality and its virtual counterpart, the moral philosophies used to approach such issues do not transfer so readily. Of the normative theories, I would suggest that the most promising, so far, is the consequentialist approach, though a specific variation of its core principles should perhaps be developed. The emphasis that consequentialism places on the result of an action rather than on the act itself, seems to provide a basis for arguing against the defence offered by the role-play argument, and so merits further

consideration in the virtual arena. Thought should also be given to some of the more modern variants of social contact theory, such as John Rawl's theories on social justice.

What is required, ideally, however, is a new theory, a moral philosophy developed for the virtual space, with the difficulties presented by the role-play argument in mind. I suggest that such a theory would have to take its origins in the consequentialist school of thought, perhaps a form of “virtual consequentialism”. The acceptance of such a philosophy by users of virtual environments might prove problematic, but it would be best to focus on such a dilemma after a dedicated theory has been constructed. In the development of such a theory, it is important that the focus is placed on the notion of a “virtual inhabitant”. With such a focus, one could overcome the difficulties that arise in existing philosophies that were not devised with the role-play argument as a consideration. The virtual inhabitant is comprised of the user's consciousness and the digital representation of this. This construct of the virtual inhabitant acknowledges the delicate attachment formed between users and their virtual persona. By accepting this construct, we have the foundation upon which an effective theory of virtual consequentialism can be built, as we are considering both the in-game representation of a character and the effects that actions within the virtual space can have upon the real-world user behind that character. By taking this approach, those who exist within virtual worlds can be held morally accountable for their actions. The strength of the role-play defence will be negated because we are considering the consequences for the virtual inhabitant, the components of which includes real people in the real-world. This is perhaps the foundation upon which a new moral theory for the new virtual societies of the Digital Age can be built.

## 5. References

Anscombe, E. (1958), “Modern Moral Philosophy”, *Philosophy*, Vol. 33, No.124, pp1-19.

Arendt, H. (1972), *The Crises of the Republic*, Harcourt Publishers Ltd, New York, ISBN: 0-15-623200-6.

Blackburn, S. (2008), *The Oxford Dictionary of Philosophy*, Oxford University Press, New York, ISBN: 978-0-19-954143-0.

Dibbell, J. (1999), *My Tiny Life: Crime and Passion in a Virtual World*, Fourth Estate, London, ISBN: 1-84115-057-6.

Johnson, D.G. (2003), *Computer Ethics: International Edition: Analyzing Information Technology*, Pearson Education, New Jersey, ISBN: 0-13-123022-0.

Kenny, A. (2000), *The Oxford History of Western Philosophy*, Oxford University Press, Oxford, ISBN: 0192854402.

Mill, J.S. (2007), *Utilitarianism, Liberty & Representative Government*, Wildside Press, Maryland, ISBN: 978-1434496003.

Rachels, J. (2002), *The Elements of Moral Philosophy*, McGraw-Hill Higher Education, New York, ISBN: 978-0-07-312547-3.

Schroeder, R. (2002), *The Social Life of Avatars*, Springer, London, ISBN: 1-85233-461-4.

Wolfendale, J. (2006), "My avatar, my self: Virtual harm and attachment", *Ethics and Information Technology*, Vol. 9, No. 2, pp.111-119.

# Behavioural Biometric Authentication for Mobile Devices

H. Saevane, N.L Clarke and S.M Furnell

Centre for Security, Communications and Network Research, University of Plymouth, Plymouth, United Kingdom

e-mail: hataichanok.saevane@plymouth.ac.uk

## Abstract

It is commonly acknowledged that mobile devices now form an integral part of an individual's everyday life. As the amount of valuable and sensitive information stored on a mobile device increases, so does the need for effective security. In order to protect unauthorised access, an authentication system is required. Biometric authentication has proven to be a more reliable solution than knowledge based and token based techniques. Indeed, biometric techniques are uniquely individual, impossible to forget or lose, difficult to reproduce or falsify and difficult to change or hide. Despite the well known advantages of biometric authentication approaches, the majority of current state-of-the-art mobile devices embrace point of entry authentication systems including PIN/passwords and one time fingerprint verification. This paper begins by discussing the limitations of current state-of-the-art authentication approaches together with preliminary findings of an experiment using finger pressure authentication. The potential of linguistic profiling is explored and results of a secondary experiment highlighted the potential for a continuous, transparent and non-intrusive behaviour biometric authentication system for mobile devices.

## Keywords

Authentication, Transparency, Behaviour, Biometrics, Mobile Devices.

## 1. Introduction

Presently, Mobile cellular networks are currently available for 90% of the world population including people living in rural areas. Mobile devices are widespread in excess over 5 billion users (ITU, 2010). Moreover, people are moving rapidly from 2G to 3G platforms in both developed and developing countries with 48 countries offering 3G service in last 3 years. With the increasing functionality of mobile devices the number of services, applications and information accessible to the user is significantly expanding. Moreover, Mformation (2009) highlights that mobile phone are becoming more sophisticated as significant amount of information is now stored on such devices. Mformation (2009) conducted a survey amongst 4000 people who were living in the UK and US. 90% of users store telephone numbers while 65% also store address and other contact information and 48% have calendar information on their phones including digital photos, videos, music downloads. With ever-increasing phone and network capabilities, this trend of using the phone to store

valuable and sensitive data from every aspect of life is set to continue. However, one of users' biggest concerns is the risk of their device being lost or stolen. According to the same report (Mformation, 2009), 82% of users fear that if their phones were lost or stolen, someone would use the information stored on them for fraudulent purposes; 90% were worried about the loss of their personal data if a mobile device were to go missing and 40% of respondents stated that losing a mobile would be worse than losing their wallet. In order to protect valuable and sensitive information from unauthorized users, there is an ever increasing need for an effective continuous authentication system.

The authentication on mobile devices can be classified based on three fundamental mechanisms: Something you know, something you have and something you are. The first mechanism is based on something you know such as using PIN (Personal Identification Number) or Password. This technique is currently mainly implemented and offers a standard level of protection and provides cheap and quick authentication. The second mechanism is based on something you have such as token or SIM. However, the problems with these two techniques arise when the passwords or tokens are lost, stolen, or misplaced, which eventually leads to fraudulent incidents. For example the selection of weak passwords that are easy to guess or carrying the SIM card around with the mobile device to present in order to access the device.

A reliable solution to these authentication problems lies in the last mechanism, which is something you are. Biometric characteristics are uniquely individual, non-transferable to others, impossible to forget or lose, difficult to reproduce or falsify, usable with or without the knowledge/consent of the individual, difficult to change or hide. Hence, it is known to be the most secure and reliable way to establish authentication more than password and token authentication mechanisms. However, biometrics introduce their own set of problems, in terms of performance and acceptability. Moreover, current approaches are still focused upon point-of-entry authentication, which is arguably still considerably inconvenient to the end-user.

The aim of this paper is to investigate the behavioural biometric techniques that can be applied to authentication on mobile device in a transparent, continuous and non-intrusive fashion as to minimise user inconvenience and enable authentication to be performed beyond point-of-entry (e.g. PIN/passwords). Section 2 provides an overview of biometric authentication. Sections 3 and 4 then explore the feasibility of some specific behavioural biometrics, examining finger pressure and linguistic profiling. Section 5 discusses the potential biometric techniques for use in mobile authentication. Finally, conclusions and future work are presented in Section 6.

## **2. An overview of biometric authentication**

The International Biometrics Group (IBG) defines biometrics simply as “the automated use of physiological or behavioural characteristics to determine or verify identity” (IBG, 2006). Physiological biometrics perform authentication based on bodily characteristics such as their fingerprint or their face. By contrast, behavioural biometrics perform authentication based on the way people do things, such as their



typing rhythm, their voice or their signature. Some existing biometric characteristics are show in Table 1.

	<b>Biometric Characteristic</b>	<b>Description of the features</b>
<b>Physiological</b>	Fingerprint	Fork and ridge patterns, pore structure
	DNA	DNA code as the carrier of human hereditary
	Facial geometry	The overall structure, shape and proportions of the face: distance between the eyes, the location of the nose and eyes, the area surrounding the cheekbones
	Iris	Iris pattern
	Retina	Pattern of vein structure at the back of the eye
	Hand geometry	Features related to a human hand, finger length, width, thickness and curvatures
<b>Behavioural</b>	Signature (dynamics)	Pressure, direction, acceleration and the length of the strokes, dynamics number of strokes and their duration
	Voice	The Voice tract and the accent
	Keystroke dynamics	Rhythm of keyboard strokes
	Odour	Chemical composition of the one's odour

**Table 1: Summary of the most well known biometric characteristics**

Physical features are likely to stay more constant over time and under different conditions, and tend to be more unified within a large population (Woodward et al, 2003) so physiological biometrics tend to be used for identification-based systems as they are considered more reliable approaches. While some behavioural biometrics have very good accuracy for verification, the identification accuracy is considerably lower as the number of users in the database becomes larger (Yamploskiy and Govindaraju, 2010). This is because users act differently depending on mood, illness, stress, previous events, environment, to name a few. For this reason, behavioural biometrics tend to be used for verification-based systems.

However, one of the potential advantages of behavioural biometrics is that they can be utilised non-intrusively and continuously during the user session. In this way, it becomes possible to extend the authentication process beyond initial point-of-entry and verify the identity in a transparent manner, without the explicit involvement of the user. Moreover, the collection of behavioural data often does not require any special hardware and is so very cost effective. Clarke and Furnell (2007) proposed a framework that uses a combination of secret based knowledge and biometric techniques to meet a number of objectives for an effective authentication approach for mobile devices:

- to increase the authentication security beyond the PINs;
- to provide user convenient by operating transparent or non-intrusive authentication that authenticate user without knowledge of user;
- to provide continuous authentication that can authenticate user during usage of device rather than simply at switch-on;
- to provide flexible architecture that able to be applied with any differing hardware configurations, processing capabilities, and varying levels of networks connectivity;

In the best case, the proposed mechanism enhances PIN/password-based authentication with keystroke analysis and can provide transparent and continuous authentication of the authorised user to increase the level of authentication beyond the standard point-of-entry PIN/password technique. However, individual biometric techniques such as keystroke analysis are not suited to all users and scenarios and also cannot provide adequate reliability. For example, although keystroke analysis can provide continuous and non-intrusive application in keyboard-intensive contexts; if keystroke analysis is not working it will adversely affect the authentication system that can be providing only point-of-entry PIN/password technique. Indeed, it should be apparent from Table 1 that even if all of the characteristics exhibited the same discriminative abilities, the resulting biometrics would not be of equal value and applicability in practical contexts. The recognition that no single biometric is ideally suited to all scenarios is an important one, and several studies show that multi-modal biometric approach is superior to any single biometric approach (Brunelli and Falavigna, 1995; Kittler et al., 1997; Poh and Korczak, 2001; Ross et al., 2001) Hence, a combination of biometric techniques should provide adequate security and greater reliability for an enhanced authentication system.

In light of the foregoing exploration, a preliminary study was conducted using a novel combination of finger pressure and linguistic profiling was undertaken.

### **3. Studying the feasibility of Finger Pressure**

According to the research of Grabham (2008), the study of a biometric based on pressure and key press duration of a user entering a PIN on an ATM type interface coupled with a component-wise verification scheme was determined. The results of this research showed that using pressure and key press duration can identify users with high accuracy and low error rate. Therefore, the feasibility of finger pressure applied to a notebook touchpad was used to simulate a mobile touch screen. Details of the experiment are explained in the subsections that follow.

#### **3.1. Experimental procedure**

In this case study, the biometric information, keystroke dynamics (i.e. typing rhythms) and finger pressure (i.e. the force applied over the finger position) were captured when a user interacts with a notebook touchpad. Keystroke dynamics can be extracted into two features: inter-key which is the duration of interval between two successive keys, and hold-time which is the duration of interval between the pressing and releasing of a single key. A total of 10 participants (n=10; female=6,

male=4) were asked to enter their cell phone numbers on 12 keys simulated on a notebook touch pad that will be recorded every 20 milliseconds, with 10 digits long, 30 times continuously and repeatedly.

This research was studied into two scenarios, namely using individual characteristics and combination of characteristics. The pattern classification process was developed using the *K*-means classification algorithm. The input to neural network depended upon the scenario with which it was evaluating.

### 3.2. Results

The results of the study on individual characteristics and combination biometric characteristics are showed in Table 2. Hold-time has the lowest rate of false acceptance of unauthorised users (FAR) (22.59%) and false rejection rates of authorised users (FRR) (0%). These findings illustrate that using hold-time as the key to identify users is the most effective individual measurement. In the case of combination biometric characteristics, the results show that ‘The Best User’ is obtained from the concatenation of hold-time and finger pressure input scenario, FAR 11.48% and FRR 0%. However, the combination of three biometric characteristics together with the combination of hold-time and inter-key time values could also be applied to identify users with the results of FAR 21.48% and FRR 0% respectively.

	The Best User		The Worst User		Average	
	%FAR	%FRR	%FAR	%FRR	%FAR	%FRR
Hold-time (H)	22.6	0	55.9	6.7	52.2	1.0
Interkey-time (I)	28.1	0	33.7	50.0	49	21.7
Finger Pressure (F)	41.8	0	47.4	3.3	44.8	3.0
HI	21.5	0	68.5	10.0	54.0	3.3
HF	11.5	0	77.8	3.3	64.2	0.3
HIP	21.5	0	67.8	3.3	53.8	2.7

**Table 2: Results of individual and combination biometric characteristics**

## 4. Studying the feasibility of Linguistic Profiling

Linguistic profiling has certainly shown its worth for authorship verification and recognition (Halteren, 2004). Hence, this experiment investigated the feasibility of using linguistic profiling to profile and discriminate between users. Previous studies (Yoon et al., 2010) have revealed that the majority of mobile subscribers use abbreviated and phonetically adapted words when interacting with text based communication facilities on mobile devices (i.e. SMS, Mobile Instant Messengers, and Email), and so this presents a potential opportunity for profiling based on patterns of text based communication.

#### 4.1. Experimental procedure

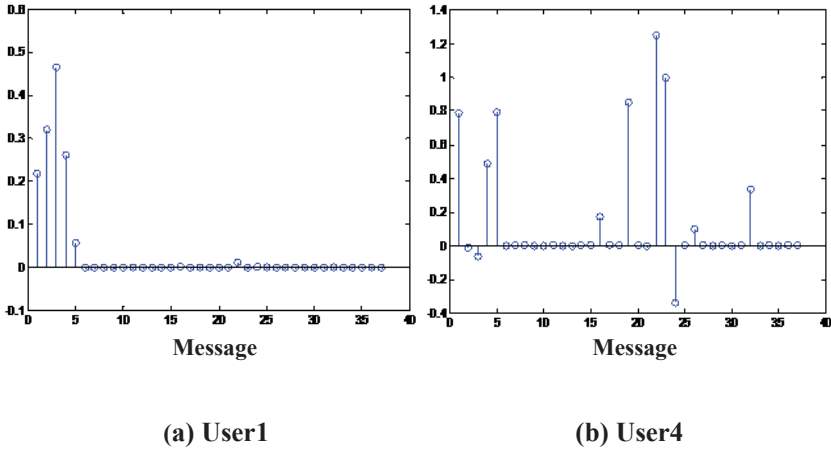
In order to analyse the effectiveness of using text based authentication, a real time SMS simulation program was compiled in Visual Basic and deployed onto two Smartphone's. The program enabled text based communication between pairs of participants using a Bluetooth communication channel. A total of 30 participants were required to send at least 15 messages each to the other participant on a subject of their choice using a non-predictive text input method. The messages were saved in a text file prior to transmission.

In linguistic profiling, many types of linguistic features can be profiled such as vocabulary, information content or item distribution through a text. According to (Yoon et al., 2010), abbreviation and emotional words (e.g. wow, hehehe, oh) are used more frequently in SMS messages so that abbreviation and emotional profiles will be used to create user profiles including every possible type of feature. Discriminating characteristics include message length, word length, average of number of words per message, and number of symbols, digits and capital letters.

The pattern used for the classification process is dependent upon the context to which it was evaluating. For example to authentication user1, the total message will count number of words found in linguistic profiling of user1.

#### 4.2. Results

The preliminary findings from the experiment were analysed by statistic and classification techniques to study the feasibility of classification using linguistic profiling. To study the complexities of successfully discriminating between the users, mean and standard deviation were analysed to calculate the spread value. The spread of values, the range of a users input vectors that reside between lower (mean minus a standard deviation) and upper (mean plus a standard deviation), showed that users input vectors are more likely to be similar, or within similar boundaries as other users, which means it will make classification more difficult. However, the findings were positive in that linguistic profiling can indeed be used to discriminate for some users. For example, using a combination of number of words, number of sentences, number of full stops and question marks features analysed using Radial Basis Function (RBF) with 76 messages that were used for training and 37 messages were used for testing. Figure 1 clearly illustrates that the aforementioned characteristics could be used successfully to discriminate User1 from a total of 5 users (a), however this was not the case for User 4 (b) which clearly shows similarities between participants.



**Figure 1: Result of classification using Radial Basis Function**

Table 3 shows that using *K*-means classification technique elicited the best result with FAR = 17% and FRR = 13%. Table 4 shows this was achieved by using abbreviation and emotional based profiling.

User #	Good User 1	Good User 12	Bad User 7	Bad User 20	Average
Valid Attempts	15	15	14	15	16.7
Invalid Attempts	486	486	487	486	484.3
%FAR	17.1	10.5	93.4	92.2	23.4
%FRR	13.3	20.0	28.6	46.7	43.9

**Table 3 Result of classification using *K*-means classification technique**

User #	Abbreviation Profile	Emotional Profile
1	's', 'u', 'ur', 'fr', 'bout', 'hvnt', 'b4', 'hv', 'fav', 'i've', 'hvn't', 'yr'	'haha', 'owh', 'yeah', 'erm', '...'
12	'u', 'cwk', 'q', 'c', 'txt', 'r', 'abt', 'x', 'ok'	'lol', 'xx', 'hey', 'aww', 'um', 'yeah', '☺', '...'
7	'u'	'wow', 'hehe', 'ok', 'erm', '...'
20	'i've', 'i'd', 'id', 'x'	'oh', 'haha', 'yeah', 'awesome', '...'

**Table 4 Example of Linguistic Profiles**

## 5. Discussion

The preliminary studies undertaken using behavioural biometrics, keystroke analysis and finger pressure, show that using a combination of hold-time and finger pressure gave the lowest error rates and improving upon the findings from Grabham (2008).

The touch screen interface used in the finger pressure experiment used an interval range of 0 – 255. This range was considered to be very limiting and would prove ineffective in discriminating between a large number of users or participants. To this end, it is envisaged that the greater number of participants using this technique would result in a greater number of matches and false positives. In addition, this technique is likely to produce many false negatives, as the pressure applied by the end-user would be influenced by individual mood and energy levels.

The results in the feasibility study of linguistic profiling showed low error rates using abbreviation or emotional based profiling. Participants (e.g. ‘Good User’) who used a great number of abbreviated or emotional words produced significantly lower error rates. However, participants who used the same common abbreviation and emotional words (e.g. ‘wow’, ‘u’) tended to produce higher error rates. Therefore, further analysis is required in order to determine the best discriminating features. The potential advantage of behavioural biometrics is that they can be utilised non-intrusively and continuously during the user session, thereby creating an authentication process beyond initial point-of-entry.

## **6. Conclusions and future work**

To extend the point of entry authentication mechanism currently used on mobile devices, a combination of biometric techniques is considered to maximise the potential for reliability and security. Having explored finger pressure and linguistic profiling for use in mobile devices in section 3 and 4, it is proposed that behavioural biometrics can provide transparent (non-intrusive) and continuous authentication. Moreover, behavioural biometrics, keystroke dynamics and linguistic profiling do not require any additional hardware, therefore reducing overhead costs.

Subsequent to the preliminary experiment using finger pressure, limitations concerning participant mood, tiredness and the need for specific hardware were considered. In addition, current state of the art pen based TouchPads are unable to measure the pressure of pen contact as they report all pen strokes with a constant value (Synaptics, 2001). In order to overcome these limitations linguistic profiling was explored.

The next step in this research is to further analyse the linguistic profile dataset in order to identify the most effective text based discriminators. Once complete the findings will be used to develop a multi-tier behavioural biometric authentication system to provide reliability and security to a wide range of mobile devices within any given mobile environment. The proposed framework should be flexible and scalable in that it can adopt other biometric techniques. Moreover, the system can integrate new techniques or new biometric techniques without having to change the overall system design.

## 7. References

- Brunelli, R. and Falavigna, D. (1995), "Personal Identification using Multiple Cues", *IEEE Transaction on Pattern Analysis and Machine Intelligence*, Volume 17, Number 10, October 1995, pp. 955-966, doi:10.1109/34.464560
- Clarke, N. and Furnell, S.M. (2007), "Advanced user authentication for mobile devices", *Computer and Security*, Volume 26, Number 2, March 2007, pp.109-119, doi:10.1016/j.cose.2006.08.008
- Grabham, N. and White, N. (2008), "Use of a Novel Keypad Biometric for Enhanced User Identity Verification", 2008 *IEEE International Instrumentation and Measurement Technology Conference*, Victoria, British Columbia, Canada, 2008, pp.12-15
- Halteren, H. (2004), "Linguistic Profiling for Author Recognition and Verification", *Proceedings of the 42nd Annual Meeting on Association for Computational Linguistics (ACL 04)*, Association for Computational Linguistics, Morristown, NJ, USA, doi: 10.3115/1218955.1218981 <http://dx.doi.org/10.3115/1218955.1218981>
- IBG (2006), "Which is the best biometric technology", International Biometric Group, [http://www.biometricgroup.com/reports/public/reports/best\\_biometric.html](http://www.biometricgroup.com/reports/public/reports/best_biometric.html) (Accessed 4 January 2009)
- ITU (2010), "The World in 2010: ICT Facts and Figures", <http://www.itu.int/ITU-D/ict/material/FactsFigures2010.pdf>. (Accessed 4 January 2009)
- Kittler, J., Matas, J., Jonsson, K. and Ramos Sanchez, M. U. (1997), "Combining Evidence in Personal Identity Verification Systems", *Pattern Recognition Letters*, Volume 18, Number 9, pp.845-852, doi: 10.1016/S0167-8655(97)00062-7
- Mformation (2009), "Mformation-sponsored survey reveals mobile users worried about loss and mobile fraud", <http://www.mformation.com/mformation-news/press-releases/mformation-sponsored-survey-reveals-mobile-users-worried-about-loss-and-mobile-fraud>. (Accessed 10 November 2010)
- Poh, N. and Korczak, J. (2001), "Hybrid Biometric Authentication System Using Face and Voice Features", *Lecture Notes in Computer Science, Volume 2091/2001*, pp. 348-353, doi: 10.1007/3-540-45344-x\_51
- Ross, A., Jain A. and Qian, J-Z. (2001), "Information Fusion in Biometrics". *Proceedings of the 3rd International Conference on Automatic Face and Gesture Recognition*, Springer-Verlag, London, UK, pp. 354-359 ISBN: 3-540-42216-1
- Synaptics (2001), "Synaptics TouchPad Interfacing Guide", <http://www.synaptics.com/developers/manuals> (Accessed 29 May 2008)
- Woodward, J.D, Orlans, N., Higgins, P. (2003), "Identity Assurance in the Information Age" *McGraw-Hill/Osborne*, Berkeley, California, ISBN 0-07-22227-1
- Yamploskiy, R.V. and Govindaraju V. (2010), "Chapter 1 Taxonomy of Behavioural Biometrics". *Behavioral Biometrics for Human Identification: Intelligent Applications*, 2010, doi: 10.4018/978-1-60566-725-6

Yoon, J. W., Kim, H. and Huh, J.H. (2010), "Hybrid spam filtering for mobile communication", *Computers and Security*, Volume 29, Number 4, pp.446-459, doi:10.1016/j.cose.2009.11.003



# Developing a climate change visualization tool using Google SketchUp

William Lynn, Paul Walsh, Helen Fagan

Math & Computing, Cork Institute of Technology, Ireland  
e-mail lynnwilliam@gmail.com

## Abstract

Climate change poses a serious threat to urban and coastal development. The use of scenarios to develop multiple possible future outcomes is used to desensitize planners and decision makers. These possible scenarios are created as visualizations using Google SketchUp and video game technology. A set of plug-ins was developed for SketchUp that allows urban planners, planners and geologists to quickly create their own climate change urban flooding visualizations. The plug-in is implemented as a tool bar that allows the creation of urban flooding and environments and for the user to experience the climate change world using a video game engine. The current methods of creating visualizations using 3D modeling tools and game technology is reviewed; and combined together to form a single application for the user.

## Keywords

Climate change, scenarios, flooding, game design, 3D modelling, Google SketchUp

## 1. Introduction

### 1.1 Climate change scenario development

Climate change is already happening and represents one of the greatest environmental, social and economic threats facing the planet (EU 2010). Climate change is an important issue affecting people and organizations worldwide. The use of scenarios to develop multiple possible future outcomes is used to desensitize planners and decision makers. Climate change software is a relatively new field and ways of adapting existing software are reviewed.

### 1.2 Climate change scenarios

Scenarios were originally developed in the 1960s as a way of developing abstract thinking and decision making by the Shell oil corporation. Instead of trying to 'predict the future', scenario exercises were designed to sensitize an organization to a wide range of possible futures (Zurek et al 2007). □Scenarios are not predictions or simulations of climate change; they are plausible descriptions of how the future might develop, using current information and assumptions about future trends. They also help to explore the differing outcomes that might result if basic assumptions are

changed (Pulver et al, 2007) . Climate change scenarios are being developed within the IMCORE (IMCORE 2010) project and the visualization of urban flooding is one output. Urban flooding makes use of existing cities using different flooding models.

### 1.3 Visualizations

Visualizations are excellent ways of expressing the methods, scenarios and outcomes (Brown et al, 2006) of climate change. The 2D, 3D or 4D visualization can be shown to public or specific audiences and this enables complex information to be understood. The visualizations promote instant feedback and discussion and can be an invaluable as a decision support tool.

### 1.4 3D modeling tools

3D modeling tools allow for the creation of complex realistic environments for climate change visualizations. The output from these applications (the 3D models) can they be used in video games, GIS (ArcGIS 2010), simulation (Creator 2010) (Kongsberg 2010) and cultural heritage (Yastikli et al,2003) research.

The modeling tools allow for complex 3D structures to be created and textures to be assigned. There are many open source 3D modeling tools (Blender 2010) (K3d 2010) (Softimage 2010). Not all modeling tools require the same level of training, some have advanced features materials, mesh displacement, animation) that require training (Autodesk StudioMax 2010) (Blender 2010). Others have basic features (push/pull modeling) and require less training (Google Sketchup 2010). In this research modeling tools and GIS data are used to create 3D content for the climate change scenario visualizations.

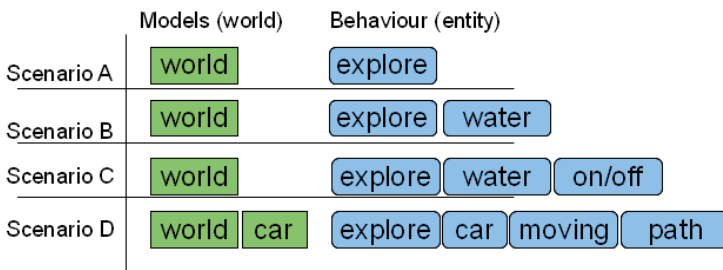
### 1.5 Game design

Computer games allow for complex interactions of narratives (animation, dialogue, interaction, changes over time) to be experienced by the user. The game genre for this research is first person shooter. This allows for a real-time narrative; where the story is narrated by one character at a time. In video games, first person refers to a graphical perspective rendered from the viewpoint of the player character.

### 1.6 Level editor tools

□Level editor tools are used in game design to create the world and describe the behavior of the elements in the world. These tools describe changes that will happen over time to the models in the world. They also allow the description of events and how these affect models over time. When defining the behavior it is necessary to express it's behavior as entities, or the smallest units of interaction (Taylor et al, 2006). A car driving along a flooded road has the following elements (car, road, flooding) and the entities required would be; a car as a 3D model, road as 3D model and a list of paths for the car, flooding as body of water. □Diagram 1.1 outlines how the 3D models and entities are used in basic scenarios.

The video game engine displays the 3D world with its defined behavior and allows for the user to take an active role in determining the unfolding narrative.



**Diagram 1.1 Scenarios with 3D model and behavioral entities**

## 1.7 Entities

□The level editing tool contains an entity for anything that can be changed over time in the scenario e.g. water, sky and traffic etc. An entity in the level editor is defined as a 3D box in the world with a list of attributes. The attributes for a light entity could be brightness and color along with it's 3D placeholder in the world. A water entity would have a 3D box in the world representing it; with color and height attributes.

A tool can be used to create scenarios if it has the following high-level functionality.

- 3D modeling capability to create an urban or coastal environment
- Level editor capability to create entities and define the relationships and interactions between them.
- A game engine that can render the world and the required behavior and allows the user some interaction with the world.

## 2. Proposed Solution

As discussed 3D modeling tools are used to create the world, level editor tools are used to define the scenario behavior and interactions; and the game engine renders the world and allows the user interact with it.

This separation of the content tools and the level editor are narrowing (Nelson, 2007), so one tool can be used to create the 3D world and the behavior (UDK 2010) (Crytek 2010). However there is still a gap where 3D modeling tools (Autodesk StudioMax 2010) are needed to create advanced models i.e. humans and their animations. The combination of tools makes the creation of the world and describing behavior more intuitive and user friendly.

Google SketchUp is a 3D modeling tool with relatively basic features but it is used across a variety of user types: geologists, game designers and urban planners. As this is the tool of choice of many urban designers; it is the aim of this research to enhance Google SketchUp to include level editor functionality. This in turn will allow the urban planner to specify their urban worlds and a climate-flooding scenario that they wish to see played out in that world.

This research extends Google SketchUp with a custom built level editor plug-in called RainBath. It is created using the Ruby programming language and allows the user do the following:

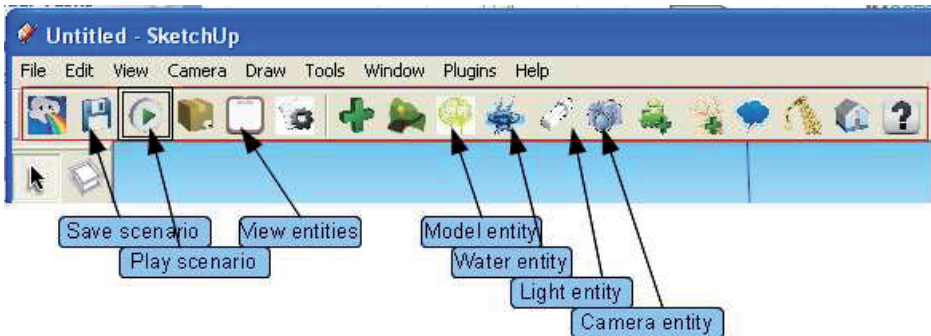
1. Define a scenario by specifying entities from a toolbar within SketchUp.
2. Enable the user to play the scenario directly from the SketchUp environment using a Play button on the new toolbar.

## 2.1 The Solution

### Enhance Google SketchUp

To allow the user create, edit and delete entity functionality, a RainBath toolbar was developed for Google SketchUp see diagram 1.2 The play button outlined in black is used to launch the game engine and allows the user to interact with the scenario. Each type of entity that the user may create also has it's own button.

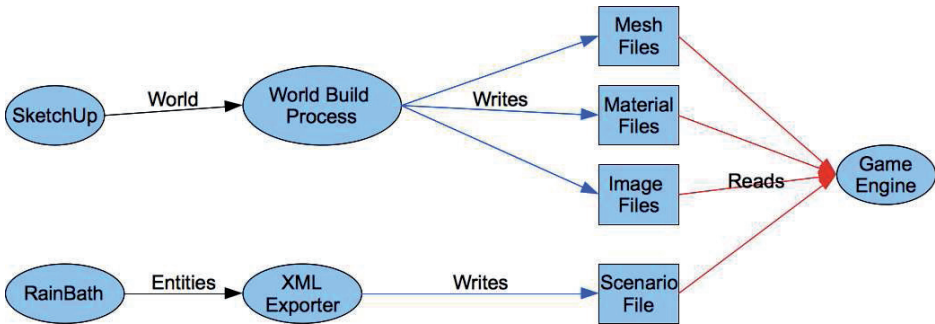
Whenever the user makes changes to the current scenario; the world and its entities must be converted into a format the game engine can interpret and display. This conversion is known as the World Build Process and is executed every time the user plays a modified scenario.



**Diagram 1.2 RainBath toolbar plug-ins in SketchUp**

### Google SketchUp and RainBath Interface

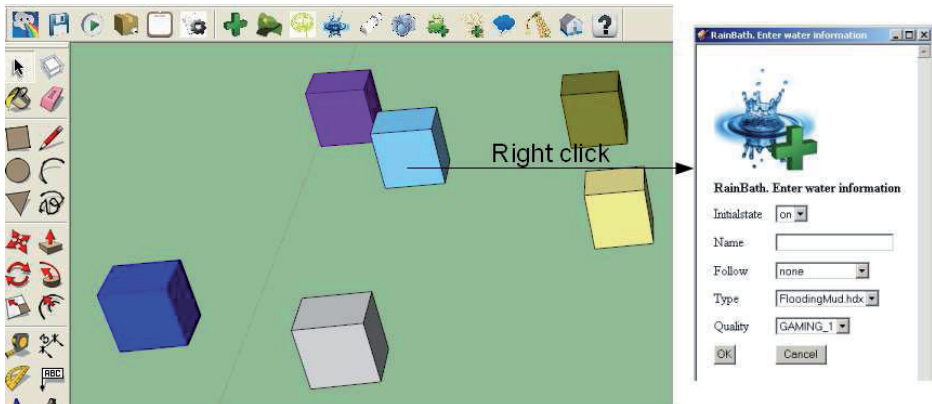
The 3D world is created in the SketchUp environment and stored in it's native skp file format. The world needs to be converted into a format that the game engine can read each time the world is played. The SketchUp world goes through the world build process to convert the world into a scene-graph. This uses the MeshToOgre open source tool which also exports the textures and materials information.



**Diagram 1.3** RainBath and Game engine interaction.

The behaviour exhibited in a scenario is defined by adding entities in the SketchUp environment. In SketchUp entities are denoted as colored boxes see diagram 1.4. Each entity box has a set of unique properties that can be configured by the user e.g. the water entity has wave and height information and is presented to the user using forms see diagram 1.4. This information that determines the narrative is exported by Rainbath to the .scenario file and loaded by the game engine when the world is played.

The engine thus needs to be able to read the scenario, mesh, images and materials source files in order to run the scenario.



**Diagram 1.4** Representation of entities in SketchUp.

### Format of scenario file

XML is heavily used in the game development industry, notably VRML (virtual reality markup language). The scenario file contains all the entities in the scenario that outline the users interaction in the game engine. The entities are stored in this file as XML.

### 3. The Implementation

RainBath combines the level editor and the 3D modeling tool into a single application but the structure of the communication needs to be outlined. The RainBath level editor writes a scenario file that is an XML structured document which contains all the entities in the world and their relationships. If the entity has an associated model it contains a link to the appropriate mesh file that is read by the engine. The scenario file contains exact definitions of all entities and contains links to the models and world the scenario uses; see diagram 1.3.

#### 3.1 Subset of Ruby does not support XML

The subset of Ruby used by Google SketchUp does not support XML reading and writing.

It was decided to have each entity e.g. light object write its own XML, each entity class implements `String getXMLString()` and `Object readXMLString(String)`. Each entity object also contains all the tags needed to write its data. A centralized XML class pattern is not used because it is more likely in this research that new entities would be created or modified instead of changing the XML writer/parser class.

#### 3.2 The game engine parsing XML

The scenario file contains all the data about the entities and the world. The structure of the file is that each entity type is written sequentially which is suited to SAX XML parsing, as the entities are always written in the same order. This sequential order is beneficial, as the engine can sort the list of the 3D models needed before loading them into memory.

The game engine was written in C++ using the Ogre API, our own extensions were used in the engine implementation which is not in the scope of this paper. The engine parses the scenario file, loads the entity information and sets up the scene-graph for the scenario visualization.

#### 3.3 Creating the entities

It is important that the user create entities from within Google SketchUp, entities are stored as 3D boxes in the world with a color and a position. The color is determined by the entity type and each box also contains a pointer to a list of attributes that describe the entity.

These entity attributes are stored automatically in the SketchUp file. In the game engine we will not be interested in viewing these particular entity boxes as they are simply placeholders.

The position of the entity in the world is important, the user might need to create a light entity at some strategic position in the scenario. The initial position of an entity

can be set by moving the camera in the SketchUp view to the required position, and then use the create entity button on the toolbar, the entity is then placed at the camera's position.

### 3.4 Editing the entities

The entities in SketchUp are represented as colored boxes see diagram 1.4; with specific attributes. When the user right clicks on these boxes; the properties are looked up internally using the list and the attributes are displayed in a dialogue box for the user to edit.

When the user makes changes e.g. changes the name of an entity; the associated attribute is changed; then on saving they are synchronized to the scenario file and an internal dictionary in SketchUp.

### 3.5 Writing the Scenario file

The .scenario file only contains the basic scenario information and a list of all the associated entities and their attributes. The attributes may refer to other entities or models within the world

Writing the .scenario file is trivial, the iterator pattern is used call each entity's `getXMLstring()` methods. Each entity is then written on a new line in the .scenario file.

### 3.6 Storing Entities in the SketchUp file

When the world is played RainBath writes a .scenario file that describes all the entities but we also wanted the entities to be stored as part of the SketchUp data. It was necessary to implement storing the entities into the skp format. SketchUp allows the saving of key value pairs into dictionary's within the skp file, thus each entity has it's XML written as a key value pair to this dictionary. This allows for the world and entities to be saved in the one file. The entities data inside the skp file is not readable by SketchUp and still needs the RainBath plug-in to be extracted and displayed. In this approach the entities are stored in 2 places, the primary location is within the skp file and the secondary location is in the .scenario file that is read by the engine. The same XML format is used in both places.

## 4. Results

The custom RainBath toolbar within Google SketchUp allows the user to quickly create, edit or delete entities such as water flooding, camera, models and trains. The entities are represented as 3D boxes in the world and dialogue forms are displayed to configure their attributes.

The entity GUI can be used to create multiple urban flooding scenario visualizations, and the play button in the integrated toolbar is used to immediately play them in the game engine.

The RainBath plug-in allows for each entity to be stored as XML, these are written as .scenario files that are read by the game engine and also in internal dictionaries within the SketchUp file format. The encapsulation of the entities in the SketchUp format allows the world and entities to be saved in the same file and used in any version of SketchUp.

Testing was carried out with 20 users (geologists, climate change experts and urban planners) who were able to create their own flooding visualization in an urban environment. However the testing is outside the scope of this paper. Diagram 1.5 shows a screen-shot of the game engine visualization, of an urban flooding scenario in Cork city of approximately 12 inches. The urban world and entities were created in the SketchUp-RainBath environment.



**Diagram 1.5** engine rendering climate change entities and models from SketchUp.

### **Future work**

The aim would be to add new entities to SketchUp to allow for more climate change behavior, rain and precipitation.

### **Acknowledgments**

Dr Paul Walsh, Helen Fagan, the sketchucation community, TinyXML (Lee Thomason) and SketchUp to Ogre mesh (Fabrizio Nunnari).



## 5. Conclusion

Climate change poses a serious threat to urban and coastal development. The use of scenarios to develop multiple possible future outcomes is used to desensitize planners and decision makers. Content for visualizations is normally created using 3D modeling tools, but these do not support complex climate change behavior like flooding. To support climate change flooding, video game technology is needed. Level editors are game design tools used to create the 3D world and behavior, the other third party tools are using to create complex 3D animations. The separation of level editing tools and 3D modeling tools means that users normally require prior training, it was decided to merge these two tools together.

To allow the planners and decision makers to create the visualizations a plug-in was developed called RainBath for Google SketchUp; this allows for the construction of climate change behavior e.g. vehicles, 3D models, light and water from a toolbar. This RainBath tool allows SketchUp to be used as both a 3D modeling tool and a level editor.

SketchUp sports a subset of Ruby but does not support writing and parsing XML. Each entity implements their own reading and writing of the XML.

Each entity is stored in a dictionary in the native SketchUp skp file format; using it's own XML representation. The SketchUp world and entities can then be stored in the one skp file.

The scenario visualization is rendered by games engine technology, the 3D model and entity information is exported from SketchUp into our native .scenario XML file. The .scenario file is an XML list of entity behavior and references to 3D models created in SketchUp.

## 6. References

EU Web Site (2010), [online], available at

[http://ec.europa.eu/environment/climat/home\\_en.htm](http://ec.europa.eu/environment/climat/home_en.htm). (Accessed November 2010)

Thomason L., TinyXML project Web Site (2009), available at

<http://www.grinninglizard.com/tinyxml/>. (Accessed 01/11/10)

Ruby project Web Site (2009), Standard Library Documentation [online], available at

<http://ruby-doc.org/stdlib/>. (Accessed 01/11/10)

Zurek M.B. and Henrichs T. (2007), "Linking scenarios across geographical scales in international environmental assessments", *Science Direct [online]*, available at

<http://dx.doi.org/10.1016/j.techfore.2006.11.005> (Accessed November 2010)

IMCORE project Web Site (2010), Innovative Management for Europe's Changing Coastal Resource [online], available at <http://imcore.eu>. (Accessed 01/11/10)

Autodesk product Gmax Web Site (2010), Gmax Free Download [online], available at

<http://www.turbosquid.com/gmax>. (Accessed 01/11/10)

Presagis product Creator Web Site (2010), Creator Presagis [online], available at

[http://www.presagis.com/products\\_services/products/ms/content\\_creation/creator/](http://www.presagis.com/products_services/products/ms/content_creation/creator/). (Accessed 01/11/10)

Autodesk product 3D StudioMax Web Site (2010), 3D Modeling Animation Rendering [online], available at <http://usa.autodesk.com/adsk/servlet/pc/index?siteID=123112&id=13567410>. (Accessed 01/11/10)

Nguyen Z. and Wong S. B. (2002), “Design Patterns for Games”, *SIGCSE 2002*, Dept. of Computer Science. Rice University. Houston, TX 77005

Nelson J.M. and Mateas M. (2007), “An Interactive Game-Design Assistant”, *ACM Digital Library*, [online], available at <http://portal.acm.org/citation.cfm?id=1378786>, (Accessed November 2010)

Taylor M. J., Gresty D. and Baskett M. (2006), “Computer Game-Flow Design”, *ACM Digital Library*, available at <http://portal.acm.org/citation.cfm?id=1111300>, (Accessed November 2010)

Yastıklı N., Emem O and Alkis Z. (2003), “3D Model Generation and Visualization of Cultural Heritage”, *CIPA [online]*, available at <http://cipa.icomos.org/text%20files/antalya/77.pdf>. (Accessed November 2010),

Autodesk product Softimage Web Site (2010), Autodesk Softimage [online], available at <http://usa.autodesk.com/adsk/servlet/pc/index?siteID=123112&id=13571168>. (Accessed November 2010).

Pulver S. and VanDeveer S. (2007), “Global Environmental Futures - Interrogating the Practice and Politics of Scenarios”, *Watson Institute [online]*, available at <http://www.watsoninstitute.org/ge/scenarios/pubs/Backgrounder%20for%20Scenarios%20Workshop.pdf>. (Accessed November 2010).

Brown I., Jude S., Koukoulas S., Nicholls R., Dickson M. Walkden M. (2006), “Dynamic simulation and visualization of coastal erosion”. *Science Direct [online]*, available at <http://dx.doi.org/10.1016/j.compenvurbsys.2005.08.002>. (Accessed November 2010).

HRXML project Web Site (2010), XML Consortium [online], available at <http://www.hr-xml.org/hr-xml/wms/hr-xml-1-org/index.php?language=2>. (Accessed 01/11/10)

UDK product Web Site (2010), UDK [online], available at <http://udn.epicgames.com/Three/UDKLevelCreationHome.html>. (Accessed 01/11/10)

Crytek product Web Site (2010), Crytek [online], available at <http://crytek.com/cryengine/cryengine3/overview>. (Accessed 01/11/10)

# **An evaluation of the technologies and methods for the determination of mean flows in open channels for assessment of suitability for small scale (<20KW) tidal and estuary flow energy systems for local electricity provision.**

Daly T., Gibbons C., O'Reilly D.

Department of Mechanical Engineering, Cork Institute of Technology and NMCI.

## **Abstract**

The idea of extracting power from the sea and the tides goes back to the middle ages but it has gained a new impetus over the last number of years.

With the onset of climate change, which necessitates the need to reduce our CO<sub>2</sub> production, and with the need to reduce our dependence on expensive foreign fossil fuels, it is now imperative that all clean renewable sources of energy are utilized fully.

This paper is a review of methods and technologies available for the measurement of tidal flows in open channels.

This project hopes to develop a low cost alternative for assessing open channel flows with a view to determining the potential in open channels for small scale tidal energy production for local use and this paper also outlines progress made so far and future plans to further this aim.

## **Keywords**

Tidal energy, Tidal flows, Open channel, Flow measurement.

## **1 Introduction**

The drive for renewable energy has been gathering momentum in recent years for a number of reasons. It is widely recognised that fossil fuels are running out and that alternative sources of energy will need to be harnessed in the future especially as our energy requirements continue to increase annually.

Climate change has also been a catalyst in the development of alternative resources. The EU has also set targets for renewable power generation and all EU members will have to reach these targets in the coming years. The development of wind powered generators have gone some of the way towards achieving targets and technology in this sector has advanced greatly in the last number of years. There is however one major drawback with wind energy and that is the fact that the wind that powers these generators often is at its strongest when power is not required and there may be no wind available when power is in greatest demand. To emphasise this, on the 25/12/2010 peak demand for energy occurred at 12:45 and was 3848MW. Of this energy, only 213MW was supplied from wind power. However at midnight on the

same day, peak demand had dropped significantly but wind power was then supplying 1000MW of electricity (Web Eirgrid Web Site, 2010). One solution to this problem is to develop an efficient method of storing the power that is produced at off peak times for use at peak times. Pumped storage is one proposed solution which would see vast amount of water pumped into huge storage facilities when power is available but not required and then released through hydro generators at times of peak demand.

## **1.2 Tidal Energy**

Tidal energy generation may offer an opportunity to enable the precise prediction of the availability of renewable energy. Data collected from any tidal area over a period of about four weeks can be used to allow an accurate prediction of tidal flows in that area for many years. There are a number of technological issues still to be resolved before tidal stream energy can make a significant contribution to the overall energy needs of the country but there are many companies working on tidal generation devices and advances are being made all the time. One problem facing the tidal energy sector is grid connection. Many of the areas that are most suitable for large scale tidal energy production are isolated areas well away from existing grid infrastructure and the cost of supplying grid connection to these areas often makes the project unviable. Couple this with the large costs of device development and deployment, the time scale for return on investment and the risks involved in new technology. These problems often result in finance being difficult to obtain for these projects (Hardisty 2009).

This project hopes to examine the viability of small scale tidal energy projects (< 20KW) where the energy produced would be used locally therefore negating some of the problems associated with larger scale tidal projects. In order to assess the suitability of areas for these types of projects there is a need for tidal data to be collected and analysed. Because of the scale of these projects it is important that the gathering of this data can be carried out on a cost effective basis. It is with this in mind that a review of current methods of open channel flow measurements be undertaken and a possible low cost alternative method or device be developed.

## **2. Open channel flow measurement methods and technologies.**

Flow rates in open channels are inherently hard to measure due to non uniform dimensions and variations in channel widths and depths along the length of the channel. This will result in varying flow rate velocities across the channel. Flow velocities also vary with depth due to drag caused by channel sides and bottoms. In order to establish flow rates it is usually required that the flow velocity is first established. As mentioned, measuring flow rates in an open channel is difficult but this is largely due to the difficulty in measuring the flow velocity in the channel. A number of methods have been developed for open channel flow measurement over the years and the method chosen would depend on the channel dimensions, cross sectional shape and accessibility

## **2.1. Weirs.**

One of the most accurate and simplest ways of measuring flow in an open channel is to divert the flow through a weir which is a structure of known dimensions. This permits flow rates to be measured as a function of depth of flow through the structure. A simple weir consists of a bulkhead constructed from metal, concrete or timber with an opening cut into its top edge which is of known dimensions. The height of water in the weir is then measured at a given distance upstream of the weir and the flow velocity can therefore be calculated. A number of flow rate measuring devices are designed to be used in conjunction with weirs and are useful for determining discharges from streams and outfalls. These devices can be mechanical, electronic or ultrasonic. By using these devices to determine the fluid level in the weir pond, the flow rate can then be determined. The specifications of the weir pond is often incorporated or programmed into the device to give an instantaneous flow rate reading (Crowe et al 2005).

## **2.2. Flow rate measurements using tracers.**

Salt or dye can be used for flow rate measurements and both offer equally accurate results with the only difference being the equipment required to monitor the dissolution of the chosen substance.

### **2.2.1. Colour velocity measurements.**

Dyes have the advantage of being easily detected visually but this affords much less accuracy. For greater accuracy when using dye, fluorometer detection equipment or a set of visual colour comparison standards must be used. The dye is injected upstream and the water is sampled downstream. The degree to which the dye has been dissolved will depend on the amount of water that the dye has mixed with and is therefore a function of the flow rate. Multiple injection points and sampling at two stations downstream from the injection points produces very high accuracy. Visual detection is more suitable for pipe work and involves the addition of dye at one end of the pipe and then timing the first appearance of dye at the other end of the pipe and also the time taken for the dye to disappear. The mean flow velocity can then be worked out and the discharge rate can also be calculated using the cross sectional area of the pipe. This system can also be used in open channel but it has limitations. In fast moving flows, near surface aeration and sprays can make the detection of the dye difficult and in slow running flows there may be problems with mixing

### **2.2.2. Salt velocity measurements.**

Salt velocity measurements are conducted in much the same way as colour velocity measurements. In this case however high concentrations of sodium chloride (NaCl) are injected into the flow to be measured. Higher concentrations of salt increased the electrical conductivity of the water. Pairs of electrode placed downstream record the conductivity of the water as it passes. A series of these electrode pairs can be used to determine how long it will take for the section of water that had the salt injected into it, to reach the different points where the electrodes are situated. Again this method is

more suitable for measuring flows in pipe work but it is also often employed in the measurement of open channel flow velocities.

### **2.3. Anemometer and propeller current meters.**

Anemometer and propeller current meters are quite common and are useful in many situations. They consist of a propeller which rotates on a shaft when placed in a current and each revolution of the propeller produces a pulse or a number of pulses. The faster the propeller turns, the more pulses are produced. The speed at which these pulses are produced determines the speed of the flow the instrument is placed in. Anemometer current meters work on the same principle but they employ anemometer cups in place of a propeller. These instruments are directional and must face into the oncoming flow in order to work. This is achieved by deploying them on a rod that is positioned and fixed so that the instrument faces the flow or they can also be deployed by suspending them on a rope or wire. The addition of a tail fin to the instrument housing will cause it to turn into the predominant oncoming flow. As this type of instrument does not sense the directional flow, eddies and backflows may not be detected. It is important to choose the correct instrument for the required task and some propeller current meters have interchangeable propellers for different flow velocities and resolutions (Web United States Department of the Interior Bureau of Reclamation Web Site, 2001)

### **2.4. Deflection meters.**

A deflection meter consists of a shaped vane that is placed into the flowing water. The velocity of the flowing water exerts a force on this vane and a secondary device such as a load cell measures the deflection of the vane. The vanes can be shaped to match the flow section geometry to make them deflect the same amount for any given discharge regardless of the depth of flow in the flow section. This however suggests that a presumption is made that the flow is uniform throughout the water column that is being measured. In open channel tidal basins this will probably not be the case. Deflection meters can be permanently mounted to a structure or may be moved from one location to another but the instrument will need to be solidly fixed to some immovable object in order that the vane deflects and that there is not movement in the whole instrument which would affect the accuracy of the deflection meter.

### **2.5. Pitot tubes.**

Pitot tubes consist of a simple tube pointing directly into the fluid flow. The flow of fluid entering the tube results in a pressure build up within the tube. The tube has no outlet and therefore the fluid comes to rest within the tube. This pressure can then be measured is a function of the velocity of the fluid acting on the inlet of the tube. Pitot tubes are difficult to use in channels with slow flows as the pressure differential are very small and hard to measure. Depending on the accuracy required, the secondary equipment needed to measure the pressure differential could be expensive and difficult to implement.

## **2.6 Ultrasonic and acoustic flowmeters.**

Ultrasonic are employed in a number of different ways in order to measure river and tidal flows. The choice of measuring device will depend on the exact application and the budget available.

### **2.6.1 Doppler type acoustic meters.**

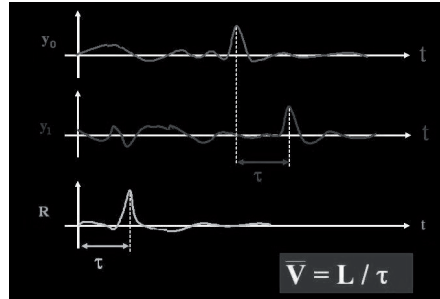
Doppler type acoustic meters consist of an ultrasonic transmitter and a receiver usually incorporated in a single head. Signals are transmitted at a known frequency and these signals reflect off suspended solids in the fluid. The receiver then picks up this reflection and the frequency shift of the received signal from that of the transmitted signal is related to the mean velocity of the fluid. Because the operation of the instrument is based on the Doppler effect, the frequency will increase or decrease depending on if the particles are moving toward or away from instrument and the speed at which the particles moving. This instrument is therefore non directional and is very effective.

### **2.6.2 Transit-Time Flow Meters.**

Transit time ultrasonic flow meters are based on the principle that the transit time of acoustics signals along a known path is altered by the fluid velocity. An ultrasonic signal sent upstream travels slower than a signal sent downstream. By transmitting an ultrasonic signal in both directions along a diagonal path, the average path velocity can be measured and the average flow velocity can be therefore determined. This is a very effective method for measuring flow in conduits, wastewater and water treatment plants and volumetric metering but may not be suitable for large open channels and would not be suitable for measuring tidal flows in open water.

### **2.6.3 Cross-Correlation Ultrasonic Meters.**

A cross correlation meter consists of two ultrasonic transmitters and receivers. The transmitters and receivers are arranged in two pairs with a small distance between them. The instrument works by transmitting an acoustic signal at high frequency which reflects back to the paired receiver from suspended solids in the water. The second transmitter also transmits an identical signal which is reflected back to its paired receiver. The profile of the signals received by both receivers is compared and when a signal at the second receiver is the same as a signal previously received by the first, then the same column of water has passed beneath both receivers. Because of the known distance between two receivers, it is possible to determine the time taken for the water column to travel from one point to another and therefore the flow velocity can be determined (Baker, 2000).



**Figure 3: Principle of operation of the cross correlation ultrasonic transducer where  $L$  = the distance between the transmitter-receiver pairs and  $\tau$  = transit time.** (Web Shenitech Web Site)

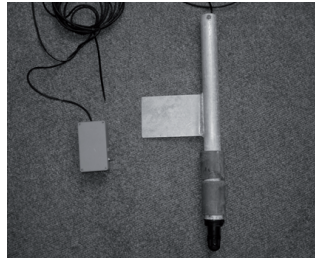
## 2.7 Measurement by float.

This is a method of flow velocity measurement as against an instrument for flow velocity measurement. Firstly the depth of the channel where the flow measurement is taking place needs to be determined at various intervals. A float is placed in river at a place where it is straight and uniform in cross section and grade with a minimum of surface waves. Under the best of conditions, the floats are often diverted from the most direct course between the measuring points so this measuring operation should never be carried out on windy days. The floats are then allowed to travel between the measuring points and the time taken is recorded. Oranges are often used as floats because they are buoyant and are easy to see. The procedure should be carried out a number of times and an average time established. The time taken is then multiplied by a coefficient which is determined by the average depth of the water and the type of river bed terrain. This system gives a reasonable approximation of the flow velocity.

## 2.8 Hall effect paddle wheel measuring device.

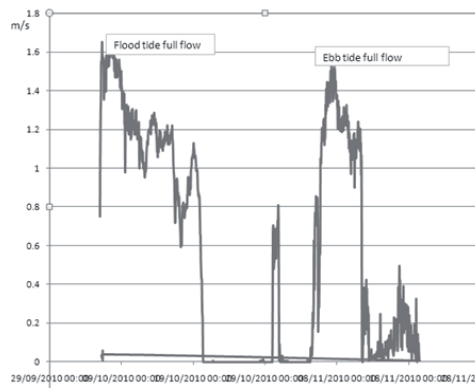
This is an instrument which has been developed for the purpose of this project which necessitates the recording of flow velocities in open channels and open seas for the purpose of determining the potential energy available in tidal flows in particular areas. Due to budget constraints, a low cost instrument was required and therefore off the shelf marine electronics were used to fabricate the instrument. An ST300 transducer manufactured by Airmar which consists of a paddle wheel which turns when placed in moving stream of water. As the paddle wheel turns, it emits a pulse and the frequency of these pulses determines the speed of the paddle wheel and therefore the velocity of the stream of water. A device was fabricated to hold the transducer so it could be deployed and as the transducer is directional, a fin was added to the device so that it would face into the flow of water at all times. The transducer was connected to an Omega data logger which records the frequency of the pulses and stores the information. The information can be collected over a period of hours to weeks and can then be downloaded to a computer.





**Figure 4: Paddle transducer and deployment device.**

This device was deployed for testing in an area known as The Crompan, near Youghal in East Cork. The device was suspended from a bridge where the tide flows into an estuary. While there was no method for determining the accuracy of the readings obtained, if the transducer was deployed properly into the flow, the pulse frequency should be a function of the flow. Initial results were encouraging in that the maximum flows recorded correlated with the times when maximum flows would be expected. That is three hours after full tide and three hours after low tide. However at flows of less than 0.8 m/s there was no information recorded.



**Figure 5: Recorded data from Crompan Bridge Youghal**

### 3. Conclusions and future plans

Due to the need to record data in large tidal estuaries and open areas of sea the measuring methods and devices were assessed for suitability for the required task. It was decided that a cross correlation ultrasonic transducer would be best suited and the reasons for this decision are set out below.

While weirs work well for irrigation systems and small river networks, there is no possibility of using this method for assessing flows in large tidal estuaries and channels.

Using tracers such as salt or dye would not be suitable either for large areas where the diffusion of the trace material would be too hard to monitor or else huge amounts of the tracers would be required which would not be practical for the envisaged task.

A deflection meter would need to be mounted securely to an object or structure in order for the deflection of the vane immersed in the water to be measured. This would be difficult to implement successfully and would certainly affect the portability of the device.

While the pitot tube is a very effective instrument for monitoring flow velocities in conduits, they are very difficult to implement for open channel measurements and the equipment necessary to detect and measure the small pressure differences would also be difficult to set up and could be quite expensive.

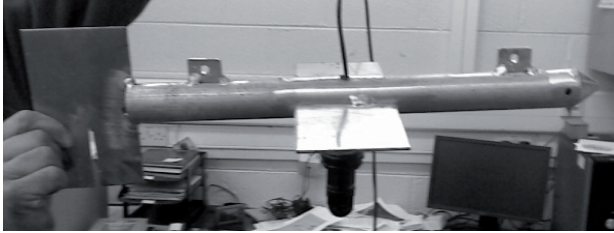
Transit time flow meters are also very effective for measuring flow velocities in pipes and conduits but because of the set up required to send and receive the signals, it would also be very difficult to set up in a tidal channel and would not work in more open waters.

Float measurements is probably one of the simplest methods of flow velocity measurements but would require a quite a bit of preparatory work to assess the average depth of the channel to be measured. This method would also need to be carried out a number of times in order to obtain a good average. It may not be easy to get the weather conditions necessary for this method very often especially in winter months on open water. It is not possible to determine flow velocities at different depths using this method.

The instrument that is most suitable for tidal flow velocity measurements is the acoustic Doppler current profiler as this instrument is designed specifically for assessing tidal or run of river flow velocities. However these instruments are very expensive to purchase or even to hire and are beyond the means of this project.

The instrument fabricated with the use of the Airmar ST300 paddlewheel transducer is promising but the resolution would need to be better so that lower flows than previous could be recorded. The deployment device has been redesigned in order to minimise deflection by the tidal stream and therefore enable the transducer to be presented at a more optimum angle to the water flow so that turbulence may be reduced and to allow the full flow of the water to impact the transducer.

It was decided that a cross correlation ultrasonic transducer would be best suited for the project requirements as the resolution would be much better than the paddle wheel transducer and much lower flows could be detected. Another transducer manufactured by Airmar, the CS4500 has been identified as being suitable as its output is the same as the ST300 already being used which will allow the existing data logger and software to be used and it can be deployed in the same manner as the ST300. The CS4500 can detect flows of 0.05m/s and can operate within 50cm of the sea bed without ultrasonic reflections affecting the results. Figure 6 below shows the new device that has been designed and fabricated to deploy the transducer more effectively and with minimum deflection.



**Figure 6: New device for transducer deployment.**

When the ultrasonic transducer has been fitted to the new device and initial tests carried out to determine its response to a variation of flows, it is hoped to deploy the device in conjunction with an Acoustic Doppler Current Profiler operated by the Marine Institute in Galway in order to corroborate its readings. It is then hoped to use the instrument to investigate the differing flow velocities within a tidal channel at depth varies and to therefore establish the optimum depth for tidal power extraction.

#### **4 References**

Web Eirgrid Web Site (2011) <http://www.eirgrid.com/operations/systemperformancedata/windgeneration/>. (Accessed 4 January 2011)

Hardisty J. (2009), *The Analysis of tidal Stream Power*, Wiley & Blackwell, ISBN 978-0-470-72451-4.

Crowe C., Elger D., Robertson J. (2005), *Engineering Fluid Mechanics*, Eight Edition, John Wiley & Sons, ISBN 0-471-48737-6

Web United States Department of the Interior Bureau of Reclamation Web Site (2001), [http://www.usbr.gov/pmts/hydraulics\\_lab/pubs/wmm/](http://www.usbr.gov/pmts/hydraulics_lab/pubs/wmm/) (Accessed 3 January 2011).

Web Shenitech Web Site, <http://www.shenitech.com/flowmeas.htm> (Accessed 3 January 2011)

Baker R. (2000), *Flow Measurement Handbook*, Cambridge University Press, ISBN 0-521-48010-8



# Requirements Gathering for a Bioinformatics Workflow Tool

J. Carroll <sup>1,3</sup>, P. Walsh <sup>1,3</sup>, P Rothwell <sup>1,3</sup> and R. D. Sleator <sup>1,3</sup>

1 Department of Computing,  
Cork Institute of Technology, Rossa Avenue,  
Bishopstown, Cork, Ireland

2 Department of Biological Sciences,  
Cork Institute of Technology, Rossa Avenue,  
Bishopstown, Cork, Ireland

3 CIT Bioinformatics Group,  
Cork Institute of Technology, Rossa Avenue,  
Bishopstown, Cork, Ireland

E-mail: [jtcarroll@gmail.com](mailto:jtcarroll@gmail.com), [paul.walsh@cit.ie](mailto:paul.walsh@cit.ie), [roy.sleator@cit.ie](mailto:roy.sleator@cit.ie) and  
[paul.rothwell@cit.ie](mailto:paul.rothwell@cit.ie)

## Abstract

Knowledge of bioinformatics is now a core skill for biologists who nowadays spend part of their time at the bench and part of their time at a computer. Bioinformatics is a way to quickly test hypotheses without the need for performing wet-lab experiments. There are many web and desktop tools available for a biologist to complete bioinformatics tasks, that may require users to manually and repeatedly co-ordinate multiple tools to produce the required data. As a result many workflow tools have been developed to automate these tasks using web services. Many of these tools are tailored for specialist bioinformaticians or are unstable and may require too much time to learn; as a consequence, many biologists fail to engage with these workflow tools.

This paper presents an overview of the findings collected from molecular/micro biologists and bioinformaticians about what features they would like to see in a new bioinformatics workflow tool. The requirements were gathered using interviews, focus groups and an internet based survey. The requirements gathered were then used to evaluate three web based bioinformatics workflow tools currently available.

## Keywords

Bioinformatic workflow tools, Usability, Requirements gathering, Web services, Bioinformatics and Rich Internet Application

## 1. Introduction

Bioinformatics is often defined as the application of computational techniques to understand and organize the information associated with DNA/protein molecules (Luscombe et al., 2001). Bioinformatics encompasses a wide range of subject areas from structural biology, genomics, gene expression studies, drug discovery, computing and statistics. The Bioinformatics Links Directory (Brazas et al., 2009) has close to 3,000 unique links to bioinformatics tools and databases; a number that continues to increase with each annual publication of the list. The main bioinformatics centres are the National Centre for Biotechnology Information (NCBI), European Bioinformatics Institute (EBI) and DNA Databank of Japan (DDBJ). While these centres are the primary source of publically available databases, tools and web services, many third parties have also developed tools to allow researchers to access these databases and also execute remote tasks over the internet.

The last decade has seen a significant uptake of next generation sequencing and other high throughput technologies that has led to an enormous increase in the amount of biological data held in publically available databases (Brooksbank et al., 2009). The aim of bioinformatics is to manage and analyze the data; allowing researchers to develop tools to facilitate analysis, create new knowledge and to interpret results in a meaningful manner (Luscomb et al, 2001). The last decade has also seen bioinformatics move from being a distinct discipline to becoming an integral component of mainstream biology. As the volume of biological data increased the need for researchers is also increasing, resulting in the uptake of undergraduate bioinformatics courses and modules in bioscience undergraduate courses (Hack and Kendall, 2005). These courses are primarily aimed at teaching graduates bioinformatics techniques and tools to learn new biology and knowledge about living systems from the biological data. Bioinformaticians have expertise in computer science, biology and may also have knowledge of mathematics and statistics. A bioinformatics task can sometimes require biologists to manually and repeatedly co-ordinate multiple tools to produce a result (Hull et al., 2006). An example of such a task would be to use three different bioinformatics tools in succession to produce the required data, as each tool has completed and returns data, the biologist must manually clean and format the data to ensure compatibility with the next tool. This is time consuming, error prone and hard to retrace, a reason why many bioinformatics workflow tools have been developed (Tiwari and Sekhar, 2007, Hull et al., 2006).

## 2. Bioinformatics workflow tools

Workflow tools have become popular in science over the last two decades (Deelman et al., 2009). These tools provide a graphical user interface (GUI) allowing a researcher to visually build a workflow by selecting several components, each of which performs a task in the workflow. In most workflow tools the researcher does not need to write any code or have in-depth knowledge of computer systems to build a workflow. Once a workflow has been created it can be reused again and again.

Complex and powerful workflows can be created saving the researcher both time and effort, allowing them to focus on the specific research question rather than the tool i.e. micromanaging bioinformatics tasks. There are many bioinformatics workflow tools available online or as desktop applications. Some workflow tools are aimed at bioinformaticians where background knowledge in computing and the concept of invoking web services must be understood, other workflow tools target biologists who have little or no computing background. Early bioinformatics workflow tools were developed for specialist bioinformaticians and based on Unix platform using command line software (Kumar and Dudley, 2007); while this approach remains popular today, for pure biologists venturing into the bioinformatics arena it is a very difficult transition and requires a significant time investment for biologists to learn how to write scripts and then patch the scripts together to create a workflow. Web services (Booth et al., 2004) have become popular as they allow interoperable machine-to-machine communication using existing internet standards such as HTTP (The Hypertext Transfer Protocol), XML (Extensible Markup Language), SOAP (Simple Object Access Protocol) and WSDL (Web Services Description Language). In recent years more providers are turning to RESTful web services, these are “lighter weight” than a SOAP web service (Bensilmane et al., 2008). Many bioinformatics workflow tools have been developed using web services allowing users to build workflows and use remote computers to search and analyze data.

Desktop applications	Web based tools
Taverna- <a href="http://www.Taverna.org.uk">http://www.Taverna.org.uk</a>	WebLab- <a href="http://weblab.cbi.pku.edu.cn">http://weblab.cbi.pku.edu.cn</a>
Ugene- <a href="http://ugene.unipro.ru">http://ugene.unipro.ru</a>	Bioextract- <a href="http://bioextract.org">http://bioextract.org</a>
Wildfire- <a href="http://wildfire.bii.a-star.edu.sg/index.php">http://wildfire.bii.a-star.edu.sg/index.php</a>	Galaxy- <a href="http://galaxy.psu.edu/">http://galaxy.psu.edu/</a>
Triana- <a href="http://www.trianacode.org/">http://www.trianacode.org/</a>	Biobike- <a href="http://www.biobike.org">http://www.biobike.org</a>

**Figure 1: Popular bioinformatics workflow tools (all open source)**

The bioinformatics workflow tools currently available (see Figure 1) are desktop applications that use local resources and web services for workflow execution in the application. There are also web based workflow tools built using Web 2.0 technologies (Knights M., 2007), in this case the workflow execution is performed on a server while a browser is used to create workflows and to review workflow results. There were no known RIA (rich internet application) bioinformatics workflow tools currently available, Microsoft’s general workflow tool called Popfly has been discontinued and Calvin (Held et al, 2009) demo page was not available from the developers web site. Rich internet applications are embedded in an internet browser and have similar behavior to desktop applications enabling sophisticated user interactions, client-side processing, asynchronous communications, and multimedia (Fraternali et al, 2010).

### 3. Usability of bioinformatics tools

In the development of software it is important to conduct usability analysis to detect, understand, mitigate and prevent usability problems. Usability problems can pose significant obstacles to a satisfactory user experience and force researchers to spend unnecessary time and effort to complete their tasks (Bolchini et al., 2008). The International Organization for Standards (ISO) defines usability in ISO(9241 Part 11) as *“the extent to which a product can be used by specified users to achieve specified goals with effectiveness, efficiency and satisfaction in a specified context of use”*. Ideally, to make software usable, development of interactive software should be user centered and developers should use an iterative development process where repeat evaluation and redesign cycles are carried out throughout the application life cycle, from gathering requirements to deployment of the application (Greene et al., 2003). The adoption of bioinformatics into main stream biology has seen an increase in the number of tools being developed and maintained by universities, institutes and commercial companies but the acceptance and use of these tools by biologist’s lags behind the tool proliferation (Shachak et al, 2007). The majority of bioinformatics workflow tools are open source (<http://www.opensource.org>) projects. The term ‘open source’ has become somewhat of a buzzword in bioinformatics of late, indeed, freely available software has been a cornerstone of collaborative science for a long time (Stajich et al., 2006), yet despite its success, open source faces a number of fundamental challenges; the most severe of which is the lack of usability for non-technical users compared to commercial software. The role of user-centered approaches and usability engineering has been largely neglected in research on open source software development, heuristic evaluation is the inspection method most used. A study by Andreasen et al., 2006, to discover open source developer’s opinions and practices in usability, noted that the majority of developers thought usability was either of a ‘high’ importance or ‘very high’ importance. The conclusion in the study was *“Overall we found that open source software developers are interested in usability, but in practice most of the efforts are based on common sense. They appreciate external usability evaluations performed by professionals, as long as these professionals are not interfering in decision-making about changes and priorities.”*

### 4. Requirements gathering

Requirements gathering or requirements elicitation is concerned with trying to discover what users really need in software. Data was collected using various qualitative and quantitative research methods, this data will be used in the development of a prototype bioinformatics workflow tool called BioMapper. In user centered design it is important to understand who the target users are, the kind of tasks these users wish to perform with the software and also what environment will the software be used in (Kirakowski and Cierlik, 1999). To understand what tasks users perform in bioinformatics and also what tools they use to perform these tasks, interviews and focus groups were undertaken. An online survey was also conducted to get feedback from the bioinformatics community.

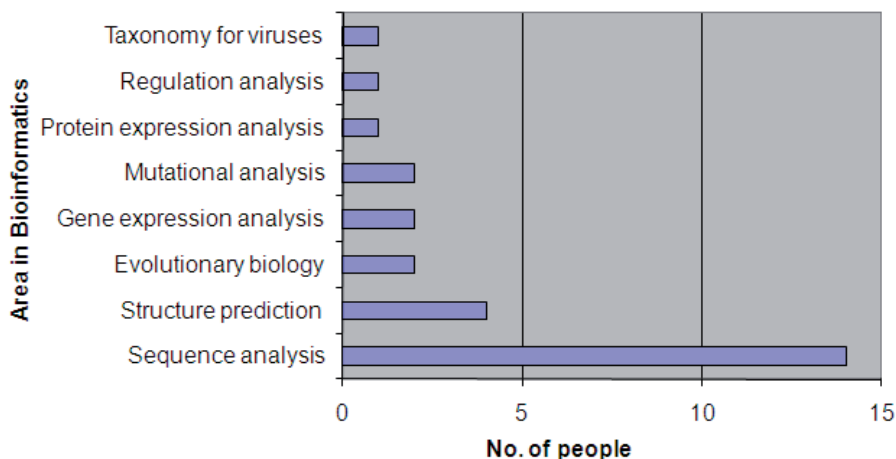


#### 4.1 Users and environment

Researchers in the Biological Sciences Department of Cork Institute of Technology were asked questions about their studies, age, general computer experience, bioinformatics training and attitude towards bioinformatics. Eight researchers were individually asked questions. The researchers taking part in the requirements gathering were typically: micro or molecular biologists, mid twenties to early thirties in age, have no abnormal physical characteristics (e.g. not colour blind), have a degree, masters or PhD, have a working knowledge of Microsoft Windows and Microsoft Office and would regard themselves as having little to adequate experience in bioinformatics. The researchers had no formal training in using bioinformatics tools; it was picked up from other biologists or learned by doing tutorials about tool use. Some comments people had were “easy to get frustrated, you need patience”, “repetitive work”, “don’t mind using programs once they save time” and “would rather do wetlab work”. Nearly all the researchers would like to learn more about bioinformatics as its “getting big” in biology. The environment in which bioinformatics is performed by the researchers is in a dedicated bioinformatics lab with several high power desktops.

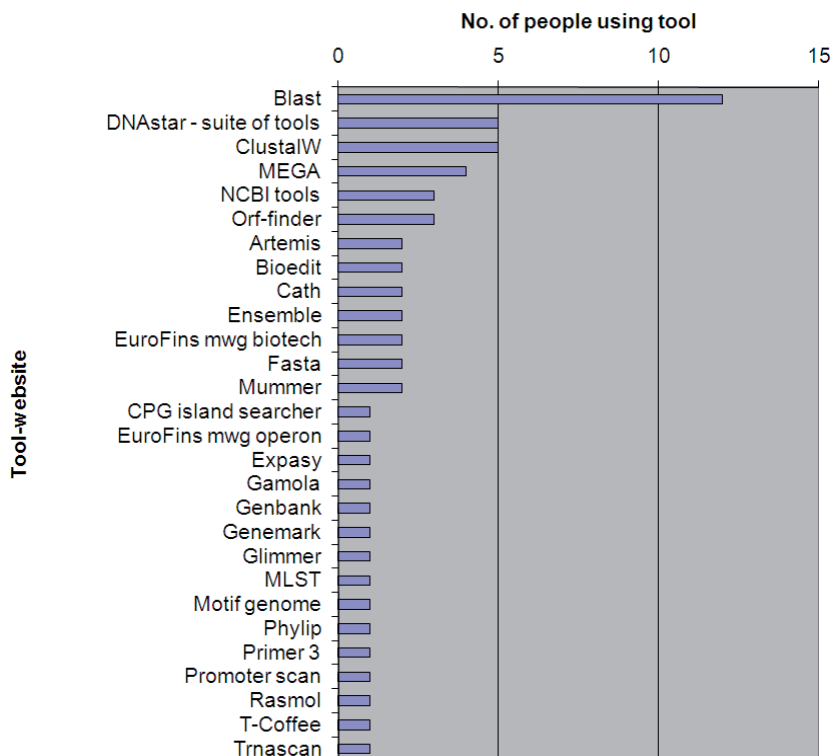
#### 4.2 Informal interviews

The interviews were conducted to discover what bioinformatics tools were being used, the bioinformatics area of use and also any comments the user had about the tools. The interviews (Christel and Kang, 1992) were one to one, structured and had twelve questions; both open ended and closed questions. The interview time varied from five minutes to thirty minutes depending on the respondents experience with bioinformatics tools. There were sixteen interviews held at Cork Institute of Technology in the Biological Sciences Department and one interview with a PhD candidate in University College Cork doing research in the area of Metagenomics (Sleator et al, 2008). Researchers in general described bioinformatics as “sequence analysis”, “the coming together of computers and biology” and “using software to investigate DNA sequences”. Two researchers have no bioinformatics experience, four people have done basic bioinformatics e.g. used BLAST (Johnson et al, 2008) but eleven researchers have used many tools and spent some time doing bioinformatics. One common complaint about bioinformatics software was the lack of security or poor tutorials and documentation. Nobody had used any bioinformatics workflow software.



**Figure 2: The bioinformatic research areas people have worked in**

Figure 2 shows that sequence analysis is the most common area of research. Figure 6 also indicates that sequence analysis is a core task in bioinformatics, a new workflow tool most satisfy users in this area if it is to be successful. Sequence analysis is often a starting point in research before advancing to more specialized areas such as regulation analysis.



**Figure 3: The bioinformatics tools used by people in their research**

Figure 3 shows tools people have used in their bioinformatic research. The most used tools such as Blast and ClustalW are used in sequence analysis. Some tools perform the same task but may use different algorithms to generate a result e.g. Orfinder, Genemark and Glimmer are all gene prediction tools. The tools listed perform tasks such as similarity searches, multiple sequence alignments, phylogenetic analysis and gene prediction, any new bioinformatics workflow tool must include these common tools.

### 4.3 Focus groups

Two focus groups were held to get the group's feelings, attitude and ideas on bioinformatics in general and the tools they have used in their research. "*Focus groups are group discussions organized to explore a specific set of issues such as people views and experience in a particular topic*" (Kitinger, 1994). Focus groups are widely used in marketing but can be used in any area where information is needed about people's experiences, thoughts and attitude on a topic.

The first focus group was comprised of biological sciences master's candidate's and PhD candidates who were in their second last or final year of masters/PhD. All participants had used several bioinformatics tools and techniques in their research projects, this group was called the 'expert group'. This group was comprised of a moderator, facilitator and six researchers from the biological sciences department and one person from the computing department. The second focus group had participants who were in their first or second year of masters/PhD and some have started using bioinformatics tools for research projects, the group was supported by a moderator and facilitator. The facilitator sometimes rephrased questions put to the group, both groups had a language barrier (DeMarco, 1980) problem between the computing moderator and the biological science participants.

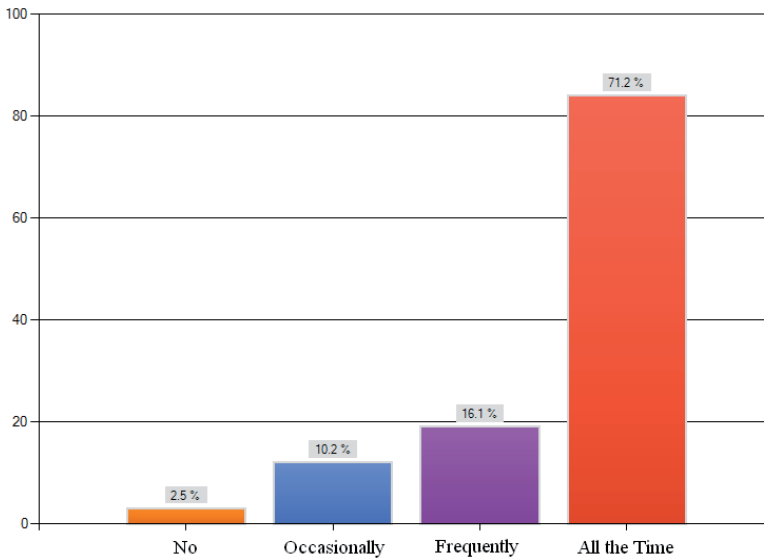
The findings from the two focus groups are:

- While nearly all had used BLAST nobody really understood the advanced settings, most use the default settings. The group agreed that a feature that reduced the complexity of the BLAST tool would be helpful, an example is giving the user 3 options in BLAST such as minimum, medium or maximum settings. These 3 levels would change the level of comparison when doing a similarity search on a gene or protein. Minimum being a loose comparison and maximum being a strict comparison. Choosing an option would change the required advanced settings for a BLAST request.
- In general the group found a lot of tools difficult to use; tools are usually built for experts making the transition difficult for those who are new to bioinformatics especially given that the documentation or tutorials are often poor or written in a language that exists outside of their own lexicon. These problems resulted in the researchers not using a tool.
- Most people find out about what the tools they need to use from other more experienced researchers in the department or research papers online. A lot of information is passed on from someone else who learned to use the tool. The researchers did not have any formal training in bioinformatics so they only used tools needed to complete their research.

- Use the least number of tools as possible, some people use 4-5 tools in a row to get the data needed.
- Some tools return too much information making it difficult to extract the relevant information. The researchers would like the results to be highlighted in some way or a report generated with only the relevant results.
- When using several tools in series to get a result, the output from some tools must be cleaned or formatted in order to suit the input for the next tool, there was also too much 'copy and paste' between tools. Doing this work manually takes time; a workflow tool that automatically did much of the tedious work would be useful. One important point raised was that a workflow tool should be able to show the tools and settings used to obtain the results, being able to run the same workflow with the same settings again and again, i.e. traceability is very important. Biologists want to see inputs and results for each task in a workflow, many tools only return the output for the last workflow task. The researchers would like to be able to save created workflows.
- A web based application would be preferred as it would allow the researcher to use it anywhere.
- Many people spoke of information overload, a tool that helped manage results would be useful.
- The group agreed that bioinformatics is a means to an end to get results; it is another technique to use. They don't really care about bioinformatics; they are biologists (molecular & micro).
- All the researchers will be using bioinformatics tools in their research projects, some more than others. Researchers could see that knowledge of bioinformatics will be important in their career.

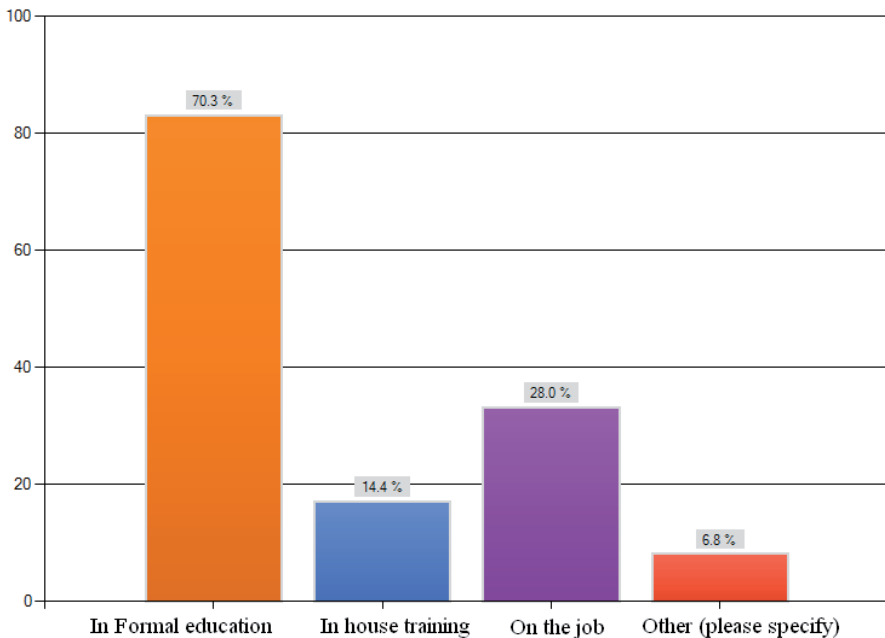
#### 4.4 Online survey

The survey was hosted by [www.surveymonkey.com](http://www.surveymonkey.com) and was taken by 119 people from the 9th February, 2010 to 9th July, 2010. The online survey questions are based on the interviews with researchers in the Cork Institute of Technology Biological Sciences Department. Links to the survey were posted in several bioinformatics forums and groups, members of the groups are required to be registered before accessing forum content.



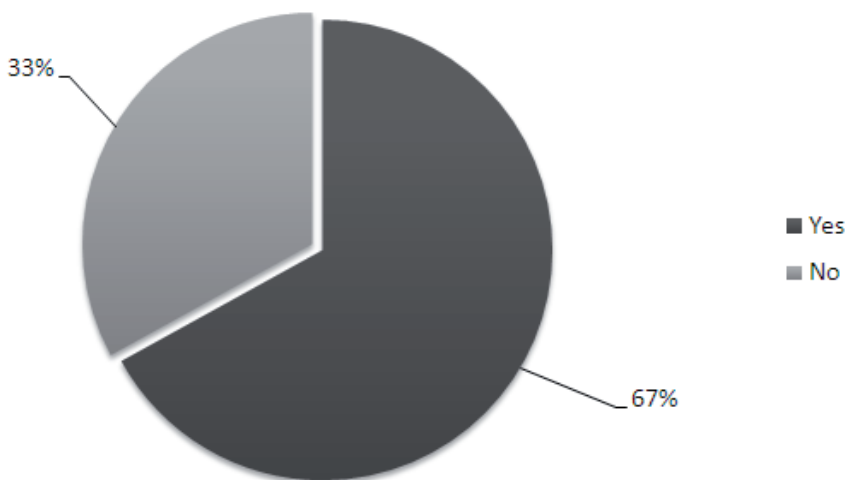
**Figure 4: Do people work in bioinformatics all the time**

Figure 4 shows how much time people spend doing bioinformatics. The survey indicates that it was taken by both bioinformaticians who spend all their time doing bioinformatics and biologists who spend only part of their time doing bioinformatics.



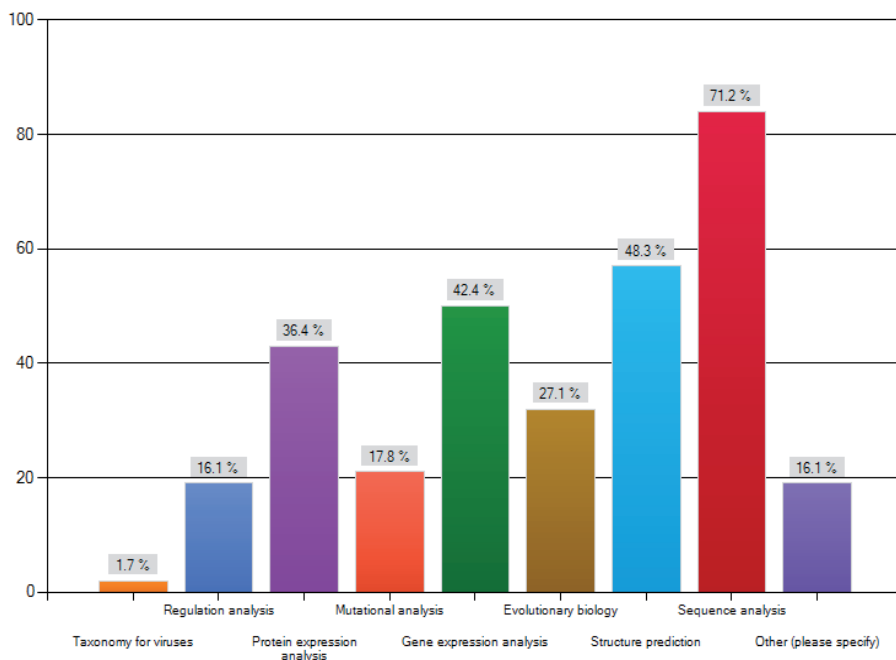
**Figure 5: Where did people receive their training**

Figure 5 shows where people received their bioinformatics training. A few people commented that they were thought by attending workshops and online courses.



**Figure 6: People who have used bioinformatics workflow tools**

In figure 6 there were also 14 respondents who added comments about the tools used. 4 people used Taverna, 2 people used Galaxy and 1 person used Ugene. There were 7 other respondents who used workflow tools, but these tools were for data mining and report generation.



**Figure 7: The areas of bioinformatics people have worked in**

Figure 7 shows the area of bioinformatics people have worked in. The survey is similar to the interviews; sequence analysis and structure prediction are the most common bioinformatics tasks. The survey shows that evolutionary biology, gene expression analysis and protein expression analysis are more widely used tasks in the bioinformatics community than people who took the interview in Cork Institute of Technology, tools for these areas must be included in a new bioinformatics workflow tool. Other areas of research were drug design, biochemical pathway analysis, metabolomics, microRNA validation and microRNA prediction.

#### 4.5 Competitive analysis of three web based bioinformatics workflow tools

A competitive analysis was completed to identify the strengths and weaknesses of competing products before starting work on prototype tool. Each website was examined by following simple tutorials on how to create a workflow and rated about how the workflow was created, difficulty in creating workflow, how results are stored, if there is security and many other questions were answered as the tool was used. The three web based bioinformatics workflow tools currently examined are Galaxy (Giardine B. et al, 2005), Weblab (Liu X. et al, 2009) and BioExtract (Lushbough C. et al, 2010). The tools investigated in Table 1 were selected for investigation as the focus groups found biologists want to use a web based bioinformatics workflow tool, these tools were developed for both biologists and bioinformaticians.

The three web based tools are aimed at bioinformaticians and computational biologists, the developers of each tool published a paper and went into depth about the technical challenges and architecture of the systems but none of the papers mention anything about any requirements gathering or usability testing being undertaken. Two tools did have data storage facilities for results and workflows but for each tool it took some time to figure out how to save and retrieve stored information.

Feature examined	Galaxy	BioExtract	WebLab
How pleasant is the tool to use (satisfaction)?	Tools menu is confusing	Easy to use	Easy to use
Can workflows be shared with other users?	yes	yes	yes
Are workflow results stored online?	yes	no	yes
Can results be shared with other users?	yes	yes	yes
Are there advanced settings for each task e.g. change matrix or gap costs?	yes	yes	yes
Is there traceability between tasks (data provenance)?	yes	yes	no
Is there data encryption over the internet (https)?	no	no	no
Can a user add a web service to the tool?	no	yes	no
How stable is the tool?	Browser sometimes stopped working	stable	stable
Is there documentation on tool use?	no	yes	yes
Are there tutorials or videos on how to use tool?	yes	yes	yes
Is there online support e.g. forum, wiki?	no	no	no
How easy is it to accomplish a basic task on first use (learnability)?	Confusing, video tutorials were viewed	Easy	Easy

**Table 1: A table showing features examined in each tool**

## 5. Conclusions and the future

There are many bioinformatics workflow tools available to use, but not all are user friendly and all lack one or more features such as traceability, security and data management. The information gathered indicates that biologists are willing to use a bioinformatics workflow tool but it must be easy to use, require little or no training



and present results in a way that users can quickly review important information by highlighting relevant text, and using graphs or charts where possible.

The CIT Bioinformatics Group is currently developing a prototype bioinformatics workflow tool to meet the biologists requirements indicated in this paper. The project has put early and continual focus on users and their tasks. Biologists are involved and contributing valuable feedback through task oriented usability inspection methods such as cognitive walkthroughs (Wharton et al, 1994) on the prototype tool, the feedback from biologists will drive the development of the project. The project is nearing a stage where an early version of the bioinformatics tool will be made available online but with limited functionality.

## 6. Acknowledgements

The Faculty of Engineering and Science for providing the funding necessary to undertake the project.

## 7. References

- Andreasen M., Nielsen H., Schroder S. and Stage J. (2006), "Usability in open source software development: opinions and practice", *Information Technology and Control*, 2006, Volume 35A, Number 3, ISSN 1392 – 124X
- Bensilmane D., Dustdar S. and Sheth A. (2008), "Services Mashups - The New Generation of Web Applications Services Mashups", *IEEE Computer Society*, 1089-7801/08, September/October 2008.
- Bolchini D., Finkelstein A., Perrone V. and Nagl S. (2008), "Better bioinformatics through usability analysis", *Bioinformatics*, Volume 25, number 3, 2009, pp. 406-412.
- Booth, D., Haas, H., McCabe, F., Newcomer E., Champion M., Ferris C. and Orchard D. (2004), "Web services architecture. W3C Working Group Note", *W3C website* <http://www.w3.org/TR/ws-arch>.
- Brazas M.D., Yamada J.T. and Ouellette B.F. (2009), "Evolution in bioinformatic resources: 2009 update on the Bioinformatics Links Directory", *Nucleic Acids Research*. (2009) 37:W3–W5.
- Brooksbank C., Cameron G. and Thornton J. (2009), "The European Bioinformatics Institute's data resources", *Nucleic Acids Research*, Advance Access, 10.1093/nar/gkp986.
- Christel. M.G. and Kang K.C. (1992), "Issues in requirements elicitation", Carnegie Mellon University, *Technical Report CMU/SEI-92-TR-12*, September 1992.
- Deelman.E., Gannon.D., Shields.M. and Taylor.I. (2009), "Workflows and e-Science: An overview of workflow system features and capabilities", *Future Generation Computer Systems*, Volume 25, Issue 5, pp. 528-540.
- DeMarco T. (1980), "Breaking the language barrier", *ACM SIGMETRICS Performance Evaluation Review*, Volume 9, Issue 1, pp. 41 – 45.

Fraternali P., Di Milano P., Rossi G. and Fernando S.F. (2010), “Rich Internet Applications”, *IEEE Computer Society*, May/June 2010, Volume 14, Number 3, pp. 9-12.

Giardine B., Riemer C., Hardison R.C., Burhans R., Elnitski L., Shah P., Zhang Y., Blankenberg D., Albert I., Miller W. (2005), “Galaxy: a platform for interactive large-scale genome analysis”, *Genome Research*. 2005;15, pp. 1451-1455.

Greene S., Jones L., Matchen P., Thomas J. (2003), “Iterative development in the feild”, *IBM Systems Journal*, Volume 42, Issue 4, 2003.

Hack C. and Kendall G. (2005), “Bioinformatics: Current practice and future challenges for life science education”, *Biochemistry and Molecular Biology Education*, Volume 33, Issue 2, pp. 82–85, March 2005

Held M., Blochinger W. and Werning M. (2009), “E-Biology Workflows with Calvin”, *Lecture Notes in Computer Science*, 2009, Volume 5802/2009, pp. 581-588.

Hull D., Wolstencroft, K., Stevens, R., Goble C., Pocock M.R., Li.P. and Oinn T. (2006), “Taverna: a tool for building and running workflows of services”, *Nucleic Acids Research*., Volume 34, pp. 729-732.

Johnson M., Zaretskaya I., Raytselis Y., Merezhuk Y, McGinnis S. and Madden T.L. (2008), “NCBI BLAST: a better web interface”, *Nucleic Acids Research*, Volume 36, Issue supplement 2, pp. 5-9.

Knights M. (2007), “Web 2.0”, *IET Communications Engineer*, February/March 2007.

Kirakowski J. and Cierlik B. (1999), “Context of Use: Introductory Notes”, Human Factors Research Group (HFRG), Cork.

Kitinger J. (1994), “The methodology of focus groups: the importance of interaction between research and participants”, *Sociology of Health & Illness*, 16:103-21.

Kumar s. and Dudley J. (2007), “Bioinformatics software for biologists in the genomics era”, *Bioinformatics* (2007) 10.1093/bioinformatics/btm239.

Liu X., Wu J., Wang J., Liu X., Zhao S., Li Z., Kong L., Gu X., Luo J. and Gao G. (2009), “WebLab: a data-centric, knowledge-sharing bioinformatic platform”, *Nucleic Acids Research*, 2009, Vol. 37, Supplement number 2, pp. 33-39.

Lushbough C., Bergman M.K., Lawrence C.J., Jennewein D. and Brendel V. (2008), “Bioextract server: an integrated workflow-enabling system to access and analyze heterogeneous, distributed biomolecular data”, *IEEE/ACM Transactions on Computational Biology and Bioinformatics*. 2008;99.

Luscombe N.M., Greenbaum D. and Gerstein M. (2001), “What is Bioinformatics? A Proposed Definition and Overview of the Field”, *Methods of Information in Medicine* 4/2001.

Luscombe N.M., Greenbaum D. and Gerstein M. (2001), “What is bioinformatics? An introduction and overview”, for the IMIA 2001 yearbook.

Tiwari A, Sekhar AK. (2007), “Workflow based framework for life science informatics”, *Computational Biology and Chemistry*. (2007) 31(5-6), pp. 305-319.

Shachak A., Shuval K. and Fine S. (2007), "Barriers and enablers to the acceptance of bioinformatics tools: a qualitative study", *Journal of the Medical Library Association*, 95(4) October 2007.

Sleator R., Shortall C. and Hill C. (2008), "Metagenomics", *Letters in Applied Microbiology*, ISSN 0266-8254.

Stein L. (2008), "Bioinformatics: alive and kicking", *Genome Biology* 2008, 9:114(doi:10.1186/gb-2008-9-12-114).

Stajich J. and Lapp H. (2006), "Open source tools and toolkits for bioinformatics: significance, and where are we?", *Briefings in Bioinformatics*, Volume 7, Number 3, pp. 287-296.

Wharton, C., Rieman, J., Lewis, C., and Polson, P. (1994), "The cognitive walkthrough method: a practitioner's guide", *Usability inspection methods*, John Wiley & Sons, Inc., New York, NY, 1994.



# *Campylobacter ureolyticus* – An emerging gastrointestinal pathogen?

Susan Bullman<sup>1</sup>, Daniel Corcoran<sup>2</sup>, James O’Leary<sup>2</sup>, Brigid Lucey<sup>1&2\*</sup>,  
Deirdre Byrne<sup>2</sup> and Roy. D. Sleator<sup>1</sup>.

<sup>1</sup>Department of Biological Sciences, Cork Institute of Technology,  
Bishopstown, Cork, Ireland

\*E mail: brigid.lucey@cit.ie

<sup>2</sup>Department of Medical Microbiology, Cork University Hospital, Wilton, Cork,  
Ireland

## Abstract

A total of 7,194 faecal samples collected over a one year period, from patients presenting with diarrhoea were screened for *Campylobacter* spp. using EntericBio<sup>®</sup>, a multiplex-PCR system. Of 349 *Campylobacter*-positive samples, 23.8% were shown to be *Campylobacter ureolyticus*, using a combination of 16S rRNA analysis and highly specific primers targeting the HSP60 gene of this organism. This is, to the best of our knowledge, the first report of *C. ureolyticus* in the faeces of patients presenting with gastroenteritis and may suggest a role for this organism as an emerging enteric pathogen.

## Keywords

*Campylobacter ureolyticus*, *Campylobacter*, gastroenteritis, pathogenic, PCR

## 1. Introduction

*Campylobacter* spp. are the most common cause of bacterial enteritis worldwide, surpassing the other major bacterial enteric pathogens; *Salmonella* spp, *Shigella* spp and *Escherichia coli* O157 (Galanis 2007, Tauxe 2002). Campylobacterosis is primarily regarded as a zoonosis and the reservoirs for infection vary depending upon the particular *Campylobacter* species, but encompass a wide range of birds, livestock and domestic animals (McClurg et al. 2002, Moore et al. 2005). To date 26 species belong to the *Campylobacter* genus (Euzebey 2010), however only a fraction of these have been link with human gastroenteritis (Moore et al. 2005, Mandrell et al. 2005). *C. jejuni* and *C. coli* combined, have been reported to account for approximately 95% of *Campylobacter* related gastroenteritis in humans (Moore et al. 2005, Kulkarni et al. 2002), when using traditional culture methods for diagnosis.

However, advances in molecular diagnostics have highlighted that atypical and emergent *Campylobacter* spp are also detectable from clinical samples (Bullman et al. 2010, Duffy G et al. 2007); so far the true contribution of non *C. jejuni* and *C. coli* species to human gastroenteritis remains unknown.

In a recent study of enteric pathogen detection techniques, conducted at Cork University Hospital (CUH) in Ireland, O'Leary *et al* (O'Leary *et al.* 2009), compared conventional stool culture methods, using Preston agar (*Campylobacter* agar base [CM689; Oxoid, Basingstoke, United Kingdom] with supplement SR204E) under microaerobic conditions (5 % O<sub>2</sub>, 10% CO<sub>2</sub>, 85% N) at 42°C, with the EntericBio® system (Serosep Ltd., Limerick, Ireland), a multiplex-PCR based detection system for the rapid, simultaneous detection of *Campylobacter* spp, *Salmonella* spp, *Shigella* spp and *E.coli* O157 at the molecular level. In this study, it was reported that 28.6% of the samples positive for *Campylobacter* spp. using the multiplex-PCR method, failed to grow on routine culture. Taking into account the inherent difficulty of *Campylobacter* spp isolation, this observation, together with a clinical history of diarrhoea, suggests that traditional culture methods may fail to detect a significant proportion of genuine *Campylobacter* infections; a finding which, given the widespread dependence on culture based diagnostic techniques, raises significant public health concerns. The initial focus of the current study was thus to investigate the observed discrepancy between culture- and molecular based detection methods.

## 2. Methods and Materials

### 2.2 Patient samples

A total of 7,194 faecal samples collected over a one year period, from patients presenting with diarrhoea were screened for *Campylobacter* spp. using EntericBio® (Serosep Ltd., Limerick, Ireland). Of these a total of 349 DNA samples were included in the study. These samples, stored at -20°C, were extracted from anonymised faecal samples that tested positive for *Campylobacter* genus using the EntericBio®. The samples were received by the Department of Medical Microbiology at Cork University Hospital, Ireland, between January 2009 and December 2009, from patients with symptoms of acute gastroenteritis.

### 2.3 Control strains

The following control isolates were used in the study: *Campylobacter jejuni* subsp *jejuni* DSM 4688, *Campylobacter coli* DSM 4689, *Campylobacter lari* subsp *lari* DSM 11375, *Campylobacter fetus* subsp *fetus* DSM 5361 *Campylobacter upsaliensis*

DSM 5365, *Campylobacter hyointestinalis* subsp *hyointestinalis* DSM 19053 and *Campylobacter ureolyticus* DSM 20703. All control strains were obtained from DSMZ, Braunschweig, Germany.

## 2.4 PCR template preparation

DNA was extracted from the faecal samples using the EntericBio<sup>®</sup> system in accordance with the manufacturer's instructions. The extracted DNA were either used directly in the EntericBio<sup>®</sup> system or stored at -20°C until further use.

## 2.5 Primer design and validation:

Using MegaAlign and primer select (DNASTAR), *C. ureolyticus* species-specific PCR primer set (Table 1) targeting a region of the heat shock protein (*hsp60*) gene of *C. ureolyticus* were designed from sequences submitted to GenBank. The accession numbers for the HSP60 gene sequences of strains LMG 24746, R-37890, LMG 6451, LMG 24747, R-38115, and LMG 8448 are FN421436 through FN421441, respectively. *In silico* analysis confirmed that the regions to which CU-HSP60 F and CU-HSP60 R bind are specifically targeted to *C. ureolyticus* and at the annealing temperature used (61°C), are highly unlikely to bind to any *Campylobacter* species, or indeed any other enteric organisms in the National Centre for Biotechnology Information (NCBI) non-redundant database. The specificity of this assay was further assessed by wet lab analysis, whereby the DSMZ control strains *Campylobacter jejuni* subsp *jejuni* DSM 4688, *Campylobacter coli* DSM 4689, *Campylobacter lari* subsp *lari* DSM 11375, *Campylobacter fetus* subsp *fetus* DSM 5361 *Campylobacter upsaliensis* DSM 5365, *Campylobacter hyointestinalis* subsp *hyointestinalis* DSM 19053 all tested negative for the *C. ureolyticus* species specific PCR. Thus, the *hsp60* locus amplified by CU-HSP60 F and CU-HSP60 represents a specific biomarker for *C. ureolyticus*.

Species	Primer	Primer sequence (5' to 3')	Annealing temp (°C)	Product (bp)	Reference
Genus <i>Campylobacter</i>	C412F C1228R*	GGATGACACTTTTCGGAGC CATTGTAGCACGTGTGTC	61	816	(Linton et al. 1996)
<i>C. jejuni</i>	Hip400F HIP 1134R	GAAGAGGGTTTGGGTGGTG AGCTAGCTTCGCATAATAA CTTG	62	736	(Linton et al. 1997)
<i>C. coli</i>	CC18F CC519R	GGTATGATTTCTACAAAGC GAG ATAAAAGACTATCGTCGTC GCGTG	56	502	(Linton et al. 1997)
<i>C. lari</i>	CLF CLR	TAGAGAGATAGCAAAGAG A TACACATAATAATCCCACC C	53	251	(Wang et al. 2002)
<i>C. fetus</i>	MG3F CF359R	GGTAGCCGCAGCTGCTAAG AT AGCCAGTAACGCATATTAT AGTAG	56	359	(Hum et al. 1997)
<i>C. hyointestinalis</i>	HYO1F HYOFE T23SR	ATAATCTAGGTGAGAATCC TAG GCTTCGCATAGCTAACAT	53	611	(Inglis and Kalischuk 2003)
<i>C. upsaliensis</i>	CUF CUR	AATTGAAACTCTTGCTATCC TCATACATTTTACCCGAGCT	51	204	(Wang et al. 2002)
<i>C. ureolyticus</i>	CU- HSP60 F CU- HSP60 R	GAAGTAAAAAGAGGAATGG ATAAAGAAGC CTTCACCTTCAATATCCTCA GCAATAATTAAGA	61	429	(Bullman et al. 2010)

\*Inglis & Kalischuk (Inglis and Kalischuk 2003) reported a typographical error in the paper Linton et al (Linton et al. 1996): Primer C1288R should have read primer C1228R.

**Table 1: PCR primers and annealing temperatures**



## 2.6 PCR assay:

A total of 349 DNA samples were investigated using uniplex species-specific PCR assays for *C. jejuni*, *C. coli*, *C. lari*, *C. fetus*, *C. hyointestinalis*, *C. upsaliensis* and *C. ureolyticus*, respectively. The primer sequences used in the species-specific uniplex PCRs are outlined in Table 1. All PCR amplifications were performed in a mixture (25  $\mu$ l) containing 3 $\mu$ l of template DNA, 12.5 $\mu$ l of 2x BioMix Red (MyBio Ltd. , Kilkenny, Ireland ), 8.5  $\mu$ l of molecular grade water and 1 $\mu$ l of the selected species-specific primer pair (25pmol/ $\mu$ l). The cycling was as follows: 35 cycles of denaturation at 95°C for 30 seconds, annealing at a temperature specific to the primer pair (as outlined in Table 1) for 1 minute and extension at 75 °C for 30 seconds. PCR amplicons were visualised after electrophoresis in 1.5% agarose gels stained with ethidium bromide and photographed under UV light. HyperLadder II (BioLine) which has a range of 50-2000 bp was used as the molecular weight marker.

## 2.7 16S rRNA Sequencing:

A *Campylobacter* genus-specific PCR targeting the 16s rRNA was conducted on DNA samples that were negative for species-specific PCR (see Table 1). Samples that produced a PCR amplicon were subject to 16s rRNA sequence analysis. Returned sequences were subjected to BLAST analysis using the NCBI database and aligned by the ClustalW method in Megalign from the Lasergene suite of programs (DNASTar). Clinical strains were considered to be identified when sequence similarities with GenBank entries exceeded 99% identity over the entire length of the sequence.

## 2.8 Data collection:

Upon receipt into the Microbiology laboratory, each patient sample was assigned a unique specimen record number; details of the patients' age and sex along with sample details and collection information were entered onto the hospital database.

## 3. Results

### 3.1 EntericBio<sup>®</sup> *Campylobacter* positives

Of 7,194 patient faecal samples submitted to the Microbiology Laboratory from January - December of 2009, a total of 349 samples were determined to be

*Campylobacter*-genus positive by the EntericBio<sup>®</sup> molecular method. A total of 340 samples of the 349 patient samples which were positive by the EntericBio<sup>®</sup> molecular method were confirmed by alternative molecular methods (species-specific or genus-specific PCR) and/or routine culture to be true *Campylobacter* positives.

### 3.2 *Campylobacter ureolyticus* Investigation

*Campylobacter* species-specific PCR (primers outlined in Table1) for the six most common *Campylobacter* spp. in human gastroenteritis (Moore et al. 2005); *C. jejuni*, *C. coli*, *C. lari*, *C. fetus*, *C. upsaliensis* and *C. hyointestinalis* confirmed the presence of *Campylobacter* spp in 275 (78.8%) of the 349 EntericBio<sup>®</sup> positive samples. Of the 74 (21.2%) samples which gave negative results for the *Campylobacter* species-specific PCR assays, 62 samples were positive for *Campylobacter* genus-specific PCR, targeting the 16S rRNA. A representative sample of these *Campylobacter* genus positive samples was sequenced and in each case, BLAST analysis revealed  $\geq 99\%$  identity (over the entire length of the sequence) to the *Campylobacter ureolyticus* type strain NCTC 10941T/ DSM 20703. All 340 confirmed *Campylobacter* positive samples were retrospectively screened using the *C. ureolyticus* specific *hsp60* gene target. *C. ureolyticus* was detected in 83 samples representing 24.4% of all *Campylobacter* positive samples. Of these, 53 samples were *C. ureolyticus* positive in the absence of any other common bacterial pathogen and a total of 30 *C. ureolyticus* positive samples were found to exist as mixed isolates with other *Campylobacter* species.

### 3.3 Clinical Follow up of *C. ureolyticus* positive patients

A random subset (n=8) of patients presenting with diarrhoeal illness whereby *C. ureolyticus* was the sole organism detected, were followed up clinically. In this study, five patients (three females and two males) were  $\geq 69$  years of age, two patients; one female and one male were 6 and 1 years of age respectively and one male was 52 years of age. All patients presented with abdominal cramping and reported symptoms lasting for a minimum of five days. Furthermore, within this subset, four patients were immunocompromised; two had diabetes mellitus, one patient had a HIV-associated Burkitt's lymphoma.

## 4. Discussion and Conclusions

*Campylobacter* infections continue to be a significant public health issue, not only in terms of morbidity but also economic cost. In 2006, a total of 175,561 confirmed cases of campylobacteriosis were reported from 21 European countries (EFSA

2009), a figure which is thought to be significantly underestimated (Janssen et al. 2008, Moore et al. 2005). Furthermore, the annual cost of *Campylobacter* infection in the US is estimated to be at least \$8 billion; a large economic burden (Crushell et al. 2004). Based upon routine culture detection in the diagnostic laboratories *C. jejuni* and *C. coli* have been reported to be the most prevalent *Campylobacter* spp. causing human disease and as a result, the past three decades has witnessed the majority of *Campylobacter* research focus largely on these two species. The beginning of the 21<sup>st</sup> century has observed considerable advances in diagnostic methods; which in turn have led to the generation of numerous reports reemphasising the limitations of routine *Campylobacter* culture for the detection of non *C. jejuni*/*C. coli* spp (O'Leary et al. 2009, Lastovica and le Roux 2000, Maher et al. 2003, Bullman et al. 2010). Thus, traditional culture masks the true incidence of both *Campylobacter* related gastroenteritis and also the atypical and emerging campylobacteria that are detectable in cases of gastroenteritis (Bullman et al. 2010, Lastovica and le Roux 2000, Maher et al. 2003).

*Campylobacter ureolyticus* has recently been re-classified from its previous classification as *Bacteroides ureolyticus*, on the basis of protein profiles and molecular analysis of conserved genes (Vandamme et al. 2010). While the similarity between *C. ureolyticus* and members of the *Campylobacter* genus has been acknowledged on genotypic grounds (Vandamme et al. 1995, B.J Paster 1988), differences in protein metabolism and fatty acid composition has meant that, until now, it remained in the category of species '*incertae sedis*' (Vandamme et al. 1995).

A retrospective analysis of faecal samples submitted to CUH in 2009 was performed to identify, to species level, all *Campylobacter* strains detected using the EntericBio system in a single calendar year. Using the highly specific *C. ureolyticus* primer pair CU-HSP60-F and CU-HSP60-R, we have detected *C. ureolyticus* in the faeces 73 patients presenting with gastroenteritis, in which there were 53 cases where *C. ureolyticus* was isolated from faecal samples in the absence of the other common bacterial enteric pathogens. DNA extracted from the type strain for *C. ureolyticus* (NCTC 10941T/ DSM 20703) (Vandamme et al. 2010) tested positive for *Campylobacter* spp. when tested with the EntericBio® system. Routine culture on the other hand, failed to detect the organism from samples that were PCR positive for *C. ureolyticus* only. Vandamme *et al* (Vandamme et al. 2010), have reported that *C. ureolyticus* is incapable of growing in the microaerobic atmosphere used in routine *Campylobacter* culture (5% O<sub>2</sub>, 10% CO<sub>2</sub> and 85% N<sub>2</sub>) with common agar bases unless hydrogen is supplied. The EntericBio system thus displays significantly improved sensitivity over traditional culture methods for the detection of diverse species of *Campylobacter* or *Campylobacter*-like organisms. Furthermore, given that only 1.15% of the 7,194 samples processed using the EntericBio system were noted

to contain *C. ureolyticus* it seems unlikely that this organism exists as a common commensal of the gastrointestinal tract. Indeed, prior to this study, reports of *C. ureolyticus* have been rare, being isolated only from patients with superficial soft tissue or bone infections, non-gynaecological non-chlamydial urethritis, bacterial vaginosis, and periodontal disease (Duerden et al. 1987, Duerden et al. 1989, Fontaine et al. 1986, Mazuecos et al. 1998). Moreover, it has rarely been the sole isolate from these sites of infection, with most findings reporting the presence of other organisms which may have been contributing to pathogenesis (Akhtar and Eley 1992, Duerden et al. 1982). Within the past decade, there has been a dearth of clinical studies investigating *C. ureolyticus*, indeed, the current study represents the first report identifying the presence of *C. ureolyticus* in the faeces of patients presenting with diarrhoeal illness.

Interestingly, this organism is reported to be urease positive (Vandamme et al. 2010), which is unusual for *Campylobacter* species. Previously, Matsuda and Moore (Matsuda and Moore 2004) have reported the presence of urease positive thermophilic *Campylobacter* (UPTC) in the natural environmental, however they did not detect these organisms in any of the human faeces samples in their study. It would be of interest to investigate the similarity between the environmental UPTC isolates detected by Matsuda and Moore [2004] and the urease positive *C. ureolyticus* which we have detected in clinical samples.

The detection of this organism by the EntericBio system further validates the molecular method for the identification of *Campylobacter* spp. Until such time as we have gained a greater understanding of the clinical impact of *C. ureolyticus* on human health, it is difficult to consider the true value of *C. ureolyticus* detection in diagnostic laboratories.

In conclusion then, this is the first report to identify the presence of *C. ureolyticus* in the faeces of patients presenting with diarrhoeal illness, suggesting its possible role as a novel gastrointestinal pathogen. We are currently in the process of assessing the clinical significance of our findings and the implications that these results may have for patient health and infection control.

## 5. Acknowledgements

SB is supported by a scholarship from the Irish Research Council for Science, Engineering and Technology (RS/2009/1670). RDS is an ESCMID Fellow. Funding was provided by Serosep Ltd, Ireland. The authors declare that they have no competing interests.

## 6. References

- Akhtar, N. and Eley, A. (1992) 'Restriction endonuclease analysis and ribotyping differentiate genital and nongenital strains of *Bacteroides ureolyticus*', *J Clin Microbiol*, 30(9), 2408-14.
- B.J Paster, F. E. D. (1988) 'Phylogeny of campylobacters, wolinellass, *Bacteroides gracilis*, and *Bacteroides ureolyticus* by 16s ribosomal ribonucleic acid sequencing. ', *Int. J. Syst. Bacteriol*, 38, 56-62.
- Bullman, S., Corcoran, D., O'Leary, J., Lucey, B., Byrne, D. and Sleator, R. D. (2010) 'Campylobacter ureolyticus – An emerging gastrointestinal pathogen?', *FEMS Immunol and Med Microbiol*, In press.
- Crushell, E., Harty, S., Sharif, F. and Bourke, B. (2004) 'Enteric campylobacter: purging its secrets?', *Pediatr Res*, 55(1), 3-12.
- Duerden, B., Bennet, K. W. and Faulkner, J. (1982) 'Isolation of *Bacteroides ureolyticus* (B corrodens) from clinical infections', *J Clin Pathol*, 35(3), 309-12.
- Duerden, B. I., Eley, A., Goodwin, L., Magee, J. T., Hindmarch, J. M. and Bennett, K. W. (1989) 'A comparison of *Bacteroides ureolyticus* isolates from different clinical sources', *J Med Microbiol*, 29(1), 63-73.
- Duerden, B. I., Goodwin, L. and O'Neil, T. C. (1987) 'Identification of *Bacteroides* species from adult periodontal disease', *J Med Microbiol*, 24(2), 133-7.
- Duffy G, Cagney C and Lynch, O. (2007) *Recovery and identification of emerging Campylobacteria from food*. Teagasc
- EFSA (2009) 'Community Summary Report – Trends and Sources of Zoonoses and Zoonotic Agents in the European Union in 2007', *The EFSA Journal*, 130, 108-133.
- Euzeby, J. P. (2010) 'List of Prokaryotic names with Standing in Nomenclature; a folder available on the Internet 2010.', [online], available: [www.bacterio.net](http://www.bacterio.net) [accessed
- Fontaine, E. A., Bryant, T. N., Taylor-Robinson, D., Borriello, S. P. and Davies, H. A. (1986) 'A numerical taxonomic study of anaerobic gram-negative bacilli classified as *Bacteroides ureolyticus* isolated from patients with non-gonococcal urethritis', *J Gen Microbiol*, 132(11), 3137-46.
- Galanis, E. (2007) 'Campylobacter and bacterial gastroenteritis', *CMAJ*, 177(6), 570-1.

Hum, S., Quinn, K., Brunner, J. and On, S. L. (1997) 'Evaluation of a PCR assay for identification and differentiation of *Campylobacter fetus* subspecies', *Aust Vet J*, 75(11), 827-31.

Inglis, G. D. and Kalischuk, L. D. (2003) 'Use of PCR for direct detection of *Campylobacter* species in bovine feces', *Appl Environ Microbiol*, 69(6), 3435-47.

Janssen, R., Krogfelt, K. A., Cawthraw, S. A., van Pelt, W., Wagenaar, J. A. and Owen, R. J. (2008) 'Host-pathogen interactions in *Campylobacter* infections: the host perspective', *Clin Microbiol Rev*, 21(3), 505-18.

Kulkarni, S. P., Lever, S., Logan, J. M., Lawson, A. J., Stanley, J. and Shafi, M. S. (2002) 'Detection of *campylobacter* species: a comparison of culture and polymerase chain reaction based methods', *J Clin Pathol*, 55(10), 749-53.

Lastovica, A. J. and le Roux, E. (2000) 'Efficient isolation of *campylobacteria* from stools', *J Clin Microbiol*, 38(7), 2798-9.

Linton, D., Lawson, A. J., Owen, R. J. and Stanley, J. (1997) 'PCR detection, identification to species level, and fingerprinting of *Campylobacter jejuni* and *Campylobacter coli* direct from diarrheic samples', *J Clin Microbiol*, 35(10), 2568-72.

Linton, D., Owen, R. J. and Stanley, J. (1996) 'Rapid identification by PCR of the genus *Campylobacter* and of five *Campylobacter* species enteropathogenic for man and animals', *Res Microbiol*, 147(9), 707-18.

Maher, M., Finnegan, C., Collins, E., Ward, B., Carroll, C. and Cormican, M. (2003) 'Evaluation of culture methods and a DNA probe-based PCR assay for detection of *Campylobacter* species in clinical specimens of feces', *J Clin Microbiol*, 41(7), 2980-6.

Mandrell, R. E., Harden, L. A., Bates, A., Miller, W. G., Haddon, W. F. and Fagerquist, C. K. (2005) 'Speciation of *Campylobacter coli*, *C. jejuni*, *C. helveticus*, *C. lari*, *C. sputorum*, and *C. upsaliensis* by matrix-assisted laser desorption ionization-time of flight mass spectrometry', *Appl Environ Microbiol*, 71(10), 6292-307.

Matsuda, M. and Moore, J. E. (2004) 'Urease-positive thermophilic *Campylobacter* species', *Appl Environ Microbiol*, 70(8), 4415-8.

Mazuecos, J., Aznar, J., Rodriguez-Pichardo, A., Marmesat, F., Borobio, M. V., Perea, E. J. and Camacho, F. (1998) 'Anaerobic bacteria in men with urethritis', *J Eur Acad Dermatol Venereol*, 10(3), 237-42.

- McClurg, K. R., McClurg, R. B., Moore, J. E. and Dooley, J. S. (2002) 'Efficient isolation of campylobacters from stools: what are we missing?', *J Clin Pathol*, 55(3), 239-40.
- Moore, J. E., Corcoran, D., Dooley, J. S., Fanning, S., Lucey, B., Matsuda, M., McDowell, D. A., Megraud, F., Millar, B. C., O'Mahony, R., O'Riordan, L., O'Rourke, M., Rao, J. R., Rooney, P. J., Sails, A. and Whyte, P. (2005) 'Campylobacter', *Vet Res*, 36(3), 351-82.
- O'Leary, J., Corcoran, D. and Lucey, B. (2009) 'Comparison of the EntericBio multiplex PCR system with routine culture for detection of bacterial enteric pathogens', *J Clin Microbiol*, 47(11), 3449-53.
- Tauxe, R. V. (2002) 'Emerging foodborne pathogens', *Int J Food Microbiol*, 78(1-2), 31-41.
- Vandamme, P., Daneshvar, M. I., Dewhirst, F. E., Paster, B. J., Kersters, K., Goossens, H. and Moss, C. W. (1995) 'Chemotaxonomic analyses of *Bacteroides gracilis* and *Bacteroides ureolyticus* and reclassification of *B. gracilis* as *Campylobacter gracilis* comb. nov.', *Int J Syst Bacteriol*, 45(1), 145-52.
- Vandamme, P., Debruyne, L., De Brandt, E. and Falsen, E. (2010) 'Reclassification of *Bacteroides ureolyticus* as *Campylobacter ureolyticus* comb. nov., and emended description of the genus *Campylobacter*', *Int J Syst Evol Microbiol*, 60(Pt 9), 2016-22.
- Wang, G., Clark, C. G., Taylor, T. M., Pucknell, C., Barton, C., Price, L., Woodward, D. L. and Rodgers, F. G. (2002) 'Colony multiplex PCR assay for identification and differentiation of *Campylobacter jejuni*, *C. coli*, *C. lari*, *C. upsaliensis*, and *C. fetus* subsp. *fetus*', *J Clin Microbiol*, 40(12), 4744-7.





# Design & Evaluation of a Novel Material for Peripheral Nerve Regeneration

Xiao Fang Zhang<sup>1</sup>, Sharon Kehoe<sup>2</sup>, Aoife Burke<sup>1</sup>, Helen O'Shea<sup>3</sup>, Daniel Boyd<sup>2</sup>

1. Therapeutic Biomaterial Unit, Medical Engineering Design and Innovation Centre (MEDIC), Cork Institute of Technology, Ireland
2. Dept. of Applied Oral Sciences, Dalhousie University, Halifax, NS, B3H 3J5, Canada.
3. Department of Biological Sciences, Cork Institute of Technology, Ireland.  
e-mail: xiaofang.zhang@cit.ie

## Abstract

Bioglass has demonstrated excellent biocompatibility both *in vitro* and *in vivo* for tissue engineering applications. More recently researchers have sought to develop a bioactive glass which can be combined with polymers to form a biodegradable composite scaffold to bridge peripheral nerve defects. In this study, a novel series bioactive glass with mol% of  $(0.5\text{SiO}_2 - 0.2\text{CaO} - 0.13\text{ZnO} - X\text{Na}_2\text{O} - (0.27 - X)\text{CeO}_2)$  where,  $(0 < X < 0.14)$  was synthesized through normal melting-quenching methods; the composition being based on elements known to elicit a positive response on regenerating nerve tissue. The glass was characterised by X-Ray Diffraction (XRD), Brunnauer Emmett Teller (BET) Surface Area Determination, Particle Size Analysis and Scanning Electron Microscopy (SEM). Following characterization, the cytocompatibility of each glass composition was evaluated by means of a 3-(4, 5-dimethylthiazol-2-yl)-2,5-diphenyltetrazolium bromide (MTT) assay on the L929 (mouse adipose fibroblast) cell line. MTT assay results reveal that the glass compositions can be tailored to provoke no significant cytotoxicity in terms of cell viability. Specifically, as X (mol %) increases the cell viability improves in the design range. A value of  $X=0.14$  offers the best cell viability equivalent to (93-102%) versus the negative control (Tissue Culture water). In conclusion, the glass compositions investigated demonstrate suitable cell viabilities *in vitro*. This specific glass composition will now be incorporated into a polymer-glass scaffold as a nerve guidance conduit.

## Keywords

Nerve guidance conduits (NGC), Bioactive glass, Cell culture, MTT assay

## 1. Introduction

Peripheral Nerve Injury (PNI) is a common form of trauma, with up to 300,000 cases each year in Europe. The current clinical gold standard for nerve repair is autografting (a nerve segment taken from the same individual of lesser functional importance to bridge the nerve defects); which has a number of disadvantages (such as (i) donor site morbidity, (ii) second surgery requirement, (iii) occurrences of

neuroma formation and (iv) limited availability etc. (Joshi et al., 1995, Hadlock et al., 1998, Matejcek, 2002, Freilinger, 1995-01-01); Current state of the art nerve guidance conduits (NGCs) are constructed using both biological and synthetic biomaterials, such as collagen and poly (DL-lactide-co- $\epsilon$ -caprolactone). However, these materials have inherent difficulties; biological collagen conduits elicit undesirable immunological responses and require the use of immunosuppressive drugs. Synthetic poly (DL-lactide-co- $\epsilon$ -caprolactone) conduits, however, are associated with the biodegradation of the NGC to non-therapeutic acidic components and the adverse effect is nerve compression due to insufficient degradation. Numerous studies indicate the shortcomings of these nerve grafts for repairing long-distance nerve defects in humans.

Synthetic composition material could be advantageous for NGCs since scaffold properties could be tailored for specific applications, thus enabling the achievement of optimal conditions for releasing growth factor and providing mechanical supports for peripheral nerve reconstruction (2001). Hench (Hench, 2009) demonstrated that Bioglass could bond to both hard and soft tissues *in vivo*. Thus, the design of Polymer/ Glass composite materials offers an exceptional opportunity for combining bioresorbable polymers and bioactive glass phases with tailored physical, biological and mechanical properties can be produced (Boccaccini and Maquet, 2003). There is increasing interest in investigating the application potential of Bioglass in tissue engineering soft tissues, both as filler or coating of polymers (Boccaccini and Maquet, 2003). (Bunting et al., 2005) demonstrated that “cultured rat Schwann cells and fibroblasts grow on Bioglass<sup>®</sup> fibers *in vitro* using SEM and immunohistochemistry, and provide qualitative and quantitative evidence of axonal regeneration through a Silastic conduit filled with Bioglass<sup>®</sup> fibers *in vivo*”. Moreover, BG/polyhydroxybutyrate (PHB) composites (André Oliveira Paivaa, 2006), also demonstrate *in vitro* biocompatibility for use in augmentation of peripheral nervous tissue. Such composites are found to exhibit a strong interaction with soft tissue (Boccaccini and Maquet, 2003, Day et al., 2004). Thus, the investigation of new bioactive glass compositions designed to mediate specific host responses in nerve regrowth applications is valuable, and may provide for improved outcomes in respect of peripheral nerve regeneration. The Si-Na-Ca-Zn-Ce glass system (CNG glass) designed by author has shown its controllable degradation rate (X.F.Zhang, 2010), which may be exploited to favourable alter the *in vitro* cytocompatibility.

The present study involved synthesis of CNG glass composite based on elements known to elicit a positive response on regenerating nerve tissue. The *in vitro* cytocompatibility of Ca–Ce–Na–Zn–Si glasses were evaluated according to ISO 10993-5 (Standard, 2009a). L929 mouse fibroblast cells and the MTT assay were employed as they are the standard model recommended for cytotoxicity testing by measuring cell viability and proliferation.

## 2. Materials and Methods

### 2.1. Glass Synthesis

Three experimental glass formulations were synthesized (Table 1). Glasses were prepared by weighing out the appropriate amounts of analytical grade reagents (Sigma-Aldrich, Wicklow, Ireland); silicon dioxide, zinc oxide, calcium carbonate, cerium oxide and sodium carbonate into a plastic container. Each formulation was thoroughly mixed in the closed container for 30 min. Compositions were then fired (1520°C for 1 h) in platinum crucibles and the glass melts shock quenched into water. The resulting frit was dried in an oven at 120°C for 1 day, ground and then sieved to retrieve a glass powder with a particle size <45µm.

Glass ID	SiO <sub>2</sub>	Na <sub>2</sub> O	CaO	ZnO	CeO <sub>2</sub>
CNG – 1	0.5	0.04	0.2	0.13	0.13
CNG – 2	0.5	0.09	0.2	0.13	0.08
CNG – 3	0.5	0.14	0.2	0.13	0.03

**Table 1: The defined bioactive glass composites**

### 2.2. XRD

To confirm the amorphous nature of the glasses, X-ray diffraction (XRD) analysis was performed on each composition using a Philips Xpert MPD Pro 3040/60 X-ray Diffraction (XRD) Unit (Philips, Netherlands). Disc samples (Ø32mm\*× 3mm) were prepared by pressing a selected glass particles (<45µm), the Anode material is Cu at Generator voltage of 40KV and 35 mA for current. The scan angle range was 10°<2θ<70°, at scan step size 0.033423° and a step time of 59.69 seconds.

### 2.3. Particle Size Analysis

The determination of mean particle size and particle size distributions was carried out using a Malvern Mastersizer Type S Laser Diffractometer. The dynamic range of the Malvern Mastersizer S was at 0.05 to 3500 microns. One g of sodium hexametaphosphate was mixed intensively via a magnetic stirrer in 1000ml of deionised water to act as a dispersant. Glass powder (0.5 g) of sample was dispersed in 30ml of the above prepared dispersant in an 80 - 100ml heavy-duty beaker. The wet method for powder sample preparation was used according to ISO 14887 (standardisation, 2000).

## 2.4. SEM

Surface morphology of each glass tubes were observed by an environmental scanning electron microscope (ESEM: Hitachi S-3700N Ultra Large Variable Pressure) operated at an accelerating voltage of 5 kV in back scattered electron mode with Energy Dispersive Spectrometer (EDS: Oxford Instruments) capability. Sample powder was carefully stacked onto each SEM sample. Secondary and backscattered electrons were used to generate 3D-like high resolution images.

## 2.5. Glass extract preparation

Each glass was sterilised using  $\lambda$  irradiation (Isotron, Westport, Co. Mayo, Ireland) in accordance with 'ISO11137: 2006; Sterilisation of healthcare products' (Standards, 2006). The minimum and maximum doses recorded during sterilisation were 30.5 and 30.8 kGy, respectively. The specific surface area of glass sample was determined as stated (X.F.Zhang, 2010). An equivalent surface area of 1 m<sup>2</sup> of sterilised glass were immersed in 10 ml of sterile tissue culture water (Sigma-Aldrich, Ireland) for 1, 3, 7 and 30 Days (n = 3) at 37°C in a dynamic Waterbath (Binder, Germany). After each storage period, samples were filtered using a sterile 0.20 mm<sup>2</sup> filter (Sarstedt, Ireland), and filtrates were stored at 4°C for future *in vitro* evaluation.

## 2.6. Cell Culture

The established mouse fibroblast cell line L929 (European Collection of Cell Cultures (ECACC), NCTC clone 929) was cultured in Dulbecco's Modified Eagle's Medium (DMEM, Sigma Aldrich, Ireland) supplemented with 10% foetal calf serum (FCS, Sigma Aldrich, Ireland), 1% (2mM) L-glutamine (Sigma Aldrich, Ireland), and 1% Tryptose Phosphate Broth TPB (Sigma Aldrich, Ireland). Cells were grown in T-75 flasks (Sarstedt, Ireland) at 37°C in a 5% CO<sub>2</sub> incubator. When the cells had reached confluence they were chemically removed using 0.25% trypsin (Sigma-Aldrich, Ireland), centrifuged and re-suspended in fresh culture media to create a new single cell suspension for further inoculation.

## 2.7. Cell viability assay

L929 cells (Section 2.6) were seeded at a density of 1x10<sup>4</sup>/ml in 24-well plates (Sarstedt, Ireland). DMEM culture media was incorporated as a negative control and culture media plus cells incorporated as a positive control. Plates were then incubated for 24 h in a cell culture incubator at 37°C (5 % CO<sub>2</sub>, 37 °C, > 90 % humidity) (Boyd *et al.*, 2009). After 24hrs incubation, 100  $\mu$ l of sterile tissue culture water was added to negative and positive control wells. Experimental samples (100  $\mu$ l, section 2.5) were added to appropriate wells for testing. The plate was then incubated for a further 24hrs in a cell culture incubator at 37°C (5 % CO<sub>2</sub>, 37 °C, > 90 % humidity) (Boyd *et al.*, 2009, Standard, 2009b). After 24hrs incubation, 100 $\mu$ l of culture medium of MTT was added to each well. Plates were then returned to the

incubator for 3hrs. Thereafter, 1ml of MTT solubilisation solution was added to each well of the plates to dissolve the resulting formazan crystal. The spectrophotometric absorption was measured (TriStar LB 941, Berthold Technologies, US) at a wavelength of 570nm (Boyd *et al.*, 2009). Cell positive control wells were assumed to have 100% metabolic activity corresponding to cellular viability of 100% and the percentage cell viability of the cells exposed to experimental extracts were calculated relative to this.

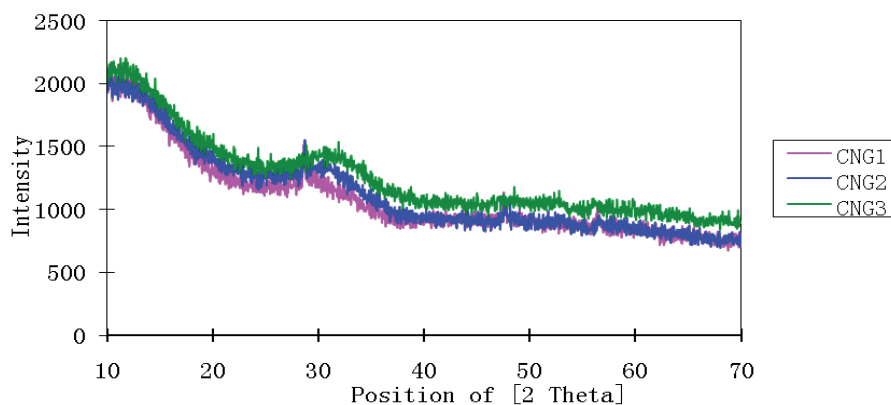
## 2.8. Statistical analysis

Each experiment was performed in triplicate and all data were expressed as means  $\pm$  standard deviation (SD). All measurements was analysed using GraphPad Prism 5.03 software (GraphPad software Inc.) and analysis of the results was carried out using Paired Students's t-test, with a significance level of  $P < 0.05$ .

## 3. Results and discussion

### 3.1. XRD

Figure 1 shows the XRD patterns of the glass. The amorphous hump indicated the amorphous nature of the glass, and there was no obvious peak, which indicates that no detectable crystalline species were present in the glass.

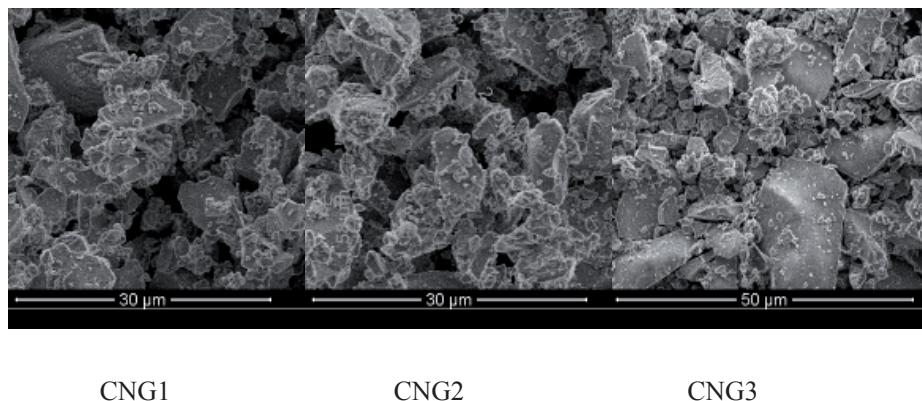


**Figure 1: The XRD patterns of the prepared glass compositions (CNG1 -3)**

### 3.2. Particle size analysis & SEM image

The CNG glass granules with mean particle sizes of 12.087, 8.427, and 7.49  $\mu\text{m}$  are referred as CNG1, CNG2, and CNG3, respectively. The SEM image (Figure 2) confirms the amorphous nature of the glass; it also indicates that the glasses are significantly less than 45  $\mu\text{m}$ . Recently, some studies have demonstrated anti-

microbial and anti-inflammatory properties on particulates of average particle size smaller than 100 nm (Sepulveda et al., 2001, Stoor et al., 1998) that are potentially very promising for regenerative medicine; there has been little research on the mechanisms of these antimicrobial and anti-inflammatory properties of these small particle size glasses, and it is difficult to elucidate the reason for this.



**Figure 2: Comparable glass surface morphology of 3 CNG glasses**

### 3.3. Biocompatibility

The MTT assay results displayed in Figure 3 were evaluated by percentage viability respective to controls. The cell viability for CNG1 in 7 day incubation is significantly higher in comparison with the cell viability of 1 day and 3 day incubation periods. For the cell viability of CNG2, the 7 day samples have the highest cell viability over all incubation periods, while there is a significant difference between the cell viability of 1 day and 3 day incubation periods. The only significant difference for the cell viability of CNG3 is between 1 day and 7 day incubation periods. The cell viability of all three CNG glasses has reached their maximum levels after the 7 day incubation period. The reason for this was believed to be due to the  $\text{Si}^{4+}$  release from the CNG glasses, according to the author's previous report (X.F.Zhang, 2010) on the ion release of the same glass, the ion release reached plateau level after 7 day incubation. Studies done by Frewin *et al.*, (Frewin et al., 2009) has shown that  $\text{Si}^{4+}$  release levels from bioactive glass have a positive effect on PC12 cells. As is indicated in the graph, the cell viability of the three CNG glasses is in the order of  $\text{CNG1} < \text{CNG2} < \text{CNG3}$ . Relative to the cell viability results with the particle size of each glass, the smaller particle size give the greater cell viability, possibly because the smaller particle size gives a larger surface area, leads to higher  $\text{Si}^{4+}$  release; therefore results in the better cell viability. The other reason for the highest cell viability indicated by CNG3 could be the higher  $\text{Na}^+$  content in the glass, Since the sodium is a glass network former, the greater the  $\text{Na}^+$  concentration present, the fast the silicon glasses will degrade (Boyd., 2005). The bioactive glass with mol% of  $(0.5\text{SiO}_2 - 0.2\text{CaO} - 0.13\text{ZnO} - \text{XNa}_2\text{O} - (0.27-\text{X}) \text{CeO}_2)$  where,  $(\text{X} = 0.04, 0.09, \text{ and } 0.14)$  were referred as glass CNG1, CNG2 and CNG3,

respectively. MTT assay results indicate that the glass compositions with  $x=0.14$  have the highest cell viability, equivalent to (93-102%) in the three glasses.

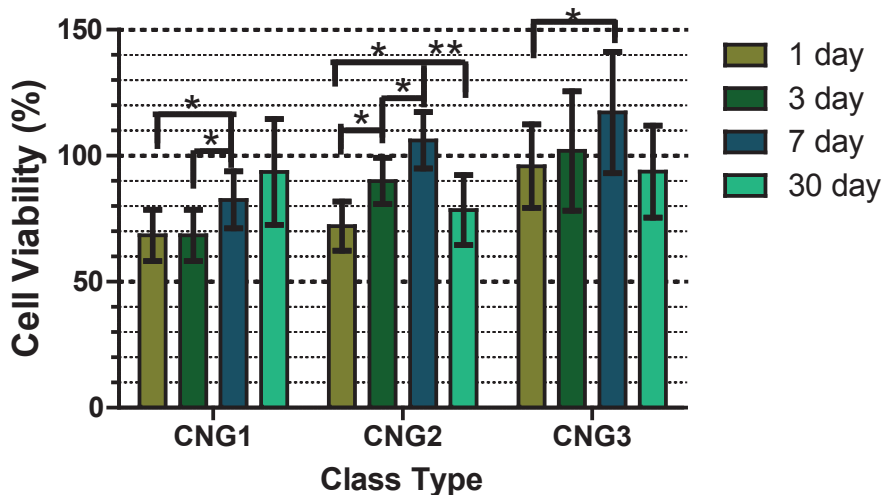


Figure 3: The cell viability of three CNG glass over 1, 3, 7, and 30 day incubation periods (\*,  $p<0.05$ ; \*\*,  $p<0.005$ )

#### 4. Conclusion

In conclusion, the CNG glasses can be tailored to provoke no significant cytotoxicity in terms of cell viability. Specifically, as the higher  $\text{Na}^+$  (mol %) enhances the cell viability in the design range. 14% of  $\text{Na}_2\text{O}$  contents in the glass offers the smallest particle size and the best cell viability versus the negative control (tissue culture water). This preliminary study demonstrates suitable cell viabilities *in vitro*. Future investigations on this specific glass composition will now be incorporated into a polymer-glass scaffold as a nerve guidance conduit. (Boyd et al., 2009)

#### 5. References

Abdr Oliveira Paivaa, M. G. D., Maria Helena Vaz Fernandesb Maria Helena Gil, Nec Sio Gomes Costa (2006) In Vitro Studies of Bioactive Glass/polyhydroxybutyrate Composites. *Material Research*, 9, 7.

Boccaccini, A. R. & Maquet, V. (2003) Bioresorbable and bioactive polymer/Bioglass? composites with tailored pore structure for tissue engineering applications. *Composites Science and Technology*, 63, 2417-2429.

Boyd, D., Murphy, S., Towler, M. R., Wren, A. W. & Hayakawa, S. (2009) Analysis of  $[\gamma]$ -irradiated synthetic bone grafts by  $^{29}\text{Si}$  MAS-NMR spectroscopy, calorimetry and XRD. *Journal of Non-Crystalline Solids*, 355, 2285-2288.

Boyd., D. (2005) Zinc-based glass polykenoate cements for skeletal applications. *Department of Materials Science & Technology*. Limerick, University of Limerick.

Bunting, S., Di Silvio, L., Deb, S. & Hall, S. (2005) Bioresorbable glass fibres facilitate peripheral nerve regeneration. *J Hand Surg Br*, 30, 242-7.

Day, R. M., Boccaccini, A. R., Shurey, S., Roether, J. A., Forbes, A., Hench, L. L. & Gabe, S. M. (2004) Assessment of polyglycolic acid mesh and bioactive glass for soft-tissue engineering scaffolds. *Biomaterials*, 25, 5857-5866.

Dumitriu, S. (2001) *Polymeric Biomaterial*, CRC Press.

Freilinger, R. K. M. F. M. R. M. D. G. (1995-01-01) Histological examination of graft donor nerves harvested by the stripping technique. *European Journal of Plastic Surgery*, 18, 3.

Frewin, C. L., Jaroszeski, M., Weeber, E., Muffly, K. E., Kumar, A., Peters, M., Oliveros, A. & Sadow, S. E. (2009) Atomic force microscopy analysis of central nervous system cell morphology on silicon carbide and diamond substrates. *Journal of Molecular Recognition*, 22, 380-388.

Hadlock, T., Elisseeff, J., Langer, R., Vacanti, J. & Cheney, M. (1998) A tissue-engineered conduit for peripheral nerve repair. *Arch Otolaryngol Head Neck Surg*, 124, 1081-6.

Hench, L. L. (2009) Genetic design of bioactive glass. *Journal of the European Ceramic Society*, 29, 1257-1265.

Joshi, N., Mir, X., Busquets, R., Sirera, J. & Navarro-Quilis, A. (1995) Contralateral median nerve autograft. *Acta Orthop Belg*, 61, 323-6.

Matejckik, V. (2002) Peripheral nerve reconstruction by autograft. *Injury*, 33, 627-631.

Sepulveda, P., Jones, J. R. & Hench, L. L. (2001) Characterization of melt-derived 45S5 and sol-gel-derived 58S bioactive glasses. *J Biomed Mater Res*, 58, 734-40.

Standard, B. (2009a) Biological evaluation of medical devices. *Part 5: Tests for in vitro cytotoxicity (10993-5)*.

Standard, B. (2009b) Biological evaluation of medical devices. *Part 14 : Identification and quantification of degradation products from ceramics (19903-14)*.

Standardisation, I. O. F. (2000) Sample preparation. *Dispersing procedures for powders in liquids*.

Standards, I. (2006) Sterilization of health care products -- Radiation *Part 1: Requirements for development, validation and routine control of a sterilization process for medical devices*.

Stoor, P., Soderling, E. & Salonen, J. I. (1998) Antibacterial effects of a bioactive glass paste on oral microorganisms. *Acta Odontol Scand*, 56, 161-5.

X.F.Zhang, S. K., S. K. Adhi, T.G. Ajithkumar, S. Moane, D.Boyd (2010) Composition-Structure-Property ( $Zn^{2+}$  and  $Ca^{2+}$  Ion Release) Relationships in Si-Na-Ca-Zn-Ce Glasses: Potential Components for Nerve Guidance Conduits. .



# Development of a Novel Oral Vaccine Against *Mycobacterium avium* subspecies *paratuberculosis* and Johne's Disease: A Patho-biotechnological Approach

C. Johnston<sup>1</sup>, A. Coffey<sup>1</sup>, J. O' Mahony<sup>1\*</sup>, R. D. Sleator<sup>1,2</sup>

<sup>1</sup>Cork Institute of Technology, Bishopstown, Cork and <sup>2</sup>Alimentary Pharmaceutical Centre University College, Cork, Ireland.

## Abstract

The development of a novel oral subunit-vaccine against *Mycobacterium avium* subspecies *paratuberculosis* (MAP), the etiological agent of the bovine granulomatous enteritis Johne's disease, through a patho-biotechnological approach is proposed. Through bioinformatic analysis of the complete MAP genome, the initial objective was to identify a bank of MAP genes encoding potentially immunodominant antigens to be heterologously cloned and expressed by a novel vaccine delivery platform. A defined set of 25 MAP genes encoding putatively antigenic secreted, cytosolic and surface expressed proteins has been identified. Currently, the heterologous expression of these antigenic genes in a *Lb. salivarius* delivery strain, through a controlled inducible expression system, is under investigation. Once achieved, the delivery strain will be equipped with pathogenetic elements from the Gram-positive intracellular pathogen *Listeria monocytogenes* which will allow the strain access to appropriate antigen presentation pathways in order to stimulate a strong immune response and provide protection against a subsequent MAP challenge in an animal model of infection.

**Keywords:** Vaccine, Paratuberculosis, Johne's Disease, Patho-biotechnology, *Listeria monocytogenes*.

## 1. Introduction

*Mycobacterium avium* subspecies *paratuberculosis* (MAP) is a slow growing, Gram positive, acid fast, intracellular pathogenic Bacillus and the etiological agent of Johne's disease in cattle. This is a chronic untreatable granulomatous enteritis with symptoms including intestinal inflammation, poor nutrient uptake, severe diarrhoea, emaciation, and eventual death of the infected host (Chacon et al. 2004). Paratuberculosis infection has been demonstrated mainly in ruminants including

cattle, sheep, rabbits, bison and red deer (Chacon et al. 2004; Sleeman et al. 2009; Sohal et al. 2010).

Johne's disease is prevalent in cattle worldwide and as such, has a significant impact on the global economy (Harris and Barletta 2001). The U.S dairy industry alone has reported annual losses ranging from US\$ 200 million to 1.5 billion due to infection (Harris and Barletta 2001; Ott et al. 1999). These costs are mainly attributed to decreased milk production, weight loss and increased culling measures. In Ireland, substantial economic losses have also occurred consequent to the presence of Johne's disease within dairy herds (Barrett et al. 2006).

MAP contaminates and persists in water and the environment, can survive milk pasteurisation and is present in dairy and meat products from infected animals (Hermon-Taylor 2009). It is therefore inevitable that human populations are widely exposed (Hermon-Taylor 2009). An overwhelming balance of probability and Public health risk favours the conclusion that MAP is also pathogenic to humans (Hermon-Taylor 2009). It is a strong candidate pathogen in the development of Crohn's disease, a human systemic disorder involving chronic inflammation of the intestine similar to that observed in Johne's disease infected animals (Hermon-Taylor 2009; Scanu et al. 2007).

## **2. Vaccination against MAP**

There is currently no cure for Johne's disease and hygienic measures or culling procedures are not sufficient to prevent its spread (Rosseels and Huygen 2008). Moreover, the available vaccines against Johne's disease do not fully protect animals from infection, but rather reduce clinical symptoms and limit shedding of MAP in faeces (Rosseels and Huygen 2008). While several whole cell vaccines have been developed, based on heat killed or live attenuated strains of MAP, issues related to their use prevents their widespread application in control strategies (Collins 1994; Rosseels and Huygen 2008). The associated drawbacks with these vaccines include (i) the presence of local granulomatous lesions at the site of injection, (ii) interference with current serodiagnostic tests for MAP and (iii) failure to fully protect animals from subsequent exposure to MAP. Administration of vaccines developed from whole organisms also increases the likelihood of interference with bovine tuberculosis screening tests (Mackintosh et al. 2008; Nedrow et al. 2007).

Next generation animal vaccines will be complex molecular entities with multiple components tailored to generate the most potent and effective immune response. Accordingly, through comparative bioinformatic analysis of the completed MAP genome, a defined set of MAP genes encoding potentially immunodominant secreted, cytosolic and surface expressed antigens have been assembled within our laboratory. The challenge ahead is to effectively deliver these antigens in a manner that will stimulate the appropriate immune responses, a task which will require an efficient and controllable vaccine strategy. Building on the experience of previous vaccine strategies will be crucial.

Vaccine developments against other intracellular pathogens, similar to MAP, have used attenuated strains of the intracellular pathogen *L. monocytogenes* as effective vaccine carriers to the immune system (Jia et al. 2009). These strategies are based on observations that the pathogen has both a phagosomal and cytosolic phase, facilitating the stimulation of CD4+ and CD8+ immune responses respectively (Jia et al. 2009; Starks et al. 2004). The infection strategy of *L. monocytogenes* has notable similarities to that employed by MAP but despite this, its potential as a MAP vaccine carrier has not been investigated. It is likely that this is due to concerns over the use of attenuated pathogens in vaccine development which comes with the possibility of reversion to a virulent phenotype (Sleator and Hill 2008a).

Alternatively, probiotic or GRAS (Generally Regarded as Safe) bacterial strains have also been assessed for applications in vaccine delivery strategies (Pouwels et al. 1998; Shi et al. 2006). In this field however, their potential is hampered by fragility and sensitivity toward stresses associated with formulation and environmental conditions in the gut including the presence of bile, high osmolarity, low iron or acidic environments (Sleator and Hill 2007). The advent of patho-biotechnology, which exploits inherent mechanisms from pathogenic bacteria, has brought about novel strategies to improve the potential of these probiotic or GRAS strains for use in clinical, drug, and vaccine delivery applications (Sleator and Hill 2008a; Sleator and Hill 2008b).

This paper details the development of a novel oral subunit-vaccine against MAP and Johne's disease which will utilize a patho-biotechnological approach. A *Lactobacillus* strain with GRAS status, harbouring an inducible expression vector encoding immunodominant MAP antigens, is to be equipped with patho-genetic elements derived from *L. monocytogenes* which will allow the strain to access appropriate antigen presentation pathways in order to stimulate a strong immune response. After vaccination with MAP antigens *via* this novel delivery platform, levels of protective efficacy will be assessed in a murine model of infection.

### **3. Mycobacterium avium subspecies paratuberculosis (MAP)**

MAP is shed in the faeces of infected animals and can survive within the environment for up to 12 months (Whittington et al. 2004). It has been suggested that biofilms or biofilm-like structures play a role in its prolonged survival, allowing the pathogen to spread horizontally to naïve hosts via the faecal oral route (Wu et al. 2009). Infant calves with immature immune responses are also particularly susceptible to infection via contaminated milk or colostrum on farms with a high prevalence of the disease (Baptista et al. 2008).

#### 4. Immune responses to MAP and the causation of Johne's disease

The principal goal of vaccination is to prime the immune system to facilitate a more effective and rapid immune response following infection with the pathogen, therefore understanding the interactions between the pathogen and the immune system are fundamental in the development of an effective vaccine. MAP is an intracellular pathogen and therefore the cellular immune response plays a key role in its control within the host (Coussens 2001; Koets et al. 2002a).

The cellular immune response is comprised of both T helper lymphocytes (CD4+) and cytolytic T lymphocytes (CTL) or killer T lymphocytes (CD8+) (Esser et al. 2003). T helper cells are responsible for orchestrating and directing responses, whereas CTLs are the killer cells that traffic to the site of infection and lyse infected cells (Esser et al. 2003). Activated CD4+ cells can differentiate into T helper 1 (Th1) cells, which secrete proinflammatory cytokines (IFN- $\gamma$  and TNF- $\alpha$ ), or T helper 2 (Th2) cells, which secrete anti-inflammatory cytokines (IL-4, 5, 10 and 13) (Esser et al. 2003). Th1 T cells are involved in effective immune responses to intracellular pathogens by promoting microbicidal activities of macrophages. Th2 T cells promote immunoglobulin G1 (IgG1) antibody production, suppression of Th1 activity, and are likely ineffective in case of intracellular infections (Koets et al. 2002a).

Maintenance of a Th1-type immune response during the early stages of infection is vital for myco-bacteriostasis (Coussens 2001). Failure to elicit a strong enough CD8+ response to effectively clear infection results in increased tissue damage to intestinal epithelial cells (due to prolonged exposure to high levels of proinflammatory cytokines) along with an increase in bacterial loads (Coussens 2001).

#### 5. Implications for an effective MAP vaccine.

The necessity for a strong cellular Th-1 type immune response at the early stages of Johne's disease, characterised by the presence of CD4+ T lymphocytes to control, and cytolytic CD8+ T lymphocytes to effectively clear the infection, has profound implications on vaccine development. A successful vaccine will require strong stimulation of both these lymphocyte subsets to induce a sufficient immunological memory which, upon challenge with MAP, can respond quickly and efficaciously.

Another intracellular pathogen, *L. monocytogenes*, displays a pattern of concomitant killing and intracellular multiplication within murine macrophage (de Chastellier and Berche 1994). This facilitates the stimulation of both the CD4+ T cell immune response (through cell destruction within the phagosome and MHC class II antigen presentation) and the CD8+ T cell response (through multiplication within the intracytoplasmic environment and antigen presentation to the MHC class I pathway) (Chacon et al. 2004; Starks et al. 2004). Both *L. monocytogenes* and MAP stimulate the production of IFN- $\gamma$ , as well as various other proinflammatory cytokines, at an early stage of their respective infection. IFN- $\gamma$  is considered vital in the development

of Th1-dependant acquired resistance against both of these intracellular pathogens (Hara et al. 2007; Koets et al. 2002b).

Attenuated strains of *Listeria monocytogenes* have previously been assessed as vaccine delivery vehicles for other intracellular pathogens, including *Francisella tularensis* (the causative agent of Tularemia), and have shown promising results (Jia et al. 2009). Taking this into consideration, an attenuated *L. monocytogenes* strain would appear a potentially effective delivery vehicle in a vaccine strategy against MAP. Despite this potential, no research has been published indicating such a strategy. It is possible that this is due to concerns over the use of attenuated pathogens for vaccination, which comes with the ever present possibility of reversion to a virulent phenotype (Sleator and Hill 2008a).

An intriguing alternative to using attenuated pathogens has arisen from the application of a patho-biotechnological approach to vaccine development, exploiting the potential of pathogens, but through the use of probiotic or GRAS bacterial strains.

## 6. Patho-biotechnology

Patho-biotechnology is a term originally used by Sleator and Hill (Sleator and Hill 2008a) which describes the application of pathogen derived stress survival mechanisms for the design of more robust and effective probiotic cultures with improved efficacy in clinical applications, vaccine development and drug delivery platforms (Sleator and Hill 2007; Sleator and Hill 2008a).

A number of health-promoting lactic acid bacteria are currently used in clinical contexts. However, the full therapeutic potential of these probiotic bacteria is not realised as a result of their susceptibility to stresses ever present in mammalian gut such as bile, high osmolarity, low iron or acidic environments (Sleator and Hill 2007; Sleator and Hill 2008b). Conversely, pathogenic bacteria have evolved numerous virulence mechanisms which allow them to successfully invade, persist and spread throughout a host while evading its immune responses as well as surviving for prolonged periods within the environment (Sleator and Hill 2008a). Widespread access to whole genome sequences of many pathogenic and non-pathogenic bacteria has made it possible to elucidate the genetic elements which confer these mechanisms to pathogenic strains. Subsequent application of such genetic elements to fragile probiotic strains has permitted the development of recombinant or “designer” probiotics which are sturdier and have improved tolerance to stresses (Sleator and Hill 2007). At the forefront of patho-biotechnology, *L. monocytogenes* has become an important source of patho-genetic elements which are being applied to probiotic strains to improve their clinical efficacy and survival under stresses.

## 7. A patho-biotechnological approach towards developing an effective MAP vaccine

Herein, we propose the development of a novel oral probiotic vaccine platform capable of expressing immunodominant MAP antigens to subepithelial macrophage thus eliciting a strong cell mediated immune against MAP using a Patho-biotechnology based approach.

After oral ingestion the first listerial element, internalin A (*inlA*), will enable the *Lactobacillus* strain to traverse the gut wall and be engulfed by subepithelial macrophage. The second patho-genetic element, listeriolysin O (LLO), will promote escape from the phagosome and allow expression and secretion of the MAP antigens to the macrophage cytosol. While in the phagosome a certain proportion of *Lactobacillus* cells will be lysed releasing antigens for subsequent processing and presentation to the MHC class II pathway stimulating a strong CD4+ T cell response. Antigens secreted within the cytosol will be processed and presented to the MHC class I pathway for stimulation of a CD8+ T cell response. Presentation in such a manner, and the stimulation of a strong cell mediated immune response, should induce an immunological memory and provide protection against a subsequent MAP challenge in an animal model of infection. (See Fig. 2) The protective efficacy of the selected MAP antigens as well as the effectiveness of the patho-biotechnological delivery strain will be assessed in a murine model of infection.

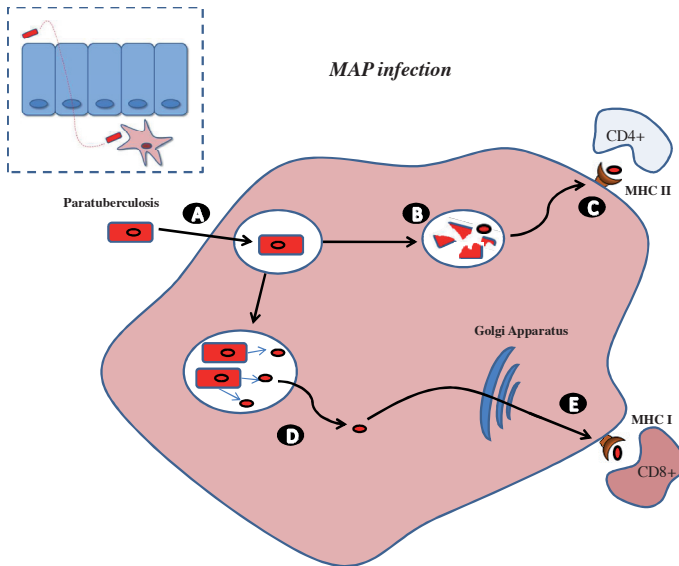
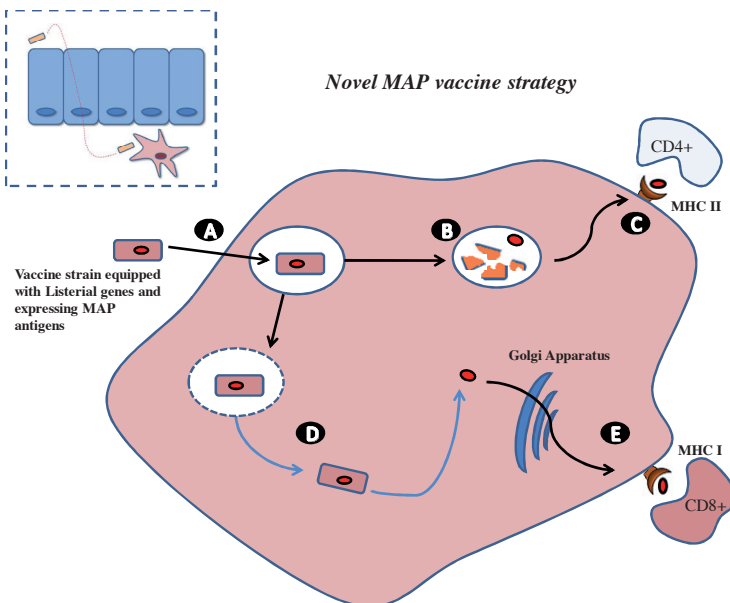


Figure 1: Mycobacterium avium paratuberculosis within macrophage

MAP infects by passing the mucosal barrier, preferentially via M cells, and after which it is engulfed by subepithelial macrophage (A). A number of MAP bacilli are degraded within the phagosome (B) and stimulate CD4+ immune responses via antigen presentation through the MHC class II pathway. (C) Alternatively MAP evades destruction within phagosome, through inhibition of normal killing mechanisms, and proliferates. (D) Secreted MAP proteins may pass from the phagosome to the cytosol and be subsequently available for presentation to CD8+ immune responses via the MHC class I pathway. Survival and proliferation within macrophage is a vital element in the virulence of paratuberculosis.



**Figure 2: Novel patho-biotechnological vaccine development against Johne's disease**

A *Lactobacillus* strain, harbouring an expression vector encoding MAP antigens, will be equipped with an internalin from *Listeria* which will allow translocation across the epithelial barrier and subsequent phagocytosis by macrophages (A). In a similar manner to *Listeria* within the phagosome, a number of lactobacilli will be lysed allowing presentation of the expressed MAP antigens via the MHC class II pathway to stimulate strong CD4+ immune responses (B-C). Heterologously expressed listeriolysin O, from *Listeria monocytogenes*, will allow the *Lactobacillus* strain to escape the phagosome. (D) Expression of MAP antigens within the macrophage cytosol will stimulate strong CD8+ immune responses through the MHC class I pathway (E).

## Acknowledgements:

The author's acknowledge the financial assistance of the Irish Government through funding by a Food Institutional Research Measure Grant.

## References

- Baptista, F. M., Nielsen, S. S., and Toft, N. (2008). "Association between the presence of antibodies to *Mycobacterium avium* subspecies paratuberculosis and somatic cell count." *Journal of Dairy Science*, 91(1), 109-118.
- Barrett, D. J., Good, M., Hayes, M., and More, S. J. (2006). "The economic impact of Johne's disease in an Irish dairy herd: A case study." *Irish Veterinary Journal*, 59(5), 282-+.
- Chacon, O., Bermudez, L. E., and Barletta, R. G. (2004). "Johne's disease, inflammatory bowel disease, and *Mycobacterium paratuberculosis*." *Annu Rev Microbiol*, 58, 329-63.
- Collins, M. T. (1994). "Clinical approach to control of bovine paratuberculosis." *J Am Vet Med Assoc*, 204(2), 208-10.
- Coussens, P. M. (2001). "Mycobacterium paratuberculosis and the bovine immune system." *Anim Health Res Rev*, 2(2), 141-61.
- de Chastellier, C., and Berche, P. (1994). "Fate of *Listeria monocytogenes* in murine macrophages: evidence for simultaneous killing and survival of intracellular bacteria." *Infect Immun*, 62(2), 543-53.
- Esser, M. T., Marchese, R. D., Kierstead, L. S., Tussey, L. G., Wang, F., Chirmule, N., and Washabaugh, M. W. (2003). "Memory T cells and vaccines." *Vaccine*, 21(5-6), 419-30.
- Hara, H., Kawamura, I., Nomura, T., Tominaga, T., Tsuchiya, K., and Mitsuyama, M. (2007). "Cytolysin-dependent escape of the bacterium from the phagosome is required but not sufficient for induction of the Th1 immune response against *Listeria monocytogenes* infection: distinct role of Listeriolysin O determined by cytolysin gene replacement." *Infect Immun*, 75(8), 3791-801.
- Harris, N. B., and Barletta, R. G. (2001). "Mycobacterium avium subsp. paratuberculosis in Veterinary Medicine." *Clin Microbiol Rev*, 14(3), 489-512.
- Hermon-Taylor, J. (2009). "Mycobacterium avium subspecies paratuberculosis, Crohn's disease and the Doomsday scenario."



*Gut Pathog*, 1(1), 15.

Jia, Q., Lee, B. Y., Clemens, D. L., Bowen, R. A., and Horwitz, M. A. (2009). "Recombinant attenuated *Listeria monocytogenes* vaccine expressing *Francisella tularensis* IgIC induces protection in mice against aerosolized Type A *F. tularensis*." *Vaccine*, 27(8), 1216-29.

Koets, A., Rutten, V., Hoek, A., van Mil, F., Muller, K., Bakker, D., Gruys, E., and van Eden, W. (2002a). "Progressive bovine paratuberculosis is associated with local loss of CD4(+) T cells, increased frequency of gamma delta T cells, and related changes in T-cell function." *Infect Immun*, 70(7), 3856-64.

Koets, A., Rutten, V., Hoek, A., van Mil, F., Muller, K., Bakker, D., Gruys, E., and van Eden, W. (2002b). "Progressive bovine paratuberculosis is associated with local loss of CD4(+) T cells, increased frequency of gamma delta T cells, and related changes in T-cell function." *Infection and Immunity*, 70(7), 3856-3864.

Mackintosh, C. G., Labes, R. E., Thompson, B. R., Clark, R. G., de Lisle, G. W., Johnstone, P. D., and Griffin, J. F. (2008). "Efficacy, immune responses and side-effects of vaccines against Johne's disease in young red deer (*Cervus elaphus*) experimentally challenged with *Mycobacterium avium* subsp paratuberculosis." *N Z Vet J*, 56(1), 1-9.

Nedrow, A. J., Gavalchin, J., Smith, M. C., Stehman, S. M., Maul, J. K., McDonough, S. P., and Thonney, M. L. (2007). "Antibody and skin-test responses of sheep vaccinated against Johne's Disease." *Vet Immunol Immunopathol*, 116(1-2), 109-12.

Ott, S. L., Wells, S. J., and Wagner, B. A. (1999). "Herd-level economic losses associated with Johne's disease on US dairy operations." *Prev Vet Med*, 40(3-4), 179-92.

Pouwels, P. H., Leer, R. J., Shaw, M., den Bak-Glashouwer, M. J. H., Tielen, F. D., Smit, E., Martinez, B., Jore, J., and Conway, P. L. (1998). "Lactic acid bacteria as antigen delivery vehicles for oral immunization purposes." *International Journal of Food Microbiology*, 41(2), 155-167.

Rosseels, V., and Huygen, K. (2008). "Vaccination against paratuberculosis." *Expert Rev Vaccines*, 7(6), 817-32.

Scanu, A. M., Bull, T. J., Cannas, S., Sanderson, J. D., Sechi, L. A., Dettori, G., Zanetti, S., and Hermon-Taylor, J. (2007). "Mycobacterium avium subspecies paratuberculosis infection in cases of irritable bowel syndrome and comparison with Crohn's disease and Johne's disease: common neural and immune pathogenicities." *J Clin Microbiol*, 45(12), 3883-90.

- Shi, D., Song, Y., and Li, Y. J. (2006). "[Progress on lactococcus lactis expressing heterologous antigens as live mucosal vaccines]." *Wei Sheng Wu Xue Bao*, 46(4), 680-3.
- Sleator, R. D., and Hill, C. (2007). "Improving probiotic function using a pathobiotechnology approach." *Gene Ther Mol Biol*, 11, 269-274.
- Sleator, R. D., and Hill, C. (2008a). "'Bioengineered Bugs' - A patho-biotechnology approach to probiotic research and applications." *Medical Hypotheses*, 70(1), 167-169.
- Sleator, R. D., and Hill, C. (2008b). "New frontiers in probiotic research." *Lett Appl Microbiol*, 46(2), 143-7.
- Sleman, J. M., Manning, E. J., Rohm, J. H., Sims, J. P., Sanchez, S., Gerhold, R. W., and Keel, M. K. (2009). "John's disease in a free-ranging white-tailed deer from Virginia and subsequent surveillance for *Mycobacterium avium* subspecies paratuberculosis." *J Wildl Dis*, 45(1), 201-6.
- Sohal, J. S., Singh, S. V., Singh, P. K., and Singh, A. V. (2010). "On the evolution of 'Indian Bison type' strains of *Mycobacterium avium* subspecies paratuberculosis." *Microbiol Res*, 165(2), 163-71.
- Starks, H., Bruhn, K. W., Shen, H., Barry, R. A., Dubensky, T. W., Brockstedt, D., Hinrichs, D. J., Higgins, D. E., Miller, J. F., Giedlin, M., and Bouwer, H. G. A. (2004). "Listeria monocytogenes as a vaccine vector: Virulence attenuation or existing antivector immunity does not diminish therapeutic efficacy." *Journal of Immunology*, 173(1), 420-427.
- Whittington, R. J., Marshall, D. J., Nicholls, P. J., Marsh, I. B., and Reddacliff, L. A. (2004). "Survival and dormancy of *Mycobacterium avium* subsp. paratuberculosis in the environment." *Appl Environ Microbiol*, 70(5), 2989-3004.
- Wu, C. W., Schmolter, S. K., Bannantine, J. P., Eckstein, T. M., Inamine, J. M., Livesey, M., Albrecht, R., and Talaat, A. M. (2009). "A novel cell wall lipopeptide is important for biofilm formation and pathogenicity of *Mycobacterium avium* subspecies paratuberculosis." *Microbial Pathogenesis*, 46(4), 222-230.

# ***In silico* Identification of the Principle Osmotic Stress Response Mechanisms of *Cronobacter sakazakii***

Feeney A and Sleator RD

Department of Biological Sciences, Cork Institute of Technology, Rossa Avenue, Bishopstown, Cork, Ireland.

E-mail: roy.sleator@cit.ie

## **Abstract**

Up to 80% of infants infected with *Cronobacter sakazakii* die within days of birth making this emerging pathogen a serious cause for concern. Necrotising enterocolitis, meningitis and septicemia are among the most common symptoms of infection, with low weight neonates most at risk. The mode of transmission associated with *Cronobacter sakazakii* infection is powdered infant formula (PIF), which typically has a water activity (aw) of ca 0.2. A comparative genomic approach was used to investigate the unique ability of this organism to survive and persist at such a low aw. A comprehensive review of the mechanisms involved in bacterial osmoadaptation was carried out. Homology-based searches were performed to identify sequence similarities between genes known to confer osmotolerance and the recently published *Cronobacter sakazakii* complete genome sequence.

## **Keywords**

*Cronobacter sakazakii*, osmotolerance, *In silico*

## **1. Introduction**

A characteristic feature of the emerging foodbourn pathogen *Cronobacter sakazakii* is its ability to survive and persist in adverse environmental conditions, most notably desiccation and osmotic stress (Barron and Forsythe 2007). Survival in powdered infant formula (PIF), which typically has an aw of ca 0.2, has been demonstrated for a period of up to 2.5 years (Barron and Forsythe 2007, Breeuwer et al 2003). This adaptation coupled with the fact that up to 80% of infants infected with *Cronobacter sakazakii* die within days of birth, from symptoms such as necrotizing enterocolitis, meningitis and septicemia, have made this organism a serious cause for concern (Nazarowec-White and Farber 1997, Aker et al 2000). However as yet little is known about the molecular mechanisms by which *Cronobacter sakazakii* adapts to survive in environments with such a low water activity. This dearth of information may be as a result of the relatively low but increasing frequency of outbreaks, the lack of bioinformatics tools available for such genetic investigations and the fact that the complete genome sequence was not available until recently (Kucerova et al 2010).

In the case of desiccation, which can be seen as an extreme form of osmotic stress, the cells must preserve their biological integrity in the absence of water (Potts 1994, Breeuwer et al 2003). Early physiological analysis has revealed that the adaptation of microbial cells to variations in osmolarity is attributed to a variety of

osmopressure response mechanisms which involve the accumulation of ions and low molecular weight molecules, called osmolytes or compatible solutes (Sleator et al 2003, Sleator and Hill 2001). Cytoplasmic hydration is maintained effectively with the accumulation of these osmoprotectants when medium osmolality is high and efflux of these molecules when medium osmolality drops (Wood et al 2001). Following the recent publication of the *Cronobacter sakazakii* genome it will be possible for the first time to perform a comparative in silico investigation to identify the genes involved in the adaptation of this organism to alterations in the external osmolarity. The wealth of physiological and molecular data available on the osmotic stress response mechanisms of *E. coli* and *L. monocytogenes* make them ideal model organisms for comparison during this study.

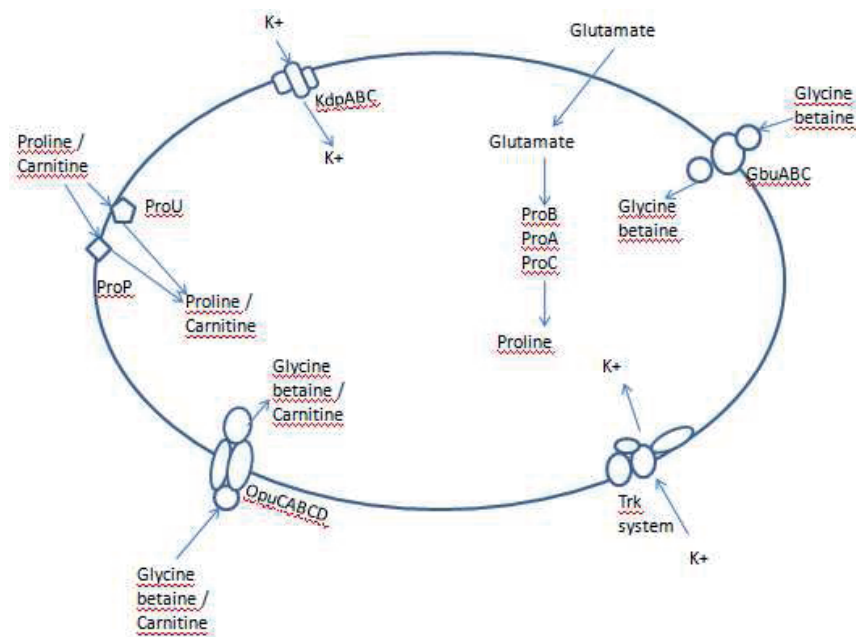
Herein we outline a comprehensive review of the mechanisms involved in bacterial osmoadaptation to develop our understanding of the molecular responses of bacteria to variations in the external osmolality. Homology-based searches identify sequence similarities between genes known to confer osmotolerance in the model organisms and the recently published *Cronobacter sakazakii* complete genome sequence.

## 2. Background

*Cronobacter* spp, a member of the Enterobacteriaceae family, are motile, non spore forming, Gram negative facultative anaerobes which are catalase positive and oxidase negative (Inversen et al 2004, Inversen et al 2007, Lehner et al 2006, Nazarowec-White and Farber 1997). Previously referred to as "yellow pigmented *Enterobacter cloacae*", the bacterium was classified as *Enterobacter sakazakii* in 1980 when Farmer et al identified differences between *Enterobacter cloacae* and *Enterobacter sakazakii* based on deoxy ribonucleic (DNA)-DNA hybridization, biochemical reactions, pigment production and antibiotic susceptibility (Farmer et al 1980). However, recent developments in genetic and molecular techniques led Iversen et al (2007) to propose that the original taxonomy of *E. sakazakii* was incorrect, based on f-ALP fingerprinting, ribopatterns and full length 16S rRNA gene sequencing, and thus reclassification of the organism was necessary. The existence of divergent biogroups suggested that the original species, *E. sakazakii*, in fact represented multiple species comprising of five novel genomospecies (*C. sakazakii*, *C. malonaticus*, *C. turicensis*, *C. muytjensii*, *C. dublinensis*) within a novel genus named *Cronobacter* (Iversen et al 2008).

To date the source of *C. sakazakii* remains unclear, however contaminated powdered infant formula (PIF) has been epidemiologically linked with several recent outbreaks of *C. sakazakii* infection in infants (Biering et al 1989, Iversen and Forsythe 2003, Iversen and Forsythe 2004, Healy et al 2010, Breeuwer et al 2003, Ye et al 2008). Recovery of *C. sakazakii* from PIF was reported in 3-14% of samples analysed by Iversen and Forsythe (2006), however reported levels did not exceed 1 CFU/g. Thus, although present at low levels, survival for extended periods in PIF has been demonstrated with some capsulated strains surviving for up to 2.5 years (Barron and Forsythe 2007). Furthermore, given that pasteurisation effectively inactivates *C. sakazakii*, the presence of the pathogen in PIF is mainly attributed to post-processing environmental contamination such as the addition of contaminated ingredients and the use of non-sterile equipment (Al-Nabulsi et al 2009).

Mortality rates of 40-80% in infected infants are a serious cause for concern (Ray et al 2007). Low weight neonates are most at risk, with the incidence rate for infection increasing from 2-5% in premature infants to 13% in those weighing less than 1.5 kg at birth (Iversen and Forsythe 2003). In many cases neonates infected with *C. sakazakii* die within days of birth (Nazarowec-White and Farber 1997). Survivors on the other hand often suffer severe neurological sequelae such as hydrocephalus, quadriplegia and retarded neural development (Forsythe 2005, Amalaradjou et al 2008).



**Figure 1: Cronobacter sakazakii osmotic stress responses based on the in-silico analysis of the organisms genome.**

### 3. Molecular characterisation of the genes involved in the primary response of Cronobacter sakazakii to hyperosmotic stress

*In silico* analysis of *C. sakazakii* osmotolerance mechanisms

A comparative genomic approach was used to identify the key osmotolerance loci of the emerging pathogen *C. sakazakii*. Two of the best studied bacterial pathogens, in terms of osmotolerance, *L. monocytogenes* and *E. coli* were used as model organisms to facilitate computational analysis and homologue searches.

*In silico* analysis was applied using the Basic Local Alignment Search Tool (BLAST) of the National Centre for Biotechnology Information (NCBI). All variants of the BLAST algorithm (BLASTN, TBLASTN, BLASTX, TBLASTX, BLASTP) were used to gain a comprehensive insight into the presence of specific osmotolerance genes in the *C. sakazakii* genome. Genes from *E. coli* and *L. monocytogenes* previously identified as having a particular role in osmotolerance

were screened against the *C. sakazakii* complete genome and comparisons made were based on the scoring parameters. A cut off point of 20% identity was used which also identified gene homologies within the twilight zone of sequence identity ( $\approx 25\%$ ). BLOSUM and PAM upper and lower scoring matrices were used in addition to the default BLOSUM 62 scoring matrix. Sequences with a similarity of  $\geq 50\%$  were considered homologous.

The Editseq algorithm of the DNASTAR suite of applications was used to translate the nucleotide sequence of an osmotolerance gene into a protein sequence for further analysis using the BLASTP programme to identify homologous proteins in the proteomes of the *Cronobacter* genus. Position specific iterated (Psi)-BLAST was used to find distantly related proteins using a position-specific scoring matrix (PSSM or profile) in which the profile becomes the query sequence in the subsequent BLAST searches.

### Primary Response

The primary response of bacterial cells to an osmotic upshift in the external environment at the molecular level involves the activation of transporters, to facilitate the rapid accumulation of osmoprotectants, and sensor kinases, to increase the transport and/or biosynthesis of osmoprotectants (Poolman et al 2002). The rapid accumulation of high concentrations of potassium and its counter ion glutamate acts as a temporary osmo-protectant during hyperosmotic conditions and facilitates the uptake and *de nova* synthesis of other osmoprotectants (Gralla and Vargas 2006). *E. coli* possess two low affinity  $K^+$  transport systems, Trk and Kup, and an inducible high affinity  $K^+$  specific transport system, the Kdp system (Alahari et al 2001). A comparative genomic approach based on homology searches screened the *Cronobacter sakazakii* complete genome sequence for potassium transporters and homologues to the high and low affinity potassium transporters of *E. coli* were identified on the genome.

*Trk*: The Trk system has been attributed as being quantitatively the most important system for  $K^+$  accumulation in the initial phase of hyper-osmotic stress (Poolman and Glaasker 1998). The system is made up of two low affinity, high capacity, membrane bound  $K^+$  transporters, TrkG and TrkH, which are constitutively expressed in *E. coli* (Sleator and Hill 2001, Ly et al 2003). A high trans-membrane proton-motive force in addition to a high level of cytoplasmic ATP are required for  $K^+$  uptake via the Trk system (Bakker 1983). Although ATP was once believed to drive  $K^+$  uptake (Epstein and Laimins 1980) it is now known to activate TrkA, a peripheral membrane protein which regulates TrkG and TrkH (Bossemeyer et al 1989). Similarly TrkE represents a regulatory domain essential to the function of TrkH, however TrkG functions in the absence of TrkE (Nakamura et al 1998). The rate of influx of  $K^+$  via the Trk system is dependent on the intracellular osmolality at the time of the external osmotic increase (Poolman and Glaasker 1998). TrkG and TrkH have respective  $K_m$  and  $V_{max}$  values of 0.3-1 mM and 2.2-3.0 mM and  $>200 \text{ nmol min}^{-1} (\text{mg protein})^{-1}$  and  $>300 \text{ nmol min}^{-1} (\text{mg protein})^{-1}$  (Sleator and Hill 2001). We have identified a homologous region to the *E. coli* Trk system on the *Cronobacter sakazakii* genome between amino acid positions 1 and 483 suggesting that this organism uses a similar system for adaptation to hyper-osmotic stress.

*Kup*: Kup (also referred to as TrkD) is similar to the Trk system in that it is a constitutively expressed, low affinity  $K^+$  uptake protein present in *E. coli*

(Schleyer and Bakker 1993). However at a low pH (below 6.0) the activity of the Trk system is reduced and Kup becomes the major K<sup>+</sup> uptake protein (Trchounian and Kobayashi 1999). *K<sub>m</sub>* and *V<sub>max</sub>* values of 0.58mM and 0.10  $\mu\text{mol K}^+/\text{min}/\text{mg}$  protein respectively have been reported for K<sup>+</sup> uptake with Kup at a pH of 5.5 (Trchounian and Kobayashi 1999). It is however unlikely that Kup plays a role in the osmoadaptation of *E. coli* to hyper-osmotic shock (Schleyer et al 1993). This study found a homologous region on the *Cronobacter sakazakii* genome with 91% sequence identity to the Kup system found in *E. coli* (Table 1).

*Kdp*: The Kdp system is an inducible P-type ATPase which has a high affinity and specificity for K<sup>+</sup> (Roe et al 2000). *K<sub>m</sub>* and *V<sub>max</sub>* values for K<sup>+</sup> uptake via the Kdp system were measured at 2  $\mu\text{M}$  and 150  $\mu\text{mol}/\text{g min}$ , respectively (Rhoads et al 1976). Kdp is a four protein system (KdpFABC) encoded by the *kdpFABC* operon (Roe et al 2000, Sharfstein et al 2007). Adjacent and overlapping the *kdpC* gene is the *kdpDE* operon which forms a dual component regulatory system encoding a sensor kinase protein (KdpD) and a soluble transcriptional activator (KdpE) (Sleator and Hill 2001, Sardesai and Gowrishankar 2000, Gaßel and Altendorf 2001). The promoter for the *kdpDE* operon lies within *kdpC* however since there is an overlap between the *kdpDE* and *kdpC* read through at the level of transcription also occurs (Voelkner et al 1993, Polarek et al 1992).

### Secondary Response

High concentrations of potassium and its counter ion glutamate has the capacity to disturb cellular metabolism making the secondary response the preferred option for long term protection against hyperosmotic stress (Gralla and Vargas 2006). The secondary response of most gram negative bacteria is triggered at a salt concentration of approximately 0.5 M NaCl facilitating the uptake and/or biosynthesis of neutral compatible solutes which can be accumulated to high intracellular concentrations without adversely affecting the biological processes within the cell (Sleator and Hill 2002, Galinski 1995). Compatible solutes comprise a variety of structural groups which include amino acids (e.g. glutamate, proline), amino acid derivatives (e.g. peptides, N-acetylated amino acids), quaternary amines (glycine betaine, carnitine), sugars (sucrose, trehalose) and tetrahydropyrimidines (ectoines) (Poolman and Glaasker 1998, Wood et al 2001). Although the list of compatible solutes is extensive and varied this study has found that *Cronobacter sakazakii* contains the genes to transport and/or synthesis many of these compounds. In particular glycine betaine, proline and carnitine have long been identified as having significant osmoprotectant qualities (Breumer et al 1994) and have also been identified as playing an important role in the osmoprotection of *Cronobacter sakazakii*.

Glycine Betaine. Prior to the development of recent sophisticated molecular methods, physiological analysis attributed glycine betaine uptake in *Listeria* to a single secondary transport system (Patchett et al 1994, Sleator and Hill 2001). However molecular analysis has identified three transport systems essential for the uptake of this compatible solute namely the BetL, OpuC and Gbu transport systems (Wemekamp-Kamphuis et al 2002).

The first of these transporters, BetL, homologous to OpuD of *Bacillus subtilis*, is a 55kDa protein with 12 transmembrane regions and is highly specific for glycine betaine with *K<sub>m</sub>* and *V<sub>max</sub>* values of 7.9 $\mu\text{M}$  and 134  $\text{nmol min}^{-1}$ , respectively (Wemekamp-Kamphuis et al 2002, Sleator et al 1999, Sleator and Hill

2001). In addition this betaine porter requires  $\text{Na}^+$  and a proton or sodium gradient for activity (Mendum and Smith 2002). Sleator et al (1999) first identified the betL gene by functional complementation of the betaine uptake mutant *E. coli* MKH13 and in addition demonstrated that disruption of the betL gene led to a significant decrease in the accumulation of glycine betaine by *L. monocytogenes* grown in the presence or absence of NaCl. Interestingly, a search for homologues to Listerial BetL on the *Cronobacter sakazakii* genome identified a choline transporter and not a betaine transporter, presumably because choline and betaine are very similar structurally. Therefore it was not surprising that these transport proteins showed similarities (40% identity) when genetic in silico analysis was carried out.

In contrast to BetL, the two remaining glycine betaine transporters, OpuC and Gbu, are members of the ATP-binding cassette superfamily and osmolyte uptake is largely dependent on ATP hydrolysis (Wemekamp-Kamphuis et al 2002). The Gbu secondary transport system is encoded by gbuABC, where gbuA encodes an ATPase, gbuB encodes a permease and gbuC encodes a substrate binding protein (Wemekamp-Kamphuis et al 2002). Moreover the gbu transport system is responsible for cold activated uptake of glycine betaine in *L. monocytogenes* in addition to the uptake of this osmolyte during osmotic stress making it a valuable system for survival in various hostile environments (Mendum and Smith 2002). An extensive range of compatible solutes, in addition to glycine betaine, are accepted by OpuC including ectoine, crotonobetaine, Q-butyrobetaine, carnitine, choline-O-sulphate, choline and proline betaine (Kempf and Bremer 1998, Sleator and Hill 2001).

The capacity of many bacterial cells to convert other compatible solutes (e.g. choline and carnitine) to betaine is an adaptation which may compensate for the fact that *de novo* synthesis of betaine is not possible for the vast majority of bacteria (Sleator and Hill 2001). *E. coli* cells transport choline into the cell via the high and low affinity transporters BefT and ProU, respectively (Sleator and Hill 2001). The betA gene encoding a choline dehydrogenase is responsible for the oxidation of choline to glycine betaine aldehyde and this is further oxidised by BetB a betaine aldehyde dehydrogenase converting glycine betaine aldehyde to glycine betaine (Lamark et al 1991). It is worth noting that although this study did not identify a betaine transporter on the *Cronobacter sakazakii* genome similar to the BetL transporter of *L. monocytogenes*, choline and carnitine transporters in addition to dehydrogenase enzymes, similar to those encoded by betA and betB, were identified. This suggests that *Cronobacter sakazakii* most likely converts other osmolytes to betaine for protection in hyperosmotic conditions.

**Proline.** The osmotically regulated proU and proP genes of *E. coli* encode transmembrane transport proteins with a high affinity for proline (Cayley et al 1992). However the majority of organisms synthesise proline from glutamate in a four step catalyzation reaction which involves the proB, proA and proC genes encoding a gamma-glutamyl kinase,  $\gamma$ -glutamyl phosphate reductase and  $\Delta^1$ -pyrroline-5-carboxylate reductase, respectively (Sleator et al 2001). The proB and proA genes generally constitute the operon which is in a different location to the proC gene on the chromosome (Sleator et al 2001). The proline pool of *E. coli* K12 cells increase 2 fold when 0.55M NaCl was added during growth in a defined salt medium (Milner et al 1987).



Carnitine. The trimethyl amino acid carnitine was first identified as a compatible solute when Kets et al (1994) discovered that carnitine from beef extract allowed *Lactobacillus plantarum* cells to grow when the sodium chloride concentration in the surrounding media was increased from 0.5M NaCl to 1.0M NaCl (Kets et al 1994). For the vast amount of bacteria carnitine is transported rather than synthesised by a range of specific and non specific transporters (Sleator and Hill 2001). Although originally found to transport proline ProP and ProU also play a role in transporting carnitine (Sleator and Hill 2001). In addition both the Gbu and OpuC transport systems can accumulate carnitine however the Gbu porter can accumulate carnitine in higher quantities and much more rapidly than OpuC (Mendum and Smith 2002). The Gbu system, although the primary system for glycine betaine uptake, was therefore identified as a secondary uptake system for carnitine (Mendum and Smith 2002).

Trehalose: In the absence of compatible solutes such as glycine betaine and proline in the external media the disaccharide trehalose becomes the primary endogenous compatible solute accumulated by de novo synthesis in *E. coli* and *S. Typhimurium* cells (Kempf and Bremer 1998). Physiological analysis previously linked the dry resistance of *Cronobacter sakazakii* with trehalose accumulation when Breeuwer et al (2003) demonstrated that the trehalose concentration in dried stationary cells increased more than five fold when compared with dried stationary phase *E. coli* and dried exponential phase *C. sakazakii*, both of which are significantly more sensitive to dry stress (Breeuwer et al 2003). However as yet there is a lack of genetic analysis to further examine the genes involved in the osmoprotective qualities of trehalose in this organism. We have identified on the *Cronobacter sakazakii* genome two genes, *otsA* (85 % identity) and *otsB* (60 % identity), encoding polypeptides of 474 and 266 amino acids which facilitate trehalose biosynthesis in *E. coli*, respectively (Kempf and Bremer 1998). The activation of the *otsA* gene is triggered by the accumulation of K<sup>+</sup> glutamate during the primary response to an osmotic upshock (Kempf and Bremer 1998, Strom and Kassen 1993). This in turn results in the protein expression of the *otsAB* operon encoding the enzymes trehalose-6-phosphate synthase and trehalose-6-phosphate-phosphatase for trehalose synthesis (Joseph et al 2010).

#### **4. Hypoosmotic stress genes identified in the *Cronobacter sakazakii* genome**

The intracellular pressure of bacterial cells increases following an influx of water during an osmotic downshift and lyses of the cell may be the result (Sukharev 2002). However bacteria manage this event via stretch activated channels on the cytoplasmic membrane, known as mechanosensitive channels, which are sensitive to mechanical disturbances in the lipid bilayer (Sukharev 2002, Pivetti 2003). First identified by Martinac et al (1987), these transporters act as safety valves to allow the efflux of large amounts of osmolytes during a sudden osmotic downshift (Sukharev 2002, Storz and Hengge-Aronis 2000). Genetic analysis has revealed four predominant mechanosensitive channels in *E. coli*: MscL, a large conductance mechanosensitive channel, MscS, a small conductance mechanosensitive channel, MscK (also known as KefA), a potassium dependant mechanosensitive channel and MscM, a mechanosensitive channel of miniconductance (Schumann et al 2010). We

have identified genes for all four mechanosensitive channels on the *Cronobacter sakazakii* genome suggesting that this organism uses a very similar method of adapting to hypoosmotic stress. However a sequence identity of 23% (within the twilight region of sequence identity) was obtained for MscM suggesting that further functional screening is required.

Aquaporins have been identified as playing essential physiological roles in the plant and animal kingdoms however their role in micro-organisms is significant for the prevention of cell lysis during an osmotic downshift (Calamita 2000). The AqpZ of *E. coli* and the AQY1 of *Saccharomyces cerevisiae* were the first identified aquaporins in microbial cells (Calamita et al 2000, Calamita et al 1995). We have identified a homologous region on the *Cronobacter sakazakii* genome with 80% identity to the AqpZ aquaporin of *E. coli*, suggesting that *Cronobacter sakazakii* uses a similar efflux system during hypoosmotic stress.

## 5. Conclusion

The lack of knowledge and severity of diseases caused by *C. sakazakii* has made this foodbourn pathogen one of significant concern. The organisms ability to survive and persist in PIF for extended periods poses a threat to neonates, infants and immunocompromised individuals. This adaptation is believed to be as a result of the principle osmotic stress response genes outlined in this study. In silico analysis on the entire genome was made possible with the recent publication of the *C. sakazakii* genome. We have identified over thirty genes from the model organisms that are believed to be important in the osmotic stress response mechanisms of *C. sakazakii*. In particular homologues to the primary K<sup>+</sup> uptake genes of *E. coli* were identified in addition to the principle compatible solute uptake genes of both *L. monocytogenes* and *E. coli*. Interestingly we did not find a BetL homologue on the *C. sakazakii* genome. In contrast a choline transporter was identified when the *C. sakazakii* genome was screened for the BetL betaine transporter, presumably because choline and betaine are very similar structurally.

## References

- Alahari A, Ballal A and Apte SK, 2001, Regulation of Potassium-Dependent Kdp-ATPase Expression in the Nitrogen-Fixing Cyanobacterium *Anabaena torulosa*, *Journal of Bacteriology*, 183 (19) 5778-5781
- Al-Nabulsi AA, Osaili TM, Al-Holy MA, Shaker RR et al, 2009, Influence of desiccation on the sensitivity of *Cronobacter* spp. to lactoferrin or nisin in broth and powdered infant formula, *International Journal of Food Microbiology*, 136 (2) 221-226
- Amalaradjou MAR, Hoagland TA and Venkitanarayanan K, 2008, Inactivation of *Enterobacter sakazakii* in reconstituted infant formula by trans-cinnamaldehyde, *International Journal of Food Microbiology*, 129 (2)146-149
- Bakker EP, 1983, pH-dependent transport of rubidium by the constitutive potassium uptake system TrkA of *Escherichia coli* K-12, *FEMS Microbiology Letters*, 16(2-3) 229-223

- Barron JC and Forsythe SJ 2007, Dry stress and survival time of *Enterobacter sakazakii* and *Enterobacteriaceae* in dehydrated powdered infant formula, *Journal of Food Protection* 70 (9) 2111-2117
- Biering G, Karlsson S, Clark NC, Jonsdottir KE, Ludvigsson P and Steingrimsdottir O, 1989, Three cases of neonatal meningitis caused by *Enterobacter sakazakii* in powdered milk, *Journal of Clinical Microbiology*, 27 (9) 2054-2056
- Bossemeyer D, Borchard A, Doschll D, Helmerll GC et al, 1989, K<sup>+</sup> transport Protein TrkA of *Escherichia coli* Is a Peripheral Membrane Protein That Requires Other Trk Gene Products for Attachment to the Cytoplasmic Membrane, *The Journal of Biological Chemistry*, 264 (28) 16403-16410
- Breumer RR, Giffel T, Cox MC, Rombouts F.M. and Abee T, 1994, Effect of exogenous proline, betaine, and carnitine on growth of *Listeria monocytogenes* in a minimal medium, *Applied Environmental Microbiology*, 60 (4) 1359-1363
- Breeuwer P, Lardeau A, Peterz M and Joosten H M, 2003, Desiccation and heat tolerance of *Enterobacter sakazakii*, 95(5) 967-973
- Calamita G, 2000, The *E. coli* aquaporin-Z water channel, *Molecular Microbiology*, 37 (2) 254-262
- Calamita G, Bishai WR, Preston GM, Guggino WB and Agre P, 1995, Molecular cloning and characterization of Aqpz a water channel from *E. coli*, *The American Society for Biochemistry and Molecular Biology*, 270 (49) 29063-29066
- Cayley S, Lewis BA and Record MT JR, 1992, Origins of the Osmoprotective Properties of Betaine and Proline in *Escherichia coli* K-12, *Journal of Bacteriology*, 174 (5) 1586-1595
- Epstein W and Laimins L, 1980, Potassium transport in *Escherichia coli*: diverse systems with common control by osmotic forces, *Trend in Biochemical Sciences*, 5(1) 21-23
- Farmer JJ, Asbury MA, Hickman FW and Brenner DJ, The *Enterobacteriaceae* Study Group, 1980, *Enterobacter sakazakii*: A New Species of “*Enterobacteriaceae*” Isolated from Clinical Specimens, *International Journal of Systemic Bacteriology*, 30 (3) 569-584
- Forsythe SJ, 2005, *Enterobacter sakazakii* and other bacteria in powdered infant formula, *Maternal and Child Nutrition*, 1 (1) 44-50
- Galinski EA, 1995, Osmoadaptation in Bacteria, *Advances in Microbial Physiology*, 37 273-328
- Gaßel M and Altendorf K, 2001, Analysis of KdpC of the K1-transporting KdpFABC complex of *Escherichia coli*, *European Journal of Biochemistry*, 268 1772-1781
- Gralla JD and Vargas DR, 2006, Potassium glutamate as a transcriptional inhibitor during bacterial osmoregulation, *The EMBO Journal*, 25 (7) 1515-1521
- Healy B, Cooney S, O’Brien S, Iversen C et al 2010, *Chronobacter* (*Enterobacter sakazakii*): An opportunistic foodborne pathogen, *Foodborne Pathogens and Disease* 7(4) 339-350
- Iversen C, and Forsythe SJ, 2003, Risk profile of *Enterobacter sakazakii*,

an emergent pathogen associated with infant milk formula. *Trends Food Science and Technology*, 14 (11) 443–454

Iversen C and Forsythe SJ, 2004, Isolation of *Enterobacter sakazakii* and other Enterobacteriaceae from powdered infant formula milk and related products, *Food Microbiology*, 21(6) 771-777

Iversen C and Forsythe SJ, 2006, Comparison of media for the isolation of *Enterobacter sakazakii*, *Applied and Environmental Microbiology*, 73(1) 48-52

Joseph TC, Rajan LA, Thampuran N, and James R, 2010, Functional Characterization of Trehalose Biosynthesis Genes from *E. coli*: An Osmolyte Involved in Stress Tolerance, *Molecular Biotechnology*, 46 (1) 20-25

Kempf B and Bremer E, 1998, Uptake and synthesis of compatible solutes as microbial stress responses to high-osmolality environments, *Arch Microbiol* 170 (5) 319-330

Kucerova E, Clifton SW, Xia XQ, Long F et al, 2010, Genome sequence of *Cronobacter sakazakii* BAA-894 and comparative genomic hybridization analysis with other *Cronobacteria* species, *Plos One* 5(3) e9556

Ly A, Henderson J, Lu A, Culham DE, and Wood JM, 2004, Osmoregulatory Systems of *Escherichia coli*: Identification of Betaine-Carnitine-Choline Transporter Family Member BetU and Distributions of betU and trkG among Pathogenic and Nonpathogenic Isolates, *Journal of Bacteriology*, 186(2) 296-306

Milner JL, McClellan DJ and Wood JM, 1987, Factors Reducing and Promoting the Effectiveness of Proline as an Osmoprotectant in *Escherichia coli* K12, *Journal of General Microbiology*, 133 (7) 1851-1860

Nakamura T, Yamamuro N, Stumpe S, Unemoto T and Bakke EP, 1998, Cloning of the trkAH gene cluster and characterization of the Trk K<sup>+</sup>-uptake system of *Vibrio alginolyticus*, *Microbiology*, 144(8) 2281-2289

Nazarowec-White M and Farber JM, 1996, *Enterobacter sakazakii*: a review, *International Journal of Food Microbiology*, 34 (2) 103-113

Patchett RA, Kelly AF, and Kroll RG, 1994, Transport of glycine betaine by *Listeria monocytogenes*, *Archives of Microbiology*, 162 (3) 205-210

Polarek JW, Williams G, and Epstein W, 1992, The Products of the kdpDE Operon Are Required for Expression of the Kdp ATPase of *Escherichia coli*, *The Journal of Bacteriology*, 174 (7) 2145-2151

Poolman B, Blount P, Folgering JHA, Friesen RHA, Moe PC and van der Heide T, 2002, How do membrane proteins sense water stress, 44 (4) 889-902

Poolman B and Glaasker E, 1998, Regulation of compatible solute accumulation in bacteria, *Molecular Microbiology*, 29 (2), 397-407

Potts M, 1994, Desiccation tolerance of prokaryotes, *Microbiological Reviews*, 58 (4) 755–805.

- Ray P, Das A, Gautam V, Jain N, Narang A and Sharma M, 2007, *Enterobacter sakazakii* in infants: novel phenomenon in India, *Indian Journal of Medical Microbiology*, 25 (4) 408-410
- Rhoads DB, Waters FB, and Epstein W, 1976, Cation Transport in *Escherichia coli* VIII. Potassium Transport Mutants, *The Journal of General Physiology* 67 (3) 325-341
- Roe AJ, McLaggan D, O'Byrne CP, and Booth IR, 2000, Rapid inactivation of the *Escherichia coli* Kdp K1 uptake system by high potassium concentrations, *Molecular Microbiology*, 35 (5) 1235-1243
- Schleyer M and Bakker EP, 1993, Nucleotide Sequence and 3'-End Deletion Studies Indicate that the K<sup>+</sup>-Uptake Protein Kup from *Escherichia coli* Is Composed of a Hydrophobic Core Linked to a Large and Partially Essential Hydrophilic C Terminus, *Journal of Bacteriology* 175 (21) 6925-69331
- Schleyer M, Schmid R and Bakker EP, 1993, Transient, specific and extremely rapid release of osmolytes from growing cells of *Escherichia coli* K-12 exposed to hypoosmotic shock, *Archives of Microbiology*, 160 (6) 424-431
- Schumann U, Edwards MD, Rasmussen T, Bartlett W, van West P, and Booth IR, 2010, YbdG in *Escherichia coli* is a threshold-setting mechanosensitive channel with MscM activity, *PNAS*, 107 (28) 12664-12669
- Sleator RD, Gahan CGM, and Hill C, 2001, Identification and Disruption of the proBA Locus in *Listeria monocytogenes*: Role of Proline Biosynthesis in Salt Tolerance and Murine Infection, *Applied and Environmental Microbiology*, 67 (6) 2571-2577
- Sleator RD and Hill C, 2001, Bacterial osmoadaptation: the role of osmolytes in bacterial stress and virulence, *FEMS Microbiological Reviews*, 26 (1) 49-71
- Sleator RD, Gahan CGM and Hill C, 2003, A postgenomic appraisal of osmotolerance in *Listeria monocytogenes*, *Applied and Environmental Microbiology*, 69 (1) 1-9
- Sleator RD, Gahan CGM, Abee T and Hill C, 1999, Identification and disruption of BetL, a secondary glycine betaine transport system linked to the salt tolerance of *Listeria monocytogenes* LO28, *Applied and Environmental Microbiology*, 65 (5) 2078-2083
- Sharfstein ST, Shen D, Kiel TR, and Zhou R, 2007, Molecular response to osmotic shock, In *Systems Biology 2007*, Volume 5 (Chapter 7), 213-236
- Storz G, Hengge-Aronis R, 2000, *Bacterial stress responses*, ASM Press
- Strøm AR and Kaasen I, 1993, Trehalose metabolism in *Escherichia coli*: stress protection and stress regulation of gene expression, *Molecular Microbiology*, 8 (2) 205-210
- Sukharev S, 2002, Purification of the Small Mechanosensitive Channel of *Escherichia coli* (MscS): the Subunit Structure, Conduction, and Gating Characteristics in Liposomes, *Biophysics Journal*, 83 (1) 290-298
- Townsend DE, and Wilkinson BJ, 1992, Proline Transport in *Staphylococcus aureus*: a High-Affinity System and a Low-Affinity System Involved in Osmoregulation, *Journal of Bacteriology*, 174(8) 2702-2710

Trchounian A, and Kobayashia H, 1999, Kup is the major K. uptake system in Escherichia coli upon hyper-osmotic stress at a low pH, FEBS Letters, 447 (2-3) 144-148

Wood JM, Bremerb E, Csonka LN, Kraemer R, Poolman B, van der Heide T, Smith LT, 2001, Osmosensing and osmoregulatory compatible solute accumulation by bacteria, Comparative Biochemistry and Physiology, 130 (3) 437-460

Proceedings of

# CERC2011

Collaborative European Research Conference



These proceedings are from CERC 2011, the inaugural Collaborative European Research Conference, which was initiated to foster research across all disciplines within European third level research and educational institutes. This issue contains high quality papers from diverse disciplines ranging from art to computer science



**h\_da**

HOCHSCHULE DARMSTADT  
UNIVERSITY OF APPLIED SCIENCES



Institiúid Teicneolaíochta Chorcaí  
Cork Institute of Technology

ISSN: 2220-4164